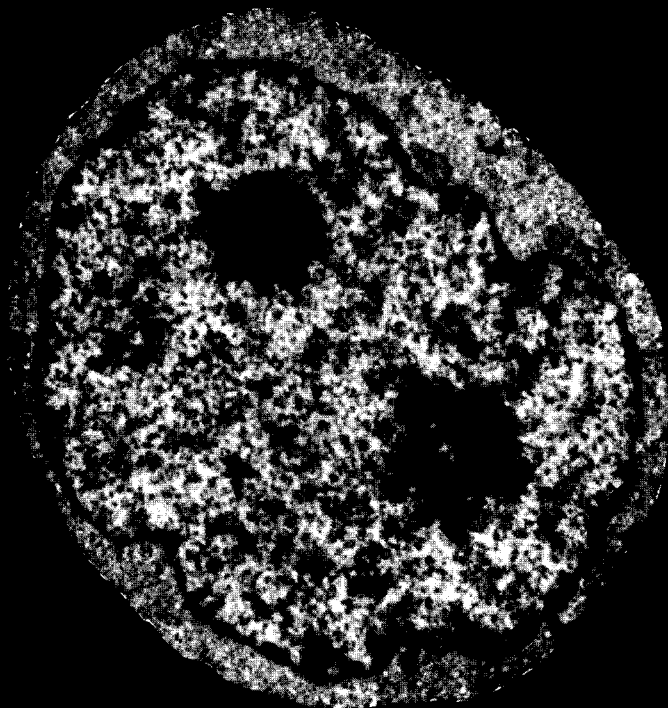


# AUTOLOGOUS BLOOD AND MARROW TRANSPLANTATION

Proceedings of the Tenth International Symposium  
Dallas, Texas



Edited by

KAREL A. DICKE & ARMAND KEATING



# **AUTOLOGOUS BLOOD AND MARROW TRANSPLANTATION**

**Proceedings of the Tenth International Symposium  
July, 2000  
Dallas, Texas**



# **AUTOLOGOUS BLOOD AND MARROW TRANSPLANTATION**

**Proceedings of the Tenth International Symposium  
Dallas, Texas**

**Edited by Karel A. Dicke and Armand Keating**

Published by



**CARDEN JENNINGS  
PUBLISHING**

Charlottesville, Virginia

ISBN 1-891524-08-9

©2001 by Carden Jennings Publishing Co., Ltd.

All Rights Reserved

Printed in the United States of America

The material contained in this volume was submitted as previously unpublished material except in instances in which credit has been given to the source.

Great care has been taken to maintain the accuracy of the information contained in the volume. However, the editorial staff cannot be held responsible for errors or for any consequences arising from the use of the information contained herein.

No part of this publication may be reproduced or transmitted in any form or by any means, electronic or mechanical, including photocopy, recording, or any information storage and retrieval system, without permission in writing from the publisher.

Carden Jennings Publishing Co., Ltd.

The Blake Center, Suite 200, 1224 West Main Street, Charlottesville, VA 22903 USA

## **ACKNOWLEDGMENTS**

We wish to thank Kathy White for her dedication and diligence in bringing this project to fruition and Willem Dicke for his expert editorial assistance.





## PREFACE

In just over two days, the Tenth International Symposium on Blood and Marrow Transplantation provided an outstanding and extraordinarily dynamic overview of the field, including new and exciting treatment modalities specifically targeted on tumor inhibition. The enthusiasm for the developing field of new strategies, such as tyrosine kinase inhibition, specific receptor blockers, and radiolabelled antibodies, was evident in the Symposium, and we hope that these Proceedings reflect our excitement.

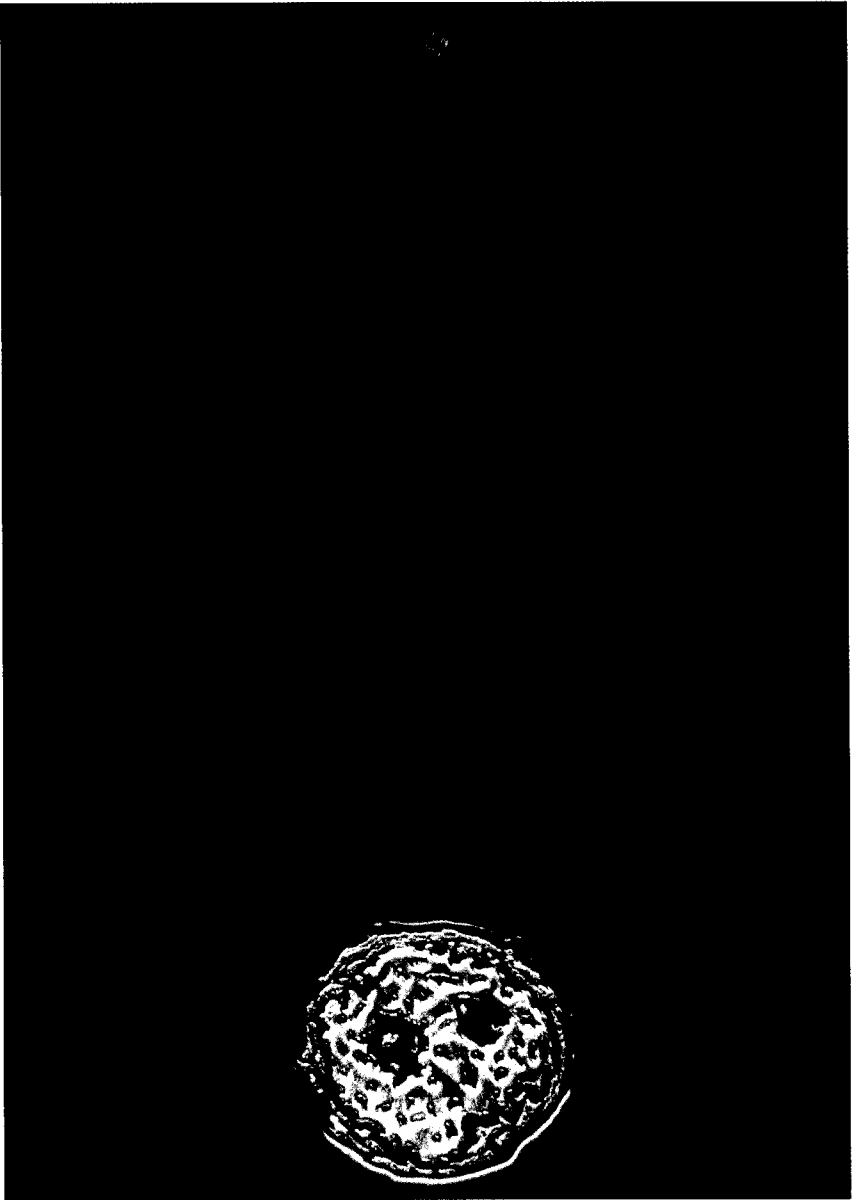
During the Symposium, Dr. Rainer Storb was honored as the fourth recipient of the van Bekkum Stem Cell Award, in recognition of his outstanding contributions to the field.

These Proceedings are dedicated to our colleague and beloved friend, Dr. George Santos, who contributed so much to medicine.

*Karel A. Dicke  
Arlington Cancer Center  
Arlington, Texas*

*Armand Keating  
The Toronto and Princess Margaret Hospitals  
University of Toronto  
Toronto, Ontario*

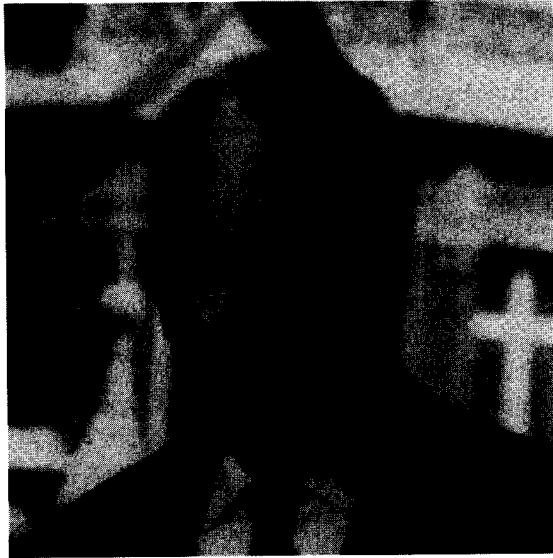




## **THE VAN BEKKUM STEM CELL AWARD**

Rainer Storb is the fourth recipient of this award that is bestowed on individuals who have made major contributions for a prolonged period of time to the field of hematopoietic stem cells and transplantation.





George W. Santos  
1928–2001

The Proceedings of the Tenth International Symposium on Autologous Blood and Marrow Transplantation, held in Dallas, Texas, July 2000, is dedicated to George Santos, MD, who died January 21, 2001, after a brave battle with cancer. We knew him for over three decades as a great professor and a very fine human being.

After George's graduation from MIT and a relatively short career in the U.S. Navy, it was medicine that became his intellectual and emotional focus. With his background in physics, it was no surprise that he chose a path in medicine where he could combine research and clinical medicine to bring the latest developments in the laboratory to the patient, and that hematopoiesis and transplantation of hematopoietic cells became his field in the sixties. On the basis of his research, he established the bone marrow transplant program in Johns Hopkins in the early seventies, and George and his team became key players in the development of bone marrow transplantation. His and his team's contributions, such as the world-renowned busulphan/cyclophosphamide conditioning regimen and the introduction of cyclosporine as prophylaxis of GVHD after transplantation, were milestones in the field of bone marrow transplantation.

George was one of the founders of the International Society of Experimental Hematology, and we will never forget the founding meeting held in one of the theaters in the middle of Paris in 1970 with Don Thomas, George Matthé, Derk van Bekkum, Rainer Storb, and thirty others. His heart was already set on how to prevent GVHD. He initiated many experimental programs in rodents; and, therefore, it was no surprise that it was George and his team who were first to recognize and develop the cyclosporine approach.

George attended the first five meetings of the ABMT symposia beginning in 1984. The contributions from him and his team were outstanding, especially the AML study in second remission with 4-HC purged marrow presented for the first time in 1986 at the third ABMT symposium.

When he retired in 1995, the bone marrow transplant unit in Johns Hopkins was among the leading programs in the world. He mentored many of the leaders in the field and on retiring he passed the torch to Dr. Rick Jones, who is keeping his legacy alive by continuing and renewing the program. His patients loved him because of his compassion and his positive and innovative thinking.

To his many friends and colleagues he will be remembered most for his generosity, his integrity, his persisting intellectual curiosity, and his extraordinary ability to translate laboratory findings to the clinic. He was a wise counselor and good friend to all his colleagues in the field he helped to create.

Thank you for what you did for medicine. It was a great journey!

Karel Dicke and Armand Keating

# TABLE OF CONTENTS

<b>CHAPTER 1: GRAFT ENGINEERING</b>	<b>1</b>
<b>Ex Vivo Expansion of Hematopoietic Cells: What Cells Are Needed?</b>	<b>3</b>
Ian McNiece, E.J. Shpall	
<b>Peptide-Pulsed Dendritic Cell Vaccinations for Treatment of Cancer</b>	<b>15</b>
Wolfram Brugger, Peter Brossart	
<b>Challenges in Autologous Graft Manipulation</b>	<b>19</b>
Adrian P. Gee	
<b>Clinical and Technical Considerations to Optimize Mobilization and Collection of Peripheral Blood Stem Cells</b>	<b>30</b>
D.L. Livingston, K.A. Dicke	
<b>CHAPTER 2: BREAST CANCER</b>	<b>39</b>
<b>High-Dose Chemotherapy in Breast Cancer in Europe: EBMT Database and Ongoing Trials</b>	<b>41</b>
Giovanni Rosti, Patrizia Ferrante, Felipe Prosper, John Crown, Claudio Dazzi, Maurizio Marangolo, on behalf of the European Group for Blood and Marrow Transplantation (EBMT) Solid Tumors Working Party Breast Cancer Registry	
<b>High-Dose Thiotepa, Mitoxantrone, and Paclitaxel Followed by Peripheral Blood Stem Cell Transplant for the Treatment of Chemosensitive Metastatic Breast Cancer: Clinical Outcomes</b>	<b>52</b>
Karen K. Fields, Janelle B. Perkins, Steve Goldstein, Daniel Sullivan, Teresa Field, Benjamin Djulbegovic, James Partyka	

<b>A New Approach Using Multiple High-Dose Ifosfamide, Carboplatin, and Etoposide (ICE) With Peripheral Blood Stem Cell Reinfusion for Chemoresistant Breast Cancer Patients After Neoadjuvant Treatment</b>	<b>62</b>
Giovanni Martinelli, Emilia Cocorocchio, Saverio Cinieri, Fedro Peccatori, Daniella Vaccari, Pier Francesco Ferrucci, Giovanni Mazzarol, Paolo Veronesi, Laura Baglietto, Francesco Bertolini, Aron Goldhirsch	
<b>High-Dose Chemotherapy in Breast Cancer: Current Status of Ongoing German Trials</b>	<b>71</b>
Nicolaus Kröger, William Krüger, Axel Rolf Zander	
<b>Intermediate High-Dose Chemotherapy in Metastatic Breast Cancer</b>	<b>76</b>
Karel A. Dicke	
<b>High-Dose Chemotherapy as an Integrated Program With Normal-Dose Chemotherapy and Irradiation in Poor-Prognosis Primary Breast Cancer</b>	<b>82</b>
Karel A. Dicke, George R. Blumenschein	
<b>Studies With the High-Dose Chemotherapy Regimen CTC (Cyclophosphamide, Thiotepa, and Carboplatin) in Breast Cancer</b>	<b>87</b>
Sjoerd Rodenhuis, Elisabeth G.E. de Vries, Jos H. Beijnen	
<b>Immunotherapy With Activated T Cells After High-Dose Chemotherapy and Peripheral Blood Stem Cell Transplantation for Breast Cancer</b>	<b>95</b>
Lawrence G. Lum	
<b>Summary of Current Studies in Breast Cancer Using High-Dose Chemotherapy and Autologous Blood Cell Transplantation, Including NCI-C CTG MA.16</b>	<b>106</b>
Stefan Glück, Michael Crump, Douglas Stewart, Andrew Arnold, Stephen Couban, Peter Kirkbride, Mark Levine, Susan O'Reilly, Kathleen Pritchard, Anne Smith, Dongsheng Tu, Janet Dansey, Susan Marlin, Lois Shepherd	



<b>Epirubicin/Paclitaxel Combination Mobilizes Adequate Amounts of Peripheral Blood Progenitor Cells to Support 3 Courses of High-Dose Dense Chemotherapy in Patients With Breast Cancer</b>	<b>113</b>
Ugo De Giorgi, Giovanni Rosti, Maurizio Marangolo	
<b>CHAPTER 3: SOLID TUMORS</b>	<b>119</b>
<b>High-Dose Chemotherapy With Autologous Stem Cell Rescue for the Treatment of Patients With Brain Tumors</b>	<b>121</b>
Sharon Gardner, Jonathan Finlay	
<b>High-Dose Chemotherapy and Autologous Stem Cell Transplantation for Ovarian Carcinoma as Part of Initial Therapy</b>	<b>127</b>
Patrick J. Stiff	
<b>High-Dose Therapy With Stem Cell Support for Small Cell Lung Cancer</b>	<b>135</b>
Anthony Elias	
<b>High-Dose Chemotherapy for Germ Cell Tumors: The European Point of View</b>	<b>151</b>
Giovanni Rosti, Patrizia Ferrante, Ugo De Giorgi, Helen Baldomero, Anna Cariello, Giorgio Papianni, Maurizio Marangolo	
<b>High-Dose Chemotherapy for Ovarian Cancer: Experience of the Solid Tumor Registry of the European Group for Blood and Marrow Transplantation</b>	<b>157</b>
Jonathan A. Ledermann	
<b>Autologous Stem Cell Transplantation for High-Risk Neuroblastoma</b>	<b>166</b>
Judith G. Villablanca, Katherine K. Matthay, C. Patrick Reynolds, Robert Gerbing, Daniel Stram, Robert C. Seeger	
<b>CHAPTER 4: AUTOIMMUNE DISEASE</b>	<b>181</b>
<b>Immunoablation Followed or Not by Hematopoietic Stem Cell Infusion as an Intense Therapy for Severe Autoimmune Diseases: New Perspectives, New Problems</b>	<b>183</b>
Alberto M. Marmont	

<b>Hematopoietic Stem Cell Transplantation in the Treatment of Severe Autoimmune Disease</b>	<b>203</b>
Alan Tyndall, on behalf of the European Group for Blood and Marrow Transplantation/European League Against Rheumatism and International Stem Cell Database	
<b>An Update of the Results of Autologous Stem Cell Transplantation in Treatment of Multiple Sclerosis</b>	<b>206</b>
Athanasios Fassas, for the EBMT Autoimmune Disease Working Party	
<b>High-Dose Immunosuppressive Therapy as Treatment for Severe Systemic Sclerosis</b>	<b>213</b>
Peter A. McSweeney, Daniel E. Furst, Richard A. Nash, Leona Holmberg, Federico Viganego, Kevin McDonough, Leslie Crofford, Roger Dansey, Maureen Mayes, Jan Storek, Gretchen Agee, Kathy Prather, Katherine Ryan, Keith M. Sullivan, for the National Collaborative Study for SCT in Autoimmune Diseases	
<b>Autologous Hematopoietic Stem Cell Transplant Conditioning Regimens for the Treatment of Severe Autoimmune Diseases</b>	<b>219</b>
Ashwin Kashyap, Jakob Passweg, Alan Tyndall	
<b>CHAPTER 5: POSTTRANSPLANT AND TARGETED THERAPY</b>	<b>227</b>
<b>Antibody-Targeted Therapy of Acute Myeloid Leukemia: An Update</b>	<b>229</b>
Dana C. Matthews, Eric L. Sievers, Frederick R. Appelbaum, Janet Eary, Katherine Ruffner, Irwin D. Bernstein	
<b>Nonmyeloablative Allografting Following a Failed Autograft</b>	<b>243</b>
Stephen Mackinnon	
<b>DNA Vaccination to Activate the Immune System Against Hematologic Malignancies</b>	<b>249</b>
T.J. Hamblin, J. Rice, C.A. King, S.S. Sahota, M.B. Spellerberg, F.K. Stevenson	
<b>Yttrium-90 Zevalin Radioimmunotherapy for Patients With Relapsed B-Cell Non-Hodgkin's Lymphoma (IDEC-Y2B8)</b>	<b>259</b>
Thomas E. Witzig	

<b>Posttransplant Immunotherapy for Multiple Myeloma Using Idiotype Vaccines</b>	<b>267</b>
Scott M. Schuetze, Barbara E. Smith, Donna Kelly, David G. Maloney	
<b>CHAPTER 6: NEW AVENUES</b>	<b>283</b>
<b>Optimization of Hematopoietic Stem Cell Gene Transfer Methods Using the Nonhuman Primate Competitive Repopulation Model: Recent Progress Toward Clinical Application</b>	<b>285</b>
J.F. Tisdale, S.A. Tuchman, T. Wu, H.J. Kim, S.E. Sellers, E.M. Kang, R.A. Donahue, C.E. Dunbar	
<b>The Clonal Activity of Transduced Autologous Repopulating Progenitor Cells</b>	<b>297</b>
Manfred Schmidt, Philipp Zickler, Gesa Hoffmann, Manuela Wissler, Hanno Glimm, Tong Wu, John Tisdale, Hyeoung Kim, Cynthia Dunbar, Christof von Kalle	
<b>A View of Myelodysplastic Syndrome as an Infectious Disease</b>	<b>302</b>
Azra Raza, Francesca Zorat, Fabiana Nascimben, Suneel Mundle, Vilasini Shetty, Poluru Reddy, Krishnan Allampallam, Sairah Alvi, Ahmad Shaher, Mona Tareen, Parameswaran Venugopal	
<b>CHAPTER 7: MINI-TRANSPLANTS</b>	<b>313</b>
<b>Nonmyeloablative Allografts: From the Laboratory to the Clinic</b>	<b>315</b>
Rainer Storb, Peter A. McSweeney, Brenda M. Sandmaier, Richard A. Nash, George Georges, David G. Maloney, Arthur Molina, Michael Maris, Ann Woolfrey, Thomas Chauncey, Jan M. Zaucha, Karl G. Blume, Judith Shizuru, Dietger Niederwieser	
<b>Mixed Lymphohematopoietic Chimerism and Delayed Donor Leukocyte Infusions Following Nonmyeloablative Conditioning and HLA-Matched and -Mismatched Donor Bone Marrow Transplantation</b>	<b>321</b>
Thomas R. Spitzer, Steven McAfee, Robert Sackstein, Christine Colby, Bimal Dey, Susan Saidman, Frederic Preffer, Steve Alexander, David H. Sachs, Megan Sykes	

<b>Minor Histocompatibility Antigens in Graft-vs.-Host Disease and Graft-vs.-Leukemia Reactions</b>	<b>333</b>
Stanley R. Riddell, Marc Gavin, Yoshiki Akatsuka, Makoto Murata, Philip D. Greenberg, Edus H. Warren	
<b>Nonmyeloablative Transplants to Deliver Allogeneic Immunotherapy for Malignant Disease</b>	<b>340</b>
John Barrett, Richard Childs	
<b>Fludarabine-Based Nonmyeloablative Transplantation for Hematologic Malignancies</b>	<b>346</b>
Issa Khouri, Sergio Giralt, Richard Champlin	
<b>Massive Doses of CD34+ Stem Cells Allow Significant Reduction in the Myeloablative Regimen Without Sacrificing Complete Chimerism in Matched Sibling Allogeneic Transplantation</b>	<b>354</b>
Karel A. Dicke, Jami Mayorga, Deborah L. Livingston, Sylvia Hanks, Lorene K. Fulbright	
<b>CHAPTER 8: ALL</b>	<b>359</b>
<b>Autologous Stem Cell Transplantation vs. Chemotherapy for Acute Lymphoblastic Leukemia in First Remission</b>	<b>361</b>
Jacob M. Rowe	
<b>Hematopoietic Stem Cell Transplantation as Treatment for Philadelphia Chromosome-Positive Acute Lymphoblastic Leukemia</b>	<b>372</b>
J. Sierra, L. Muñoz, M. Rovira, C. Canals, J.J. Ortega, T. Olivé, I. Badell, A. Julià, E. Carreras, S. Brunet, J.M. Ribera, E. Montserrat	
<b>Transplantation Therapy for Adults With Acute Lymphoblastic Leukemia: Comparative Analysis of Autologous and Unrelated Donor Bone Marrow Transplantation</b>	<b>380</b>
Daniel Weisdorf, Bernie Dharan, Mary Horowitz	

<b>CHAPTER 9: CML</b>	<b>385</b>
<b>Autografting With or Without Mobilized Hematopoietic Progenitor Cells in Chronic Myeloid Leukemia</b>	<b>387</b>
Angelo Michele Carella, Maria Teresa Corsetti, Enrica Lerma, Marina Cavaliere	
<b>STI571: A Tyrosine Kinase Inhibitor for the Treatment of CML: Validating the Promise of Molecularly Targeted Therapy</b>	<b>398</b>
Brian J. Druker	
<b>The Role of Megadose CD34<sup>+</sup> Cells in Haploidentical Transplantation for Leukemia: Potential Application for Tolerance Induction</b>	<b>401</b>
Massimo Martelli	
<b>CHAPTER 10: AML</b>	<b>405</b>
<b>Autologous Stem Cell Transplantation for Acute Myeloid Leukemia</b>	<b>407</b>
Charles A. Linker, Lloyd E. Damon, Curt A. Ries, Willis Navarro, Arnold Rubin, Delvyn Case, Pamela Crilley, David Topolsky, Isadore Brodsky, Ken Zamkoff, Jeffrey L. Wolf	
<b>Autologous Stem Cell Transplantation for Acute Myelocytic Leukemia in Patients &gt;60 Years of Age</b>	<b>422</b>
N.C. Gorin, M. Labopin, L. Fouillard, F. Frassoni, for the Acute Leukaemia Working Party of the European Group for Blood and Marrow Transplantation	
<b>Peripheral Blood Progenitor Cell Transplantation for Acute Myeloblastic Leukemia in First Remission</b>	<b>428</b>
Javier de la Rubia, M.A. Sanz	
<b>Treatment of Relapse After Autograft for Acute Leukemia in Remission</b>	<b>439</b>
L. Garderet, M. Labopin, L. Fouillard, F. Frassoni, N.C. Gorin, O. Ringden, for the Acute Leukemia Working Party of the European Group for Blood and Marrow Transplantation	

<b>Interleukin-2 After Autologous Stem Cell Transplantation for Acute Myelogenous Leukemia in First Complete Remission: The City of Hope Experience</b>	<b>450</b>
Anthony S. Stein, Margaret R. O'Donnell, Marilyn S. Slovak, Irena Sniecinski, Doni Woo, Jacqueline Hilger, Andrew Dagens, Nayana Vora, Daniel Arber, Stephen J. Forman	
 <b>CHAPTER 11: MULTIPLE MYELOMA</b>	<b>461</b>
<b>Novel Biologically Based Therapies for Multiple Myeloma</b>	<b>463</b>
Kenneth C. Anderson	
<b>Multiple Myeloma: Update on the Arkansas Experience—Year 2000</b>	<b>473</b>
Guido Tricot, Bart Barlogie	
<b>Advances in Allogeneic Transplantation for Multiple Myeloma Using Bone Marrow and Peripheral Blood Stem Cells</b>	<b>480</b>
G. Gahrton, H. Svensson, M. Cavo, J. Apperley, A. Bacigalupo, B. Bjorkstrand, J. Blade, J. Cornelissen, A. de Laurenti, T. Facon, P. Ljungman, M. Michallet, D. Niederwieser, R. Powles, J. Reiffers, N.H. Russell, D. Samson, U.W. Schaefer, A. Schattenberg, S. Tura, L.F. Verdonck, J.P. Vernant, R. Willemze, L. Volin, for the European Group for Blood and Marrow Transplantation	
<b>Feasibility of Dose-Dense Therapy of Multiple Myeloma With L-Phenylalanine Mustard</b>	<b>487</b>
Shahid Malik, Lawrence Lum, Amy Sharron, Mary Falvey, Deborah Morgan, Gerald Elfenbein	
 <b>CHAPTER 12: HODGKIN'S DISEASE</b>	<b>493</b>
<b>The Role of Sequential Radiation Therapy in High-Dose Therapy Protocols for Hodgkin's Disease</b>	<b>495</b>
Richard W. Tsang	
<b>The Importance of Salvage Chemotherapy Before High-Dose Therapy and Stem Cell Transplantation for Patients With Relapsed or Refractory Hodgkin's Disease</b>	<b>507</b>
Michael Crump, Todd Roberts, Armand Keating	

<b>Pretransplant Salvage Therapy for Hodgkin's Disease: Additional Toxicity With No Survival Benefit</b>	<b>519</b>
John W. Sweetenham	
<b>Allogeneic Stem Cell Transplantation in Patients With Hodgkin's Disease Who Relapse After Autologous Transplantation</b>	<b>534</b>
César O. Freytes, Fausto R. Loberiza, Tsuong W. Tsai, Koen van Besien, Donna E. Reece, Gordon L. Phillips, Philip J. Bierman, David H. Vesole, Gustavo Milone, Santiago Pavlovsky, Julie M. Vose, Hillard M. Lazarus, Mary M. Horowitz	
<b>Late Complications of Autologous Transplantation for Hodgkin's Disease</b>	<b>545</b>
J.D. Robertson, R. Chopra	
<b>New Strategies in Advanced-Stage Hodgkin's Lymphoma: The BEACOPP Regimen</b>	<b>560</b>
Jürgen Wolf, Andreas Engert, Jeremy Franklin, Ursula Paulus, Volker Diehl, for the German Hodgkin's Lymphoma Study Group	
<b>CHAPTER 13: LYMPHOMA</b>	<b>565</b>
<b>The Role of Autologous Transplantation in the Management of Mantle Cell Lymphoma: A Study From the EBMT</b>	<b>567</b>
E. Vandenbergh, C. Ruiz de Elvira, P. Isaacson, E. Lopez-Guillermo, E. Conde, C. Gisselbrecht, F. Guilhot, A. Goldstone, N. Schmitz	
<b>Involved-Field Radiation Therapy as an Adjunct to the Autotransplant Preparative Regimen for Lymphoma</b>	<b>573</b>
David P. Schenkein, Terry Boyle, Jody Morr, David E. Wazer, Julie Morelli, Hillard M. Lazarus, Kenneth B. Miller, Edward Stadtmauer, Andrew Pecora, Peter Cassileth	
<b>CD34<sup>+</sup>-Enriched Peripheral Blood Progenitor Cell Collections in Lymphoma Autotransplants Are Associated With Increased Morbidity</b>	<b>579</b>
Hillard M. Lazarus, Judah Friedman, Omer N. Koç	

<b>Engraftment After High-Dose Therapy for Lymphoma With Low Doses of CD34<sup>+</sup> Peripheral Blood Stem Cells and Ex Vivo Expanded Bone Marrow Cells</b>	<b>590</b>
Gerald Elfenbein, Shahid Malik, Andrew Pecora, Robert Preti, Mary Falvey, Deborah Morgan, Stuart Goldberg	
<b>CHAPTER 14: CORD BLOOD</b>	<b>597</b>
<b>Long-Term Engrafting Umbilical Cord Blood Cells Are Preserved After Ex Vivo Culture in Stroma-Free Culture</b>	<b>599</b>
K. Theunissen, I.D. Lewis, H. Liu, G. Almeida-Porada, J. Du, C. Scheller, A. Schmidt, I.R. Lemischka, K.A. Moore, J.E. Wagner, E.D. Zanjani, C.M. Verfaillie	
<b>Culture Conditions for Ex Vivo Expansion of Hematopoietic Primitive Cells</b>	<b>604</b>
L. Douay	
<b>CHAPTER 15: TUMOR CELL CONTAMINATION</b>	<b>615</b>
<b>Tumor Contamination of Transplanted Autologous Stem Cell Harvests and Outcome: Potential Confounding Impact of Stem Cell Dose</b>	<b>617</b>
J. Graham Sharp, James O. Armitage, Philip J. Bierman, Wing C. Chan, Anne Kessinger, James C. Lynch, Elizabeth C. Reed, Stefano Tarantolo, Monica Traystman, Julie M. Vose	
<b>Clinical Relevance of Micrometastases in Solid Tumors</b>	<b>629</b>
Klaus Pantel, Marcus Otte	
<b>Enhanced Detection of Breast Cancer Cells Following CD34<sup>+</sup> Cell Selection Combined With Tumor Cell Purging</b>	<b>640</b>
Amy A. Ross, Ginny Ofstein, Tamika Segura, Vu To, Peggie Mitsky, Bonnie Mills	
<b>Monitoring of Minimal Residual Disease in Breast Cancer Patients Treated With Adjuvant High-Dose Therapy and Stem Cell Support</b>	<b>653</b>
Gunnar Kvalheim, Jahn M. Nesland, Hilde Sommer, Gunn Anker, Helge Haarstad, Arne Kolstad, Bjørn Erikstein	



<b>The Prediction of Breast Cancer Contamination in Stem Cell Products by Immunocytochemical Analysis of Premobilized Peripheral Blood</b>	<b>662</b>
Tehila Umiel, Sebastian George, Robert Joyce, Thomas J. Moss	
<b>Reliable and Sensitive Analysis of Occult Bone Marrow Metastases Using Automated Cellular Imaging</b>	<b>672</b>
Kenneth D. Bauer, Jose de la Torre-Bueno, Ingo J. Diel, Debra Hawes, William J. Decker, Carl Priddy, Blaise Bossy, Susan Ludmann, Karen Yamamoto, Aneal S. Masih, Froilan P. Espinoza, Douglas S. Harrington	
<b>CHAPTER 16: SUMMARIES</b>	<b>689</b>
<b>Hematologic Malignancies</b>	<b>691</b>
John Barrett	
<b>Solid Tumors</b>	<b>697</b>
Patrick J. Stiff	
<b>List of Participants</b>	<b>702</b>
<b>Author Index</b>	<b>710</b>
<b>Key Word Index</b>	<b>713</b>



# LIST OF ABBREVIATIONS

## 0-9

4HC	hydroperoxycyclophosphamide
13-cRA	13- <i>cis</i> retinoic acid

## A

ABMTR	Autologous Blood and Marrow Transplant Registry
ABVD	doxorubicin, bleomycin, vinblastine, dacarbazine
ACD	acid-citrate-dextrose
ACIS	Automated Cellular Imaging System
AD	autoimmune disease
ADCC	antibody-dependent cell toxicity
AFM	doxorubicin, fluorouracil, methotrexate
AGC	absolute granulocyte count
AIDA	all- <i>trans</i> retinoic acid, idarubicin
AIDS	acquired immunodeficiency syndrome
AIHA	autoimmune hemolytic anemia
AITP	autoimmune thrombocytopenic purpura
ALL	acute lymphoblastic leukemia
alloBMT	allogeneic bone marrow transplantation
ALT	alanine transaminase
$\alpha$ -MEM	$\alpha$ -minimal essential medium
AML	acute myeloblastic leukemia acute myeloid leukemia
ANA	antinuclear antibody
ANC	absolute neutrophil count
APC	antigen-presenting cell
Ara-C	cytosine arabinoside
ASCO	American Society of Clinical Oncology
ASCR	autologous stem cell rescue
AST	aspartate transaminase
ATC	activated T cell
ATC	adriamycin, paclitaxel, cyclophosphamide
ATG	antithymocyte globulin
ATRA	all- <i>trans</i> retinoic acid

AUC	.....	.area under the curve
autoBMT	.....	.autologous bone marrow transplantation
autoPBSCT	.....	.autologous peripheral blood stem cell transplantation
autoSCT	.....	.autologous stem cell transplantation

**B**

BAVC	.....	.BCNU, amsacrine, idarubicin, cytosine arabinoside
BCAC	.....	.breast cancer antibody cocktail
BCNU	.....	.carmustine (nitrosourea)
BEACOPP	.....	.bleomycin, etoposide, doxorubicin, cyclophosphamide, vincristine, procarbazine, prednisone
BEAM	.....	.BCNU, etoposide, cytosine arabinoside, melphalan
bFGF	.....	.basic fibroblast growth factor
BFU-E	.....	.burst forming unit-erythroid
BGF	.....	.bovine growth hormone
BMC	.....	.bone marrow cell
BMSC	.....	.bone marrow stromal cells
BMT	.....	.bone marrow transplantation
BNLI	.....	.British National Lymphoma Investigation
BSA	.....	.bovine serum albumin
BSO	.....	.buthionine sulfoximine
BU CY	.....	.busulfan, cyclophosphamide

**C**

CAE	.....	.cyclophosphamide, doxorubicin, etoposide
CAF	.....	.cyclophosphamide, doxorubicin, fluorouracil
CAFC	.....	.cobblestone area-forming cell
CALGB	.....	.Cancer and Leukemia Group B
CAT	.....	.cyclophosphamide, adriamycin, paclitaxel
CAV	.....	.cyclophosphamide, doxorubicin, vincristine
CAVe	.....	.cyclophosphamide, adriamycin, etoposide
CBP	.....	.cyclophosphamide, carmustine, cisplatin
CBVA	.....	.cyclophosphamide, BCNU, etoposide, cytosine arabinoside
CCG	.....	.Children's Cancer Group

CDDP	.cisplatin
CDR	.complementarity-determining region
CEM-LI	.carboplatin, etoposide, melphalan, and local irradiation
CFA	.complete Freund's adjuvant
CFC	.colony-forming cell
CFU-GM	.colony-forming unit-granulocyte/macrophage
CFU-S	.spleen colony-forming unit
cGMP	.current good manufacturing practices
cGTP	.current good tissue practices
CHOP	.cyclophosphamide, adriamycin, vincristine
	.cyclophosphamide, doxorubicin, vincristine, prednisone
CI	.confidence interval
CK	.cytokeratin
CLL	.chronic lymphocytic leukemia
CMA	.cyclophosphamide, mitoxantrone, melphalan
CMF	.cyclophosphamide, methotrexate, fluorouracil
CML	.chronic myelogenous leukemia
	.chronic myeloid leukemia
CM	.conditioned medium
CMF	.cyclophosphamide, methotrexate, fluorouracil
CMV	.cytomegalovirus
CODE	.cyclophosphamide, vincristine, doxorubicin, etoposide
COG	.Children's Oncology Group
COPP	.cyclophosphamide, vincristine, procarbazine, prednisone
CP	.chronic phase
CPB	.cyclophosphamide, BCNU, cisplatin
CPG	.cyclophosphamide, prednisone, G-CSF
CR	.complete remission
	.complete response
CRP	.C-reactive protein
CsA	.cyclosporine, cyclosporin A
CSF	.colony-stimulating factor
CT	.computed tomography
CTC	.Common Toxicity Criteria
CTC	.cyclophosphamide, thiotepa, carboplatin
CTL	.cytotoxic T lymphocyte
CTX	.cyclophosphamide

CVAD	.cyclophosphamide, vincristine, adriamycin
CVP	.cyclophosphamide, etoposide, cisplatin
CY	.cyclophosphamide
CYP450	.cytochrome P450

**D**

DAB	.3,3-diaminobenzidine
DC	.dendritic cell
DCEP	.dexamethasone, cyclophosphamide, etoposide, cisplatin
DCFH-DA	.2',7'-dichlorofluorescein-diacetate
DFS	.disease-free survival
DHAP	.dexamethasone, cytosine arabinoside, cisplatin
DLCO	.pulmonary carbon monoxide diffusing capacity
DLI	.donor leukocyte infusion .donor lymphocyte infusion
DM	.defined medium
DMEM	.Dulbecco's modified Eagle's medium
DMSO	.dimethylsulfoxide
DNA-PKcs	.DNA-protein kinase catalytic subunit
DSB	.double-stranded DNA break
dsDNA	.double-strand DNA
dsICC	.double-immunostaining immunocytochemical

**E**

EBDIS	.European Breast Dose Intensity Study
EBMT	.European Group for Blood and Marrow Transplantation
EBV	.Epstein-Barr virus
ECM	.extracellular matrix
ECOG	.Eastern Cooperative Oncology Group
ED	.extensive disease
EDSS	.expanded disability status scale
EFS	.event-free survival
EICC	.tumor-enriched immunocytochemical
ELISA	.enzyme-linked immunosorbent assay
E-LTC-IC	.extended long-term culture-initiating cell
EP	.etoposide, cisplatin
Epo	.erythropoietin

EPTS	extension primer tag selection
ER	estrogen receptor
ES	Evans' syndrome
EULAR	European League Against Rheumatism

**F**

FAB	French-American-British
FAC	fluorouracil, adriamycin, cyclophosphamide
FACS	fluorescence-activated cell sorter/sorting
FAHCT	Foundation for the Accreditation of Hematopoietic Cell Therapy
FCS	fetal calf serum
FDA	US Food and Drug Administration
FEV <sub>1</sub>	1-second forced expiratory volume
FEC	fluorouracil, epirubicin, cyclophosphamide
FFTF	freedom from treatment failure
FITC	fluorescein isothiocyanate
FLAG-Ida	fludarabine, cytosine arabinoside, idarubicin
FLT	Flt-3 ligand
FrC	fragment C
FuMEP	fluorouracil, mitomycin, etoposide, and cisplatin

**G**

GABG	German Adjuvant Breast Cancer Study Group
G-CSF	granulocyte colony-stimulating factor
GINECO	Groupe Investigation National Etude Cancer Ovaive
GITMO	Gruppo Italiano Trapianti di Midollo Osseo
GM-CFC	granulocyte-macrophage colony-forming cell
GM-CSF	granulocyte-macrophage colony-stimulating factor
GMP	good manufacturing practices
GOG	Gynecological Oncology Group
GTP	good tissue practices
GVHD	graft-vs.-host disease
GVL	graft-vs.-leukemia
GVM	graft vs. malignancy
	graft vs. myeloma

**H**

HACA	.human anti-chimeric antibody
HAMA	.human anti-mouse antibody
HAQ	.health assessment questionnaire
HBV	.hepatitis B virus
HCV	.hepatitis C virus
HD	.high dose
	.Hodgkin's disease
HDCT	.high-dose chemotherapy
HDDCT	.high-dose dense chemotherapy
HDIT	.high-dose immunosuppressive therapy
HDS	.high-dose sequential
HGF	.hematopoietic growth factor
HHV	.human herpes virus
HIV	.human immunodeficiency virus
HPC	.hematopoietic progenitor cell
HPP-CFC	.high proliferative potential colony-forming cell
HPV	.human papilloma virus
HS-GAG	.heparin sulfate glycosaminoglycan
HSCT	.hematopoietic stem cell transplantation
HTLV	.human T-cell leukemia virus
HU	.hydroxyurea

**I**

IBCSG	.International Breast Cancer Study Group
IBMTR	.International Blood and Marrow Transplant Registry
ICC	.immunocytochemical
ICE	.ifosfamide, carboplatin, etoposide
ICSI	.intracytoplasmic sperm injection
Id	.idiotypic
ID	.induction chemotherapy
IDE	.investigational device exemption
IFM	.Intergroupe Français du Myelome
IFN	.interferon
IFRT	.involved-field radiation therapy
Ig	.immunoglobulin
IL	.interleukin



IMDM	.Iscove's modified Dulbecco's medium
IMiD	.immunomodulatory drug
IND	.investigational new drug
IP	.intraperitoneal
IPE	.ifosfamide, cisplatin, etoposide
IRB	.institutional review board
ISS	.immunostimulatory sequence
ITP	.idiopathic thrombocytopenic purpura
IV	.intravenous, intravenously
IVF	.in vitro fertilization

**J**

JCA	.juvenile chronic arthritis
JIA	.juvenile idiopathic arthritis

**K**

KS	.Kaposi's sarcoma
KLH	.keyhole limpet hemocyanin

**L**

LAK	.lymphocyte-activated killer
LD	.limited disease
	.low dose
LFS	.leukemia-free survival
LIF	.leukemia inhibitory factor
LM	.ligation mediated
LP	.leukapheresis product
LPS	.lipopolysaccharide
LTC-IC	.long-term culture-initiating cell
LTCM	.long-term culture medium
LVL	.large-volume leukapheresis

**M**

mAb	.monoclonal antibody
MACS	.magnetic cell separation
m-AMSA	.amsacrine
MAPK	.mitogen-activated protein kinase

MAS	.macrophage-activation syndrome
McCFUD	.cyclophosphamide, methotrexate, fluorouracil, dexamethasone, cisplatin
MCL	.mantle cell lymphoma
MCP	.monocyte chemoattractant protein
MCyR	.major cytogenetic remission
MDS	.myelodysplastic syndrome
MGDF	.megakaryocyte growth and development factor
MGF	.mast cell growth factor
mHAg	.minor histocompatibility antigen
MHC	.major histocompatibility complex
MIBG	.metaiodobenzylguanidine
MIP	.macrophage inflammatory protein
ML-IC	.myeloid/lymphoid-initiating cell
MLR	.mixed lymphocyte reaction
MLV	.murine leukemia virus
MM	.multiple myeloma
MMF	.mycophenolate mofetil
MNC	.mononuclear cell
MOPP	.mechlorethamine, vincristine, procarbazine, prednisone
MRC	.Medical Research Council
MRD	.minimal residual disease
MRI	.magnetic resonance imaging
MS	.multiple sclerosis
MTB	.mitoxantrone, thiotepa, BCNU
MTD	.maximum tolerated dose

**N**

NANT	.New Approaches to Neuroblastoma Therapy
NCI	.National Cancer Institute
NCIC-CTG	.National Cancer Institute of Canada Clinical Trials Group
NF $\kappa$ B	.nuclear factor $\kappa$ B
NHL	.non-Hodgkin's lymphoma
NIH	.National Institutes of Health
NIP	.noninfectious pulmonary
NK	.natural killer
NMDP	.National Marrow Donor Program
NS	.not significant

NST ..... nonmyeloablative allogeneic stem cell transplantation

## O

OM ..... occult metastasis  
 ORR ..... overall response rate  
 OS ..... overall survival

## P

PACE-BOM ..... prednisone, doxorubicin, cyclophosphamide, etoposide, bleomycin, vincristine, methotrexate  
 PB ..... peripheral blood  
 PBL ..... peripheral blood lymphocyte  
 PBMC ..... peripheral blood mononuclear cell  
 PBPC ..... peripheral blood progenitor cell  
 PBS ..... phosphate-buffered saline  
 PBSC ..... peripheral blood stem cell  
 PBSCT ..... peripheral blood stem cell transplantation  
 PCI ..... prophylactic cranial irradiation  
 PCL ..... plasma cell leukemia  
 PCR ..... polymerase chain reaction  
 PE ..... phycoerythrin  
 PF ..... platelet factor  
 PFS ..... progression-free survival  
 PGP 9.5 ..... protein gene product 9.5  
 Ph ..... Philadelphia chromosome  
 PLT ..... platelet count  
 PMA ..... phorbol myristate acetate  
 PMN ..... polymorphonuclear cell  
 pMS ..... progressive multiple sclerosis  
 PNET ..... primitive neuroectodermal tumor  
 PNH ..... paroxysmal nocturnal hemoglobinuria  
 PR ..... partial remission  
       ..... partial response  
 PRC ..... packed red cells  
 ProMACE-MOPP ..... cyclophosphamide, etoposide, doxorubicin, nitrogen mustard, procarbazine, vincristine, high-dose methotrexate  
 PSA ..... prostate-specific antigen

PSCC ..... peripheral stem cell collection

## **R**

RA ..... rheumatoid arthritis  
 RAFTK ..... related activated focal adhesion kinase  
 RCC ..... renal cell carcinoma  
 RCT ..... randomized controlled trial  
 REAL ..... Revised European American Lymphoma  
 RFLP ..... restriction fragment length polymorphism  
 RFS ..... recurrence-free survival  
 rh ..... recombinant human  
 RIT ..... radioimmunotherapy  
 RR ..... relative risk  
       ..... risk of relapse  
 RSS ..... Rodnan skin score  
 RT-PCR ..... reverse transcription–polymerase chain reaction

## **S**

SAA ..... severe aplastic anemia  
 SAD ..... severe autoimmune disease  
 SAM ..... sheep anti-mouse  
 SCF ..... stem cell factor  
 scFv ..... single-chain Fv  
 SCG ..... stem cell graft  
 SCLC ..... small cell lung cancer  
 SCT ..... stem cell transplantation  
 SD ..... standard deviation  
 SDCT ..... standard-dose chemotherapy  
 SHP2 ..... SH2-containing protein  
 SI ..... stimulation index  
 SLE ..... systemic lupus erythematosus  
 SLEDAI ..... SLE disease activity index  
 SMH ..... small marrow harvest  
 SRC ..... SCID repopulating cell  
 SSc ..... systemic sclerosis  
 STAMP V ..... cyclophosphamide, thiotepa, carboplatin  
 SVL ..... standard-volume leukapheresis  
 SWOG ..... Southwest Oncology Group

**T**

TAA	.tumor-associated antigens
TBI	.total body irradiation
TCD	.T-cell depleted
TCR	.T-cell receptor
TGF	.transforming growth factor
Th	.T helper
TIP	.paclitaxel, ifosfamide, cisplatin
TLI	.total lymphoid irradiation
TNCs	.total nucleated cells
TNF	.tumor necrosis factor
TNI	.total nodal irradiation
TNT	.mitoxantrone, thiotepa, paclitaxel
TPO	.thrombopoietin
TREC	.T-cell receptor–rearrangement excision circle
TRM	.treatment-related mortality .transplant-related mortality
TRT	.thoracic radiotherapy
TSP	.thrombospondin .tropical spastic paraparesis
TTP	.thrombotic microangiopathy .time to progression

**U**

UCSF	.University of California San Francisco
URD	.unrelated donor

**V**

VAPEC-B	.vinblastine, doxorubicin, prednisone, etoposide, cyclophosphamide, bleomycin
VEGF	.vascular endothelial growth factor
VIC	.etoposide, ifosfamide, carboplatin
VGPR	.very good partial remission
VNTR	.variable number of tandem repeats
VOD	.veno-occlusive disease
VP-16	.etoposide

**W**

- WBC .....white blood cell count
- WHO .....World Health Organization
- WSG .....Westdeutsche Study Group

**X**

- XCIP .....X-chromosome inactivation pattern

# **CHAPTER 1**

# **GRAFT ENGINEERING**





# **Ex Vivo Expansion of Hematopoietic Cells: What Cells Are Needed?**

*Ian McNiece, E.J. Shpall*

*BMT Program, University of Colorado Health Sciences Center,  
Denver, Colorado*

## **ABSTRACT**

Hematopoietic cells have the potential for providing clinical benefit in a variety of clinical settings. These include cells for support of patients undergoing high-dose chemotherapy, as a target for replacement gene therapy, and as a source of cells for immunotherapy, to name just a few. The limitation to many of these applications has been the total absolute number of defined populations of cells. Therefore, many investigators have explored methods to culture hematopoietic cells in vitro. A major question remains: which cell populations are responsible for rapid engraftment of neutrophils and platelets? Some reports have suggested that stem cells provide both short- and long-term engraftment. Alternatively, mature progenitors or late-stage cells are responsible for rapid engraftment, and stem cells are required for durable long-term engraftment. Clinical studies are currently in progress that explore the use of ex vivo expanded cells, and some of the data from these studies suggest that mature cells are responsible for rapid engraftment.

## **INTRODUCTION**

Ex vivo expansion of hematopoietic cells has been proposed for a number of clinical applications, including (1) supplementing stem cell grafts with more mature precursors to shorten or potentially prevent chemotherapy-induced pancytopenia; (2) obtaining a sufficient number of cells from a single marrow aspirate or apheresis procedure, thus reducing the need for large-scale harvesting of marrow or multiple leukaphereses; (3) generating sufficient cells from a single umbilical cord blood harvest to reconstitute an adult following high-dose chemotherapy; (4) purging stem cell products of contaminating tumor cells; and (5) increasing the number of target stem cells for gene therapy. Therefore, it is important to consider the clinical application when discussing ex vivo expansion approaches and to define culture conditions that are relevant to the particular cell type being expanded.

Historically, the different hematopoietic compartments have been thought to contribute to different aspects of blood cell production. Stem cells provide long-term engraftment, progenitor cells provide intermediate engraftment and may contribute to short-term engraftment, and mature cells provide short-term engraftment.<sup>1,2</sup> However, recent publications have claimed that stem cells alone are able to provide short-term, intermediate, and long-term engraftment. This would suggest that purified stem cells do it all! But how can this be? The literature teaches us that stem cells give rise to multipotential progenitor cells that further differentiate to generate committed progenitor cells and ultimately mature cells. The doubling time of a stem cell has been reported to be 16–20 hours. Furthermore, *in vitro* assays of committed progenitor cells demonstrate that committed progenitor cells under optimal *in vitro* conditions require at least 7 days to produce mature neutrophils. So how can a stem cell differentiate into progenitor cells and then to mature cells in 7 to 10 days? Obviously, this would require redefining many parameters that have been described in detail in many previous reports. The simple solution is that mature progenitor cells or mature cells are the cells that produce rapid hematopoietic engraftment, and therefore the previous dogmas still hold true.

### **SELF-RENEWAL OF STEM CELLS**

The focus of many groups has been to expand stem cells; however, to date no data have been published demonstrating significant expansion of stem cells. It is possible that under the culture conditions employed, stimulation of division of stem cells results in differentiation of the progeny cells compared to the parental cell and leads ultimately to maturation of the progeny cells. Several investigators have used *in vitro* assays such as the long-term culture–initiating cell assay,<sup>3</sup> the cobblestone area–forming cell assay,<sup>4</sup> and the high proliferative potential colony-forming cell (HPP-CFC) assay<sup>5</sup> as surrogate assays for stem cells. These assays measure a heterogeneous population of cells within a stem cell compartment. If true self-renewal of stem cells were capable *in vitro*, it would be possible to generate increased numbers of stem cells so that they could be further renewed and give rise to more stem cells. Some studies have shown an initial expansion of stem cell numbers based on the *in vitro* assays; however, repeated culture of these cells does not result in the generation of more stem cells, demonstrating the commitment of these cells and thus failing in the strict definition of self-renewal. Thus, one must be careful in interpreting data on self-renewal, as it is possible to generate increased numbers of cells that may have properties still within the stem cell compartment, but this process is associated with commitment and does not represent self-renewal.

## THE GENERATION-AGE HYPOTHESIS

It has been proposed by several studies<sup>6,7</sup> that the proliferative potential of a stem cell is inversely related to its generation-age within the stem cell population, whereas its cycling rate is directly related to its generation-age. A cell that has undergone few generations since its origin would thus be regarded as a young (more primitive) stem cell that has a higher proliferative capacity and cycles more slowly than an older (less primitive) stem cell that has undergone more generations.<sup>8,9</sup>

Alternatively, it has been proposed that stem cells have limited self-renewal capacity and that a sufficient number of stem cells are laid down during embryogenesis. These stem cells are maintained in a quiescent state until they are required for mature cell production. The proliferative capacity of the stem cells (up to 50 cell divisions) provides for the blood cell requirements for the normal life span of a human. Stress on the production of blood cells, such as multiple cycles of chemotherapy, may lead to exhaustion of the stem cell reserve. Clearly, there are many questions about the properties of human stem cells that remain to be answered that will provide important information on how to expand the numbers of stem cells for future clinical applications.

## DO STEM CELLS CONTRIBUTE TO SHORT-TERM ENGRAFTMENT?

Studies by Baum et al.<sup>10</sup> described human stem cells as CD34<sup>+</sup>Thy-1<sup>+</sup>Lin<sup>-</sup> phenotype. Following from these reports, several clinical studies were performed to evaluate the potential of these cells to support patients receiving high-dose chemotherapy. Two of these studies were recently published<sup>11,12</sup> and claimed that CD34<sup>+</sup>Thy-1<sup>+</sup>Lin<sup>-</sup> cells were capable of providing rapid engraftment of neutrophils and platelets. However, the data presented in those articles raise some questions about the validity of these claims. In the publication by Michallet et al.,<sup>11</sup> data are presented that 48.7% of the CD34<sup>+</sup> cells are Thy-1<sup>+</sup>. In other words, half of the CD34<sup>+</sup> cells are stem cells. This is much higher than would be expected for stem cell content and contrasts with other reports defining primitive cell populations as CD34<sup>+</sup>CD38<sup>-</sup> and CD34<sup>+</sup>HLA-DR<sup>-</sup>, which represent less than 10% of the CD34<sup>+</sup> population.<sup>13</sup> In addition, the levels of CD34<sup>+</sup>Thy-1<sup>+</sup> cells required for rapid engraftment are in the range of  $1 \times 10^6$  cells/kg. At these levels, it is more likely that significant numbers of progenitor cells are present, which are most likely responsible for the rapid engraftment. It can be concluded from these studies that CD34<sup>+</sup>Thy-1<sup>+</sup> cells contain stem cells; however, not all CD34<sup>+</sup>Thy-1<sup>+</sup> cells are stem cells.

## EXPANSION OF HEMATOPOIETIC CELLS BY GROWTH FACTORS

The first demonstration of the use of growth factors to generate increased numbers of specific cell populations was performed by Bradley et al.<sup>14</sup> in the early 1980s using crude conditioned medium (CM) as a source of hematopoietic growth factors (HGFs). In these studies, it was shown that incubation of postfluorouracil bone marrow cells in WEHI-3 CM for 7 days resulted in a 60-fold increase of primitive progenitor cells (13-day spleen colony-forming units [CFU-S<sub>13</sub>]) and a 53-fold increase in committed progenitor cells (granulocyte-macrophage colony-forming cells [GM-CFC]). In subsequent studies from this group, it was shown that preincubation with HGFs (also using crude CM) could expand primitive murine progenitor cells (HPP-CFC) and cells with *in vivo* marrow repopulating ability.<sup>15,16</sup> Using a similar culture system of human bone marrow cells in Teflon bottles, it was shown in 1988 that the combination of recombinant human granulocyte-macrophage colony-stimulating factor (rhGM-CSF) plus recombinant human interleukin-3 (rhIL-3) could generate a 7-fold increase in committed progenitor cells (GM-CFC).<sup>17</sup> In 1991, Bernstein et al.<sup>18</sup> showed that incubation of single CD34<sup>+</sup>Lin<sup>-</sup> cells in the combination of IL-3, granulocyte colony-stimulating factor (G-CSF), and stem cell factor (SCF) gave rise to a 10-fold increase of colonies *in vitro*.

The use of *ex vivo* expansion to generate mature neutrophil precursors was proposed in 1992 by Haylock et al.<sup>19</sup> These authors demonstrated that the combination of IL-1, IL-3, IL-6, GM-CSF, and SCF could generate a 1324-fold increase in nucleated cells and a 66-fold increase in GM-CFC. The cells produced under these conditions were predominantly neutrophil precursors. The culture conditions used were static and used CD34<sup>+</sup> cells as the starting population. Several investigators have demonstrated the requirement for CD34 selection of the starting cells for optimal expansion.<sup>19-22</sup> Subsequent studies were performed on a clinical scale using optimal culture conditions in Teflon bags with fully defined media appropriate for clinical applications.<sup>23</sup> This work used the growth factor cocktail comprising SCF, G-CSF, and megakaryocyte growth and development factor (MGDF).<sup>23</sup> Other cocktails of growth factors are effective in expanding CD34<sup>+</sup> cells; however, the availability of clinical-grade growth factors has been limited due to commercial considerations.

The *in vivo* potential of *ex vivo* expanded cells was first reported in murine studies by Muench et al.<sup>24</sup> This study demonstrated that bone marrow cells expanded in SCF plus IL-1 engrafted lethally irradiated mice and were capable of sustaining long-term hematopoiesis in these animals. In addition, the bone marrow from these engrafted mice could repopulate secondary recipients. The authors concluded that the expansion of mouse bone marrow cells did not adversely effect the proliferative capacity and lineage potential of the stem cell compartment.<sup>24</sup>

## PRECLINICAL STUDIES OF EX VIVO EXPANDED CELLS IN BABOONS

Recent studies in normal baboons have demonstrated the potential clinical benefit of ex vivo expanded cells. Andrews et al.<sup>25</sup> harvested peripheral blood progenitor cells (PBPCs) from G-CSF-mobilized normal baboons and expanded the CD34<sup>+</sup> cells for 10 days in SCF, G-CSF, and MGDF. After the culture period, the cells were washed and infused into the baboons after lethal irradiation. The fold expansion obtained was low compared with human CD34<sup>+</sup> cells and probably due to species variations of the growth factors and cell behavior in culture conditions developed for expansion of human cells. GM-CFC were expanded 7- to 8-fold.

Group IV, transplanted with expanded CD34<sup>+</sup> cells and given posttransplant G-CSF and MGDF, had a significantly shorter duration of neutropenia and significantly higher white blood cell count and polymorphonuclear cell nadirs compared with animals in the other groups. In fact, 2 of the 3 animals had no days with neutrophils <500/ $\mu$ L, a clinical end point used for neutrophil engraftment. In these studies, in vitro expansion did not influence platelet recovery, despite the use of MGDF in both cultures and after transplantation. Further studies will be needed to determine the culture conditions that will enhance platelet recovery of PBPCs.

An important point highlighted by these studies is the requirement for growth factors after the transplantation of the ex vivo expanded cells.<sup>25</sup> The animals in group II received expanded cells without growth factors posttransplant and had no significant improvement in engraftment compared with control animals. The animals in group IV that received expanded cells and growth factors posttransplant had faster recovery of neutrophils. We know that the culture of hematopoietic cells in vitro requires growth factors for survival and proliferation, and if we remove the growth factors, the cells go into an apoptotic state and die. It is possible that the transplantation of expanded cells in the absence of growth factor treatment of the recipients results in apoptosis of the expanded cells after infusion.

## EX VIVO EXPANDED PBPCs ENHANCE NEUTROPHIL RECOVERY IN BREAST CANCER PATIENTS

At the University of Colorado, we have treated patients ( $n = 21$ ) with high-risk stage II, III, or IV breast cancer using ex vivo expanded PBPCs.<sup>26,27</sup> All patients were mobilized with rhG-CSF (filgrastim; Amgen) 10  $\mu$ g/kg per day for 9 days and underwent leukapheresis on days 5 through 9. Following mobilization, all patients received high-dose chemotherapy. A group of historical control patients were identified with similar stage of disease, prior therapy, and high-dose chemotherapy regimens.

Leukapheresis products (LPs) were harvested on days 5 through 9, with CD34<sup>+</sup> cell selection performed on the first 4 LP. The fifth LP was frozen unselected as a

backup product. CD34<sup>+</sup> selection was performed using the Isolex 300i (Nexell, Irvine, CA). After selection, each product was frozen in liquid nitrogen. On day -10 of treatment, 2 LP were thawed and placed into *ex vivo* expansion culture. The cells were diluted in defined medium (DM) (Amgen) supplemented with 100 ng/mL each of rhSCF, rhMGDF, and rhG-CSF to 20,000 cells/mL in 800 mL of media and transferred into Teflon bags (American Fluoroceal). The bags were incubated at 37°C for 10 days in a 5% CO<sub>2</sub> incubator. On day 0 of treatment, the cultures were harvested using a cell washer (Cobe) and the media and growth factors removed with washing.

Following *ex vivo* expansion of the CD34-selected cells, patients in cohort 1 ( $n = 10$ ) were reinfused with expanded cells on day 0 followed by the unexpanded CD34<sup>+</sup> cells. Patients in cohort 2 ( $n = 11$ ) received only *ex vivo* expanded cells, and the unexpanded CD34<sup>+</sup> cells were maintained frozen in liquid nitrogen as a backup source of hematopoietic cells. The expanded PBPC autografts resulted in more rapid median time to engraftment of neutrophils ( $P = .02$  for both cohort 1 and 2 vs. the historical group) with a number of patients engrafting between days 4 and 6, compared with the earliest time of engraftment of day 7 in our historical controls ( $n = 100$ ). Analysis of the engraftment data of study and control patients by chemotherapy regimen demonstrated that the conditioning regimen did not influence the time to neutrophil engraftment. Similar improved rates of neutrophil engraftment have been reported by Reiffers et al.<sup>28</sup> using the same conditions employed in this study to culture the autologous PBPC fractions of myeloma patients. The patients in cohort 2 were transplanted with only expanded cells, and the patients are now >18 months posttransplant, with each patient maintaining a durable graft. These patients will be monitored long term to determine if the expansion of the cells compromises the long-term engrafting cells in these products. No effect on platelet recovery has been observed.

To date, the major predictor of time to engraftment for patients receiving nonexpanded PBPCs has been the number of CD34<sup>+</sup> cells/kg transplanted. Several studies using nonexpanded products have demonstrated that there is a correlation of the time to engraftment to the number of CD34 cells/kg infused up to a threshold level, above which even a 10-fold higher dose of CD34<sup>+</sup> cells does not result in faster recovery.<sup>29</sup> For neutrophil recovery, doses of CD34<sup>+</sup> cells/kg from 2 to  $2.5 \times 10^6$  up to  $20 \times 10^6$  CD34<sup>+</sup> cells/kg result in recovery of neutrophils at day 7 at the earliest.<sup>30</sup> We therefore evaluated the numbers of CD34<sup>+</sup> cells/kg from the expanded products reinfused in this study and a median of  $3.8 \times 10^6$  CD34<sup>+</sup> cells/kg and  $6.6 \times 10^6$  CD34<sup>+</sup> cells/kg were transplanted for cohorts 1 and 2, respectively. The total number of CD34<sup>+</sup> cells infused (expanded plus unexpanded products) for cohort 1 was a median of  $8.5 \times 10^6$  CD34<sup>+</sup> cells/kg. No significant correlation was obtained between the time to absolute neutrophil count (ANC)  $>500/\mu\text{L}$  and the dose of total CD34<sup>+</sup> cells/kg infused ( $r^2 = 0.24$ ). Similarly, the dose of expanded

CD34<sup>+</sup> cells/kg infused showed little correlation to the time to neutrophil engraftment ( $r^2 = 0.24$ ). However, comparison of the expanded total nucleated cells (TNCs)/kg to time to ANC recovery resulted in a highly significant correlation ( $r^2 = 0.79$ ). All patients who received a minimum of  $40 \times 10^6$  TNCs/kg engrafted neutrophils in 8 days or less. Patients who received  $<40 \times 10^6$  TNCs/kg all had slower neutrophil recovery (9 to 16 days). This level of TNC is lower than the minimal cell numbers recommended for unmanipulated bone marrow transplantation ( $2 \times 10^8$  MNCs/kg) and suggests that the expanded cell products contain a higher frequency of cells capable of providing rapid neutrophil engraftment. Alternatively, *ex vivo* culture regenerates these cells which are killed during the freezing of bone marrow (BM) or PBPCs used for autologous transplantation. These cells may be committed mature neutrophil precursors, which may be killed during freezing along with mature neutrophils. It will be of interest to evaluate the engraftment potential of *ex vivo* expanded allogeneic PBPC products where a direct comparison could be made to BM or PBPC that has not been cryopreserved.

### EX VIVO EXPANSION OF CORD BLOOD CELLS

Bone marrow transplantation (BMT) from HLA-matched related and unrelated donors has been successfully used to treat patients with hematologic malignancies. The major limitation to BMT is the availability of a suitable donor. The National Marrow Donor Program (NMDP) has identified a pool of 2 million potential donors, and as of December 1995, had facilitated ~4000 unrelated donor BM transplants. However, the availability of unrelated donor BM is still limited due to (1) the length of time for the donor search process (range, 1 month to 6 years),<sup>31</sup> (2) donor availability at the time of request, and (3) limited availability of donors in certain racial and ethnic populations. Because of these reasons, <40% of patients who could benefit from BMT have a suitable donor identified, and of those who do, <40% receive a transplant. Over the past 10 years, cord blood has been clinically investigated as an alternative source of hematopoietic tissue for allogeneic transplantation of patients lacking an HLA-matched marrow donor.<sup>32</sup> The first transplant using cord blood was performed by Gluckman et al. in 1989.<sup>33</sup>

The ease of collection and potential availability to groups that are underrepresented in the NMDP Registry are advantages of cord blood compared with BM. Also, it has been proposed that cord blood contains fewer T cells and/or more naive T cells than BM and may permit a greater degree of mismatch with less graft-vs.-host disease (GVHD).<sup>34</sup> The total number of cells in cord blood is low compared with BM or PBPC harvests; because of this, the vast majority of cord blood recipients have been children with an average weight of 20 kg. The progression-free survival rates reported thus far are comparable to the results achieved with

allogeneic BM transplantation, with a suggestion of decreased GVHD.<sup>35</sup> However, the time to neutrophil and platelet engraftment in cord blood recipients has been delayed compared with that of BM recipients.

Kurtzberg et al.<sup>36</sup> reported on 25 patients who received unrelated donor cord blood transplants. Twenty-three of the 25 transplant patients had evidence of donor engraftment, achieving an ANC  $>500/\mu\text{L}$  at a median of 22 days (range, 14–37 days) and platelet engraftment at a median of 56 days (range, 35–89 days). The overall event-free survival rate was 48% at a median follow-up of 12.5 months. In another report by Wagner et al.,<sup>37</sup> 18 patients with malignant and nonmalignant diseases received unrelated cord blood transplants. All patients demonstrated donor engraftment with an ANC  $>500/\mu\text{L}$  at a median of 24 days (range, 16–53 days) and platelet engraftment at a median of 54 days (range, 39–130 days). The probability of survival was 65% at a median follow-up of 6 months.

### **CORD BLOOD NUCLEATED CELL DOSE CORRELATES WITH NEUTROPHIL ENGRAFTMENT**

Gluckman et al.<sup>35</sup> have reported on the importance of the nucleated cell dose of the cord blood products transplanted. Higher nucleated cell dose was reported to have a positive impact on neutrophil engraftment, and one of the factors that predicted for better survival included a nucleated cell dose  $>3.7 \times 10^7/\text{kg}$ . These results have led to the recommendation of transplanting cord blood units only where the nucleated cell dose is  $>3.7 \times 10^7/\text{kg}$ . Obviously, this limits the number of patients who have an appropriate-sized graft, and therefore, the majority of cord blood transplants to date have been primarily in small pediatric patients.

### **CLINICAL STUDIES UTILIZING EX VIVO EXPANDED CORD BLOOD CELLS**

At the University of Colorado BMT Program we have transplanted cancer patients (chronic myeloid leukemia,  $n = 3$ ; chronic lymphoblastic leukemia,  $n = 3$ ; non-Hodgkin's lymphoma,  $n = 4$ ; acute lymphoblastic leukemia,  $n = 5$ ; acute myeloid leukemia,  $n = 1$ ; Hodgkin's disease,  $n = 1$ ; breast cancer,  $n = 2$ ) with ex vivo expanded cord blood. Patients who were appropriate candidates for high-dose chemotherapy requiring cellular support were eligible.<sup>38</sup> The cord blood products were frozen as a single product ( $n = 11$ ), in aliquots of  $2 \times 50\%$  ( $n = 2$ ), or in 40% and 60% aliquots ( $n = 6$ ). The cord blood products frozen in a single product were thawed on day 0 and 60% reinfused unmanipulated; the remaining 40% were CD34-selected and placed into ex vivo expansion culture. The other cord blood products were thawed at different times with a 50% or 40% aliquot thawed on day -10 for expansion culture and the remaining aliquot thawed on day 0 and reinfused



without manipulation. All fractions for expansion were CD34-selected using the Nexell Isolex 300i, and the CD34-selected cells were placed into a single Teflon bag (American Fluoroceal) containing 800 mL DM (Amgen) with 100 ng/mL each of rhSCF, rhG-CSF, and rhMGDF. The bags were incubated for 10 days in a 5% CO<sub>2</sub> incubator, after which time the cells were harvested, washed, and reinfused. Following transplantation, all patients received GVHD prophylaxis consisting of (1) cyclosporine 5 mg/kg intravenously (IV) 12 h starting day 2 and high-dose steroids ( $n = 8$ ) or (2) cyclosporine 5 mg/kg IV 12 h starting day 2 and moderate-dose steroids ( $n = 11$ ).

All patients achieved neutrophil engraftment and platelet engraftment, with median times of 25 days (range, 15 to 35 days) and 58 days (range, 27–91 days), respectively. Considering the low numbers of cells infused per kilogram in these patients, the time to neutrophil engraftment was faster than in previous reports of patients with weights >45 kg.<sup>35</sup>

Cytospins of the expanded cord blood cells demonstrated an immature phenotype with very few mature neutrophil cells visible. In contrast, expanded PBPCs contained mature segmented neutrophils and bands. We hypothesized that extended culture of cord blood cells would result in further maturation of cord blood cells and provide a product more similar to *ex vivo* expanded PBPCs. This expanded cord blood product may decrease the time to neutrophil engraftment when transplanted into patients. However, as the present expansion conditions used 10 days of culture without refeeding, extending the culture period under the current conditions resulted in decreased viability and overall expansion due to exhaustion of growth factors and media components, as demonstrated comparing 14 days in culture without refeeding to the 2-step conditions. Therefore, we evaluated the use of a 2-step culture approach designed to limit the cell manipulation required. CD34<sup>+</sup> cells were cultured in 50 mL DM plus SCF, G-CSF, and MGDF for 7 days. Following this incubation, the cells were transferred to 1-liter bags with DM plus the same growth factors and incubated for a further 7 days. A 4- to 5-fold increase in expansion of cord blood nucleated cells resulted with the 2-step culture conditions compared to the 10-day 1-step conditions. In addition, increased expansion of both committed and primitive progenitor cells was obtained with the 2-step conditions. Of particular note was the increased expansion of CD34<sup>+</sup> cells, with a median 29-fold increase in total CD34<sup>+</sup> cells after 14-day culture in the 2-step conditions. In the clinical studies performed to date, the median expansion of CD34<sup>+</sup> cells was only 5-fold.<sup>26</sup> These data suggest that the 2-step culture conditions may be more effective in expanding CD34<sup>+</sup> cells than the 1-step cultures. We are currently modifying our clinical protocol to incorporate the culture conditions for clinical application.

## CONCLUSIONS

The studies outlined above demonstrate the potential clinical utility of ex vivo expanded cells. The optimal growth factor cocktails for expansion of different cell types is yet to be determined. Several studies show a very significant effect on neutrophil engraftment; however, it is still unclear what cells are responsible for this more rapid recovery. Studies are needed to determine how to evaluate expanded products to define the cell type that leads to more rapid neutrophil engraftment. Also, culture conditions still need to be identified that will allow for the expansion of a megakaryocytic/platelet precursor that will provide more rapid platelet engraftment. In summary, there are exciting clinical results that suggest expanded cells have a major application in cellular support for high-dose chemotherapy. Further clinical studies are needed to better define what cells are required and what culture conditions will enable suitable expansion of these cell types.

## REFERENCES

1. Williams WJ, Beutler E, Erslev AJ, Lichtman MA, eds. *Hematology*, 4th ed. New York, NY: McGraw-Hill, 1990.
2. Kay HEM. How many cell-generations? *Lancet* August 28, 1965.
3. Sutherland HJ, Lansdorp PM, Henkelman DH, Eaves AC, Eaves CJ. Functional characterization of individual human hematopoietic stem cells cultured at limiting dilution on supportive marrow stromal layers. *Proc Natl Acad Sci U S A* 87:3584–3588, 1990.
4. Breems DA, Blokland EAW, Neben S, Ploemacher RE. Frequency analysis of human primitive haematopoietic stem cell subsets using a cobblestone area forming cell assay. *Leukemia* 8:1095–1104, 1994.
5. McNiece IK, Bertoncetto I, Krieglger AB, Quesenberry PJ, Zsebo KM. Colony-forming cells with high proliferative potential (HPP-CFC). In: Murphy MJ Jr, ed. *Concise Reviews in Clinical and Experimental Hematology*. Dayton, OH: AlphaMed Press, 1992, p. 267–277.
6. Rosendaal M, Hodgson GS, Bradley TR. Haematopoietic stem cells are organized for use on the basis of their generation-age. *Nature* 264:68–69, 1976.
7. Botnick LE, Hannon EC, Hellman S. Nature of the hematopoietic stem cell compartment and its proliferative potential. *Blood Cells* 5:195–210, 1979.
8. Schofield R. The relationship between the spleen colony-forming cell and the hematopoietic stem cell. *Blood Cells* 4:7–25, 1978.
9. Potten CS, Schofield R, Lajtha LG. A comparison of cell replacement in bone marrow, testis and three regions of surface epithelium. *Biochim Biophys Acta* 560:281–299, 1979.
10. Baum CM, Weissman IL, Tsukamoto AS, Buckle AM, Epaullet B. Isolation of a candidate human hematopoietic stem-cell population. *Proc Natl Acad Sci U S A* 89:2804–2808, 1992.
11. Michallet M, Philip T, Philip I, et al. Transplantation with selected autologous peripheral blood CD34<sup>+</sup>Thy-1<sup>+</sup> hematopoietic stem cells (Whisks) in multiple myeloma: impact of HSC dose on engraftment, safety, and immune reconstitution. *Exp Hematol* 28:

- 858–870, 2000.
12. Negrin RS, Atkinson K, Leemhuis T, et al. Transplantation of highly purified CD34<sup>+</sup>Thy-1<sup>+</sup> hematopoietic stem cells in patients with metastatic breast cancer. *Biol Blood Marrow Transplant* 6:262–271, 2000.
  13. Briddell R, Stoney G, Schuster L, et al. Primitive hematopoietic progenitor cell in peripheral blood harvests of patients mobilized with rhSCF plus rhG-CSF [abstract]. *Exp Hematol* 23:751a, 1995.
  14. Bradley TR, Hodgson GS, Kriegler AB, McNiece IK. Generation of CFU-S<sub>13</sub> in vitro. In: Cronkite EP, Dainiak N, McCaffrey RP, Palek J, Quesenberry PJ, eds. *Hematopoietic Stem Cell Physiology*. New York, NY: Alan R. Liss, 1985, p. 39–56.
  15. McNiece IK, Bradley TR, Kriegler AB, Hodgson GS. Subpopulations of mouse bone marrow high-proliferative-potential colony-forming cells. *Exp Hematol* 14:856–860, 1986.
  16. McNiece IK, Williams NT, Johnson GR, Kriegler AB, Bradley TR, Hodgson GS. Generation of murine hematopoietic precursor cells from macrophage high-proliferative-potential colony-forming cells. *Exp Hematol* 15:972–977, 1987.
  17. McNiece IK, Andrews RG, Stewart FM, Quesenberry PJ. Synergistic interactions of human growth factors in in vitro cultures of human bone marrow cells [abstract]. *Blood* 72 (Suppl 1):125a, 1987.
  18. Bernstein ID, Andrews RG, Zsebo KM. Recombinant human stem cell factor enhances the formation of colonies by CD34<sup>+</sup> and CD34<sup>+</sup>lin<sup>-</sup> cells, and the generation of colony-forming cell progeny from CD34<sup>+</sup>lin<sup>-</sup> cells cultured with interleukin-3, granulocyte colony-stimulating factor, or granulocyte-macrophage colony-stimulating factor. *Blood* 77:2316–2321, 1991.
  19. Haylock DN, To LB, Dowse TL, Juttner CA, Simmons PJ. Ex vivo expansion and maturation of peripheral blood CD34<sup>+</sup> cells into the myeloid lineage. *Blood* 80:1405–1412, 1992.
  20. Purdy MH, Hogan CJ, Hami L, et al. Large scale ex vivo expansion of CD34-positive hematopoietic progenitor cells for transplantation. *J Hematother* 4:515–525, 1995.
  21. Briddell RA, Kern BP, Zilm KL, Stoney GB, McNiece IK. Purification of CD34<sup>+</sup> cells is essential for optimal ex vivo expansion of umbilical cord blood cells. *J Hematother* 6:145–150, 1997.
  22. Shieh J-H, Chen Y-F, Briddell R, Stoney G, McNiece I. High purity of blast cells in CD34 selected populations are essential for optimal ex vivo expansion of human GM-CFC [abstract]. *Exp Hematol* 22:756a, 1994.
  23. Stoney GB, Briddell RA, Kern BP, Zilm KL, McNiece IK. Clinical scale ex vivo expansion of myeloid progenitor cells and megakaryocytes under GMP conditions [abstract]. *Exp Hematol* 24:1043a, 1996.
  24. Muench MO, Firpo MT, Moore MAS. Bone marrow transplantation with interleukin-1 plus kit-ligand ex vivo expanded bone marrow accelerates hematopoietic reconstitution in mice without the loss of stem cell lineage and proliferative potential. *Blood* 81: 3463–3473, 1993.
  25. Andrews RG, Briddell RA, Gough M, McNiece IK. Expansion of G-CSF mobilized CD34<sup>+</sup> peripheral blood cells (PBC) for 10 days in G-CSF, MGDF and SCF prior to transplantation decreased posttransplant neutropenia in baboons [abstract]. *Blood* 90 (Suppl 1):92a, 1997.

Abstract 10.

26. McNiece I, Hami L, Jones R, et al. Transplantation of ex vivo expanded PBPC after high dose chemotherapy results in decreased neutropenia [abstract]. *Blood* 92 (Suppl 1):126a, 1998.
27. McNiece I, Jones R, Bearman S, et al. Ex vivo expanded peripheral blood progenitor cells provide rapid neutrophil recovery after high-dose chemotherapy in patients with breast cancer. *Blood* 96:3001–3007, 2000.
28. Reiffers J, Cailliot C, Dazey B, Attal M, Caraux J, Boiron JM. Abrogation of post-myeloablative chemotherapy neutropenia by ex-vivo expanded autologous CD34-positive cells. *Lancet* 354:1092–1093, 1999.
29. Ketterer N, Salles G, Raba M, et al. High CD34+ cell counts decrease hematologic toxicity of autologous peripheral blood progenitor cell transplantation. *Blood* 91:3148–3155, 1998.
30. Weaver CH, Hazelton B, Birch R, et al. An analysis of engraftment kinetics as a function of CD34 content of peripheral blood progenitor cell collections in 692 patients after the administration of myeloablative chemotherapy. *Blood* 86:3961–3969, 1995.
31. Howard MR, Gore SM, Hows JM, et al. A prospective study of factors determining the outcome of unrelated marrow donor searches: report from the International Marrow Unrelated Search and Transplant Study Working Group on behalf of collaborating centers. *Bone Marrow Transplant* 13:389–396, 1994.
32. Cairo MS, Wagner JE. Placental and/or umbilical cord blood: an alternative source of hematopoietic stem cells for transplantation. *Blood* 90:4665–4678, 1997.
33. Gluckman E, Broxmeyer HE, Auerbach AD, et al. Hematopoietic reconstitution in a patient with Fanconi's anemia by means of umbilical cord blood from an HLA-identical sibling. *N Engl J Med* 321:1174–1178, 1989.
34. de La Selle V, Gluckman E, Bruley-Rosset M. Newborn blood can engraft adult mice without inducing graft-versus-host disease across non H-2 antigens. *Blood* 87:3977–3783, 1996.
35. Gluckman E, Rocha V, Boyer-Chammard A, et al. Outcome of cord-blood transplantation from related and unrelated donors. *N Engl J Med* 337:373–381, 1997.
36. Kurtzberg J, Laughlin M, Graham ML, et al. Placenta blood as a source of hematopoietic stem cells for transplantation into unrelated recipients. *N Engl J Med* 335:157–166, 1996.
37. Wagner JE, Rosenthal J, Sweetman R, et al. Successful transplantation of HLA-matched and HLA-mismatched umbilical cord blood from unrelated donors: analysis of engraftment and acute graft-versus-host disease. *Blood* 88:795–802, 1996.
38. Shpall EJ, Quinones R, Hami L, et al. Transplantation of cancer patients receiving high dose chemotherapy with ex vivo expanded cord blood cells [abstract]. *Blood* 92 (Suppl.1):646a, 1998.

# **Peptide-Pulsed Dendritic Cell Vaccinations for Treatment of Cancer**

**Wolfram Brugger, Peter Brossart**

*University of Tübingen, Medical Center II, Department of Hematology,  
Oncology, Immunology, and Rheumatology, Tübingen, Germany*

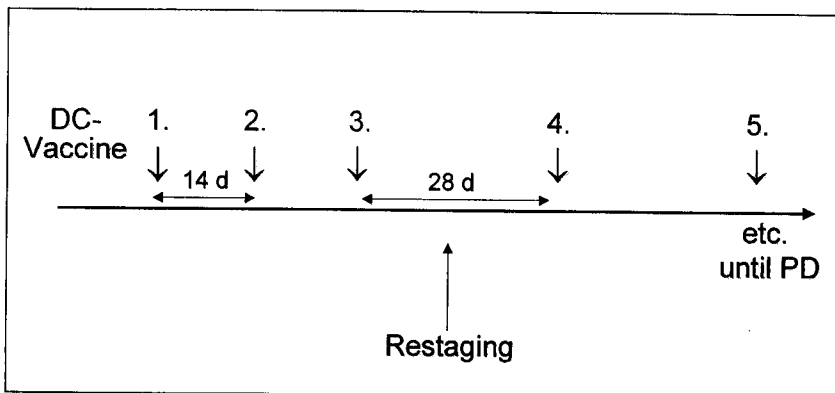
The identification of tumor-associated antigens (TAA) has provided new opportunities for the treatment of patients with malignant disease. For the potential treatment of breast and ovarian cancer, however, only a few T-cell epitopes have been identified, including those derived from the HER-2/neu protooncogene and the epithelial mucin MUC1. HER-2/neu is overexpressed in 20–30% of patients with breast and ovarian cancer and correlates with a poor prognosis. Two HLA-A2 binding peptides (E75 and GP2) derived from the HER-2/neu protein have been identified, and *in vitro* studies in our laboratory using these peptides for CTL induction demonstrated that these epitopes efficiently elicit antigen-specific T-cell responses against a variety of solid tumors, including renal cell and colon carcinoma, when loaded on dendritic cells (DCs). In contrast to the restricted expression of HER-2/neu, the MUC1 protein is overexpressed on more than 90% of breast and ovarian cancer and is therefore a suitable candidate for broadly applicable vaccine therapies. Mucins are transmembrane type I glycoproteins with a unique extracellular domain consisting mostly of 20 to 60 tandem repeats (variable number of tandem repeats [VNTR]). We recently identified 2 novel 9-mer peptides, M1.1 and M1.2, with a high binding probability to HLA-A2; the M1.1 peptide is derived from the VNTR domain of the MUC1 protein, and the M1.2 peptide is located in the leader sequence. Cytotoxic T lymphocytes (CTL) induced with these peptides efficiently lysed target cells pulsed with the cognate peptide or tumor cells naturally expressing MUC1 in a major histocompatibility complex (MHC)-restricted and antigen-specific manner.

Dendritic cells are the most potent antigen-presenting cells, with the unique ability to initiate and maintain primary immune responses when pulsed with antigens. They originate from the bone marrow, and their precursors migrate via the bloodstream to almost all organs, where they can be found in an immature state characterized by a high rate of antigen uptake. Upon stimulation with bacterial products, cytokines, or CD40 ligation, DCs undergo characteristic modulations of the phenotype, antigen-presenting function, and ability to migrate to the secondary lymphoid organs. These mature DCs express high levels of costimulatory and MHC molecules and are regarded as the initiators of primary immune responses. In

vitro, DCs can develop from peripheral blood CD14<sup>+</sup> monocytes when grown in the presence of granulocyte-macrophage colony-stimulating factor (GM-CSF) and interleukin (IL)-4. These cells have the characteristics of immature DCs and can be further induced to mature by inflammatory stimuli such as tumor necrosis factor (TNF)- $\alpha$ , IL-1, lipopolysaccharide (LPS), or CD40 ligation.

Vaccinations using DCs pulsed with TAA were shown to be effective for patients with B-cell lymphoma and malignant melanoma for which spontaneous remissions due to immunologic reactions as well as responses to immunotherapy-based treatments were reported. In contrast, no clinical and immunological responses have been reported in less immunogenic tumors such as breast and ovarian cancer. Therefore, we analyzed the feasibility and efficacy of HER-2/neu- or MUC1 peptide-pulsed DC vaccinations in patients with metastatic breast and ovarian cancer refractory to previous treatment including several chemotherapies, radiation, and hormone therapies. DCs were generated from peripheral blood monocytes in serum-free medium using GM-CSF, IL-4, and TNF- $\alpha$ . After 7 days of culture, DCs were pulsed with the antigenic peptides and injected subcutaneously (Figure 1). Ten patients were included in this pilot study. Each patient received approximately  $6 \times 10^6$  DCs per vaccination (range, 2 to  $17 \times 10^6$  DCs).

In the present study, we show for the first time that a vaccination approach using HLA-A2-restricted HER-2/neu- or MUC1 peptide-pulsed DCs can safely be applied in patients with advanced metastatic breast and ovarian cancer. No side effects were observed in these patients—particularly, no clinically relevant anemia—although we have shown recently that normal erythroid bone marrow progenitor and precursor cells coexpress MUC1 molecules. However, most of the more mature erythroid progenitor cells are MHC class I-negative and are therefore not targets for



**Figure 1.** Pilot study with HER-2/neu or MUC1 peptide-pulsed dendritic cells (DCs). PD, progressive disease.

MUC-1 peptide-specific CTLs. In addition, no autoimmune phenomena were observed in our study patients upon vaccination with these self peptides.

In 5 of 10 patients, peptide-specific CTLs could be detected in the peripheral blood after 3 vaccinations using both intracellular interferon (IFN)- $\gamma$  staining and standard  $^{51}\text{Cr}$ -release assays. The major CTL response in vivo was induced with the HER-2/neu-derived E75 and the MUC1-derived M1.2 peptide, suggesting that these peptides might be immunodominant. In addition, in 1 patient vaccinated with the MUC1-derived peptides, CEA- and MAGE-3 peptide-specific T-cell responses were detected after several vaccinations. In a second patient immunized with the HER-2/neu peptides, MUC1-specific T lymphocytes were induced after 7 immunizations, suggesting that antigen spreading in vivo might occur after successful immunization with a single tumor antigen. One possible explanation for this phenomenon is that the destruction of the tumor cells by the in vivo-induced peptide-specific T-cells leads to the induction of other tumor antigen-specific CTLs as a result of tumor cell uptake and processing by APCs, such as DCs or macrophages that were demonstrated to be involved in the cross-priming phenomenon.

In summary, we have shown here that vaccination therapy using DCs pulsed with HER-2/neu- or MUC1-derived peptides can be effective in patients with advanced metastatic breast and ovarian cancer. Immunological responses were induced in patients with advanced diseases that had been pretreated by multiple cycles of chemotherapy including high-dose chemotherapy and autologous stem cell transplantation, indicating that peptide-pulsed DC vaccinations could also be successfully applied after intensive or even high-dose chemotherapy to eliminate minimal residual disease. Furthermore, this study may be relevant to the design of future clinical studies for the treatment of a variety of other tumors expressing HER-2/neu or MUC1, including renal cell carcinoma, non-small cell lung cancer, and colon and pancreatic carcinoma.

## REFERENCES FROM OUR GROUP

- Brossart P, Goldrath AW, Butz EA, Martin S, Bevan MJ. Virus-mediated delivery of antigenic epitopes into dendritic cells as a means to induce CTL. *J Immunol* 158:3270–3276, 1997.
- Brossart P, Bevan MJ. Presentation of exogenous antigens on MHC class I molecules by dendritic cells: pathway of presentation and regulation by cytokines. *Blood* 90:1594–1599, 1997.
- Brossart P, Stuhler G, Flad T, et al. HER-2/neu-derived peptides are tumor-associated antigens expressed by human renal cell and colon carcinoma lines and are recognized by in vitro induced specific cytotoxic T lymphocytes. *Cancer Res* 58:732–736, 1998.
- Brossart P, Grünebach F, Stuhler G, et al. Generation of functional human dendritic cells from adherent peripheral blood monocytes by CD40 ligation in the absence of granulocyte-

macrophage colony-stimulating factor. *Blood* 92:4238–4247, 1998.

Brossart P, Heinrich KS, Stuhler G, et al. Identification of HLA-A2-restricted T-cell epitopes derived from the MUC1 tumor antigen for broadly applicable vaccine therapies. *Blood* 93:4309–4317, 1999.

Brugger W, Bühring HJ, Grünebach F, et al. Expression of MUC-1 epitopes in normal bone marrow: implications for the detection of micrometastatic tumor cells. *J Clin Oncol* 17:1574–1581, 1999.

Brossart P, Wirths S, Stuhler G, Reichardt VL, Kanz L, Brugger W. Induction of cytotoxic T-lymphocyte responses in vivo after vaccinations with peptide-pulsed dendritic cells. *Blood* 96:3102–3108, 2000.



# Challenges in Autologous Graft Manipulation

**Adrian P. Gee**

*Center for Cell and Gene Therapy, Baylor College of Medicine, Houston, Texas*

## ABSTRACT

Ex vivo processing of autologous cells for hematopoietic rescue poses numerous challenges to physicians, scientists, and technologists. These challenges include choosing the source of the graft, monitoring tumor involvement, determining whether to purge tumor cells from the graft and what purging method to use, quantitating purging efficacy, evaluating hematopoietic potential in vitro, utilizing cryopreservation techniques and posttransplant immunotherapy, and complying with an evolving strategy on how to regulate these technologies.

Although the addition of growth factors to chemotherapy regimens has improved the reproducibility of blood progenitor cell mobilization kinetics, it is clear that it is generally more difficult to harvest cells from patients than from normal donors. There are data to suggest that comobilization of tumor cells may occur, which becomes of increasing concern in poor mobilizers, in whom large numbers of aphereses must be used to achieve a target CD34<sup>+</sup> cell dose.

The impact of purging on clinical outcome is still disputed, although emerging data show a trend toward benefit. Techniques have generally moved from negative selection to a combination of enrichment of CD34<sup>+</sup> cells and tumor-directed negative selection. This can add \$5000 to \$15,000 to the cost of processing, at a time when managed health care is “unwilling to underwrite research” and has capitated transplantation costs. Molecular purging approaches are now appearing, but are unlikely to be less costly.

Central to evaluating the use of purging is accurate quantitation of tumor involvement. Substantial progress has been made in this area with the use of high-sensitivity immunocytochemical and molecular biology techniques. These should allow us to study, in a more quantitative fashion, the relationship between graft contamination, purging efficacy, and clinical outcome. Evaluation of engraftment potential in vitro and cryopreservation techniques have been under-studied, although they could radically improve or simplify autograft processing.

Resurgence of interest in immunotherapy posttransplant in allograft recipients is based largely on the minimal residual disease model. If tumor cells found within grafts are inherently more metastatic, their contribution to relapse posttransplant may be out of proportion to their numbers. This would reinforce the need to purge

autografts and, potentially, combine purging with posttransplant immunotherapy using “ex vivo educated” autologous or allogeneic cytotoxic cells. Finally, processing laboratories are now expected to operate according to good manufacturing practices (GMP), and good tissue practices (GTP) are on the horizon. This involves rigorous documentation, validation of procedures, competency and proficiency testing, filing of applications with the US Food and Drug Administration (FDA), extensive quality assurance and quality control, etc, all at added cost. The field of cellular and gene therapy is also under particularly close scrutiny at the present time. The challenge will be to develop these technologies in a scientific, cost-effective manner that recognizes their experimental nature, poses no unnecessary risk to patients, and meets regulatory expectations.

## **AUTOLOGOUS GRAFT MANIPULATION**

### **Introduction**

The use of autologous grafts was originally proposed as the potentially perfect solution to finding a source of hematopoietic progenitor cells for patients who lacked an HLA-matched sibling donor. The proponents of this approach cited the universal availability of these cells and removal of the barriers of graft rejection and graft-vs.-host disease that had plagued allogeneic transplantation.

As is true for many developments in medicine, however, these advantages were achieved at a cost, in that the use of autologous grafts brought its own particular set of issues and problems. Although access to transplantation was extended dramatically, there were still certain patients from whom autologous cells could not be collected, because of prior pelvic irradiation, necrosis, or metastatic disease. A few of these individuals can now be harvested using apheresis techniques, but the quality of these harvests may be less than optimal.

### **Graft Quality**

In autologous recipients, engraftment problems shifted from graft rejection, seen in allogeneic recipients, to failure to engraft. Autologous recipients who received apparently adequate numbers of nucleated marrow cells showed either complete failure to engraft or a small engraftment that was not sustained. This has been attributed again to the quality of harvests obtained from autologous donors. These patients have often received extensive therapy for their disease, using agents that are myelosuppressive. The traditional measure of an adequate marrow graft, namely nucleated cells infused per kilogram body weight, did not take into account the functional capacity of these cells or their composition. As our understanding of these parameters has increased, it is clear that engraftment is a complex process,

involving multiple cells of different lineages. The discovery of the CD34 antigen provided an additional measure of adequacy, but also illustrated that patients may receive large doses of these cells and still not achieve stable engraftment. This has prompted studies into the identity of so-called accessory cell populations that may facilitate and sustain engraftment, eg, stromal cells. The theory is that in autologous recipients who fail to engraft, these populations may be damaged or eradicated by prior therapy, and insufficient numbers are infused in the graft to compensate. This concern was reinforced when transplants were performed using CD34-selected progenitor cells, since it was not clear whether accessory cells would be removed by the selection procedure. To date, the engraftment times of selected and non-selected grafts are generally similar, although an extensive survey in comparable groups of patients has yet to be reported.

### **Tumor Contamination**

Whereas hematopoietic progenitor cell quantity and quality were, and remain, an issue in autologous transplants, the major area for controversy was the potential for reinfusing tumor cells with autologous grafts. It was feared that many autologous harvests would contain occult viable tumor, and that this could act as a source for relapse of disease posttransplant. Camps arose on both sides of the debate, making plausible arguments for and against *ex vivo* purging of tumor cells from autografts. Opponents of purging predominantly argued that the number of cells likely to be reinfused in a graft that was free of tumor by conventional histology was clinically irrelevant, compared with the number of cells in the recipient that may escape high-dose therapy. They believed that the time, effort, and cost devoted to developing purging technologies would not result in any measurable clinical benefit to the patient. In addition, they believed that *ex vivo* manipulation of the cells for purging could pose a significant risk, in both the potential to contaminate the graft and the ability of the cells to engraft the recipient. Purging proponents countered that it did not make sense to infuse tumor knowingly into a patient if there was an effective means of removing it from the graft. They believed that this could even be considered unethical. Unfortunately, this debate raged in the absence of almost any hard data to support either side.

The generation of information to assess the value of *ex vivo* purging has been a long and tortuous task, one that is still not complete. It has revealed the complexity of the problem and made us return to the basics of how we tackle such issues. It was clear relatively early on in the debate that there were methods available for removing tumor cells from complex cell mixtures. However, the model systems and quantitation methods used were often less than rigorous. Laboratory model systems were often chosen to optimize the chances of success, rather than reflect clinical reality. For example, cultured cells expressing large amounts of the tumor-

associated target molecule were seeded into blood or marrow substitutes at levels that were well beyond those that would normally be considered for purging. Quantitation methods were usually not validated, and the sensitivities of the techniques were not cited. As a result, investigators banded around log-depletion values for specific procedures that were difficult to compare and whose clinical relevance was questionable.

### **Tumor Detection Technology**

This confused situation was to be partially resolved by the involvement of experts in tumor detection.<sup>1</sup> Over the last few years, we have seen a renewed emphasis on the development of techniques to detect tumor for diagnosis and staging. Gradually, a consensus has been reached on which reagents should be used and how to score positive events. These methods have also been applied to validation of purging methods and have established new expectations as to how to monitor tumor involvement. Currently, immunocytochemical techniques predominate. In the right hands, these have reported sensitivities of as high as 1 tumor cell in >100,000 cells. Automation of readout also allows very large numbers of cells to be scanned, resulting in more representative results. Molecular approaches promise to extend the range of sensitivity, once quantitation becomes more reliable, and the incidence of false positives and false negatives can be satisfactorily reduced.

The availability of reliable, quantitative, and sensitive tumor detection assays was an essential prerequisite if it was ever to be possible to determine the efficacy of any purging method, and if the clinical value of purging was to be determined. In the interim, there was an ongoing debate with the regulatory agencies on how to design purging trials. Traditional randomized designs would have required very large numbers of patients on the purge and no-purge arms, with extensive follow-up, to achieve statistical significance. It became clear that this would be prohibitively expensive and time-consuming and may not even be possible for some diseases.

### **The Purging Debate**

Data from gene-marking studies, in which marked tumor cells were infused in autologous grafts and detected at sites of relapse, supported the role of purging. Laboratory data demonstrated that purging techniques could remove tumor to the detection limits of relatively sensitive detection assays. Clinical data were also reported showing an advantage to lymphoma patients who received effectively vs. noneffectively purged grafts. Taken together, this information may have provided a sufficient degree of assurance to the regulatory agencies to allow them to abandon the traditional requirement for a randomized study design. European trials on

lymphoma purging are ongoing, however, and preliminary data suggest a marginal, non-statistically significant benefit in the purging arm.

In terms of purging methodology, technologies have generally moved from the use of chemotherapeutic agents and antibodies and complement toward physical separation techniques employing combined approaches. Some of this has been encouraged by pending regulatory requirements that discourage the use of animal sera, etc. Molecular methods are already in pilot studies and will probably become the method of choice for diseases in which there is a suitable molecular target. For the remainder, it seems likely that there will be a move toward including a positive selection step, in which tumor is depleted by default during the enrichment of CD34<sup>+</sup> hematopoietic progenitors. The present methods for CD34 selection are inadequate to provide the very high purities required to achieve substantial tumor depletion. Usually, positive selection results in 1 to 2.5 logs of tumor removal. This can be improved by combining selection with a tumor-directed depletion technique. Immunomagnetic methods currently predominate for positive selection, and FDA-approved devices are now available. This technology can be modified to include a simultaneous or follow-up tumor-purging step, resulting in grafts that are essentially tumor-free by immunocytochemical detection techniques or polymerase chain reaction.

### **Bone Marrow vs. Peripheral Blood**

A challenge to the graft manipulation laboratory has been the move away from bone marrow and toward peripheral blood progenitor cells (PBPCs) collected by apheresis. It is clear that this change is permanent and brings significant advantages in terms of speed of engraftment, decreased hospital stay, etc. For autologous donors, the practice has been to mobilize PBPCs by a combination of chemotherapy and recombinant growth factors. This approach is less predictable than use of growth factors alone, and certain patients may fail to mobilize at all. For poor mobilizers, the laboratory is faced with having to process multiple apheresis products collected over several days. If these are to be purged, the decision has to be made whether to pool the collections to save cost. Initially, it was believed that PBPC collections would contain fewer tumor cells than marrow harvests, and as a proportion of the cells collected this may be true in many cases. This benefit is counteracted, however, by the fact that many more cells are collected, particularly from autologous donors, to attain the target CD34<sup>+</sup> cell dose, and that the mobilization regimens may also drive tumor cells into the peripheral circulation. The laboratory is then faced with the decision as to how such collections should be manipulated to provide an optimal graft at manageable cost. Once again, the availability of sensitive and quantitative assays for tumor detection is critical for making these types of decisions.

### **Progenitor Cell Assays**

A missing component in autologous graft evaluation, however, is still a reliable measure of engraftment potential. The move away from nucleated cell dose to CD34<sup>+</sup> cells has helped, especially now that some of the variability in the assay system has been resolved. Every center, however, has cases in which CD34 doses did not predict engraftment kinetics, and the assay provides no measure of the functional activity of the cells. In addition, it is clear that the CD34<sup>+</sup> population does not represent the true pluripotent stem cell, which some believe may be CD34<sup>-</sup>. For routine clinical patient management, it may be irrelevant to try to measure true stem cell numbers, when what is sought is an *in vitro* marker for engraftment time, but even then, CD34<sup>+</sup> cells provide only a partial answer. *In vitro* colony-forming assays do provide an indication of functional activity of progenitor cells; however, they have prolonged read-out times, which makes them of limited value in many cases. Routine colony assays measure lineage-committed progenitors, which are not an absolute prerequisite for engraftment. We are, therefore, still somewhat handicapped in determining how graft manipulation and storage may potentially compromise normal hematopoietic potential. When dealing with autologous grafts from pretreated donors, this information could be of tremendous value.

### **Cryopreservation**

A much-neglected feature that distinguishes autograft manipulation from allogeneic graft processing is cryopreservation. It is standard practice to freeze autologous grafts after processing so that they can be stored while the patient receives high-dose conditioning therapy. The standard technique is to suspend the cells in a tissue culture medium containing 10% vol/vol dimethylsulfoxide (DMSO) and to reduce the temperature in a controlled manner with eutectic point compensation, using a programmable freezing device. For storage, the cells are transferred to liquid nitrogen, usually in the vapor phase to minimize the potential for cross-contamination by infectious organisms. The only real development in recent years in this technology has been to use a mixture of 5% DMSO and hydroxyethyl starch as the freezing medium and to transfer the cells directly to a -80°C freezer for storage. It is evident that both techniques adequately preserve the hematopoietic potential of cells, but it is not clear whether they are truly optimal. There have been isolated reports that cryopreservation may have the potential to destroy leukemic cells selectively, thereby providing a form of purging. We have also tended to neglect quality measurements of the thawed products, relying on simple dye exclusion assays to assess the viability of products coming out of storage. This has been in part because infusions are usually performed at some

distance from the laboratory, and thawed cells may sit for some time at ambient temperature in the presence of cryoprotectants before they can be tested. We are likely to see encouragement from regulatory agencies to improve this area and to generate more comprehensive data on the effects of long-term storage under varying conditions, thawing, holding, and transporting cellular products before infusion.

### **Minimal Residual Disease and Immunotherapy**

It is true to say that some of the heat has gone out of the purging debate, as improved tumor detection assays have provided a framework within which we should be able to reach a conclusion on the value of tumor purging for certain diseases. This has been aided by the finding, in allogeneic graft recipients, that minimal residual disease can be effectively treated by immunotherapy. This stemmed from observations of decreased relapse of chronic myeloid leukemia in patients who developed graft-vs.-host disease, progressed to the infusion of donor leukocytes posttransplant both therapeutically and prophylactically, and has now spawned a major effort to grow tumor-directed immune effector cells. These developments have supported the concept that immunotherapy is most effective in the context of minimal residual disease. In the case of autologous transplant recipients, this concept would be favored by reducing tumor burden in the graft by purging. One could also argue that these particular tumor cells may be potentially more tumorigenic, since they have already metastasized to the marrow, and gene-marking experiments have shown that they can home to sites of disease relapse. Their potential to restore disease, therefore, may be disproportionate to their numbers, compared with tumor cells found in association with the primary. It remains to be seen whether effective immunotherapy can be developed for autologous graft recipients by using targeted autologous effectors or modified allogeneic cells.

### **Economic Concerns**

In the United States, two developments have had a tremendous impact on how transplantation is performed. The first is managed health care. Managed care has caused us to try to reduce costs and introduce savings at every stage of the procedure, including the laboratory. Third-party payers are unwilling to underwrite the cost of anything they perceive as research, and this, for the majority, includes autologous tumor purging. In addition, the cost of the entire transplant may be capitated, making it possible to include extensive manipulation if deemed necessary, but only if the cost can be recovered within the cap or covered through other means. The debate as to when a procedure transitions from research to

standard of care within rapidly moving fields, such as transplantation and cellular therapy, will continue for the foreseeable future.

## **Regulation**

The second development is impending regulation of the field of cellular and gene therapy. The FDA has indicated its intent to regulate this area for several years<sup>2,3</sup> and has published a number of proposed approaches. Although there have been changes, there are a number of common themes. The first is that cell processing should be performed under current good manufacturing practices (cGMP).<sup>4</sup> These are a series of regulations initially developed for manufacturers of pharmaceuticals and more recently extended into the blood-banking industry. They cover facilities, training, documentation, quality assurance and controls, labeling, etc, but essentially provide a method for control of the manufacturing process and traceability of the manufactured component from the start to its eventual disposition.

Implementation of cGMP, particularly in an academic environment unused to considering itself to be a product manufacturer, has caused some consternation. Much of this has focused on the design of the facility. Institutions have been concerned that they must build expensive clean rooms to process cells for transplantation. This has not, at this time, been a requirement of cGMP as applied to this area, although some organizations have anticipated it as a future requirement, particularly for the manufacture of extensively manipulated or genetically modified products. At this stage, the emphasis of the agency has been more on ensuring that there are systems in place for thorough documentation, validation of procedures, quality assurance/quality control, tracking of reagents and materials used in manufacturing, etc. It has been recognized that hematopoietic progenitor cell (HPC) processing and manipulation does not fit the traditional drug manufacturing format and that this fit is liable to become worse as newer cellular therapies are developed. The FDA, therefore, has proposed a new system to be named current good tissue practices (cGTP) that would be specifically designed for the field. The exact contents of cGTP were not available at the time of publication.

In addition to cGMP, the FDA has indicated that it will impose regulations that are based on the perceived risks posed by the procedure to the donor and the recipient. Included among factors that are considered when assessing risk are the potential for transmission of infectious agents,<sup>3</sup> how closely related the donor and recipient are, and the degree to which cells will be manipulated *ex vivo*. The regulations cover PBPCs and umbilical cord blood cells, but not bone marrow. Under the proposal, autologous cells would be less stringently regulated than those from allogeneic sources, and investigational new drug (IND) applications or investigational device exemptions (IDEs) would be required only if the product



was extensively manipulated *ex vivo*. Extensive manipulation would include procedures such as genetic modification, *ex vivo* culture, and purging/selection with nonapproved reagents or devices. These regulations have yet to be finalized, and investigators are encouraged to contact the Center for Biological Evaluation and Research to determine whether an IND or IDE is required for a particular procedure.

### **Commercial Concerns**

This raises another difficult issue, that of access to new technologies. As regulation of this area has increased, it has become almost impossible for academic institutions to shoulder the cost of bringing a new therapy from the laboratory into early clinical trials. Stringent testing requirements and production controls for biologicals mean that most centers will look to a commercial organization to assist with the process. Funding from the biotechnology industry has made possible some of the procedures that are now in use in the area of cellular therapies. At present, however, this is still a relatively small market, and we have seen many companies fall by the wayside or be driven from business by legal action. This makes it increasingly difficult to pilot any new form of therapy that is not of direct interest to a company or that requires products from competing companies. The diminishing number of commercial players also restricts the availability of technologies, and those that survive may not be optimal for use in every application. There is no doubt that the problem has been exacerbated by regulatory requirements designed primarily to ensure patient safety. The struggle will be to recognize that there will always be a risk-benefit ratio for experimental therapies, and attempts to eliminate all risk will ultimately make it virtually impossible for investigators to develop procedures that are not of direct interest to commercial entities. In return, the investigator has an obligation to ensure that every reasonable step is taken to protect the patient from unnecessary risk.

### **Representation**

Recent incidents in gene therapy in the United States have alarmed the public and regulatory agencies and have resulted in imposition of more extensive testing and reporting requirements. The rationale, scientific value, and potential for improving safety that can be achieved by these can be debated; however, it is likely that cellular therapies will also be viewed with increasing scrutiny. As professionals, we need to support any effort that truly will ensure that patients are offered safe and potentially effective therapies; however, we also must recognize that these procedures inherently carry an associated risk by the very fact that they are experimental. It is the responsibility of the field and its professional organizations to

represent the potential risks and benefits in an accurate manner and to assist in developing regulations that protect the patient appropriately. This must, however, be achieved in a manner that does not fossilize the potential for a therapy to reach its full potential.

One way that this has been addressed in the transplant community has been by the development and publication of *Standards for Hematopoietic Progenitor Cell Collection, Processing and Transplantation* by the Foundation for the Accreditation of Hematopoietic Cell Therapy (FAHCT).<sup>5</sup> These standards cover all aspects of therapeutic HPC use and are implemented through a voluntary inspection and accreditation process. Similar standards are being implemented in Europe through a joint program between the International Society for Hematotherapy and Graft Engineering and the European Group for Blood and Marrow Transplantation.<sup>6</sup> Organizations such as these have an invaluable role in interacting with regulatory agencies to develop laws appropriate for therapies that are in rapid evolution. Failure to provide such input will probably result in implementation of draconian regulations that may be questionable both scientifically and in their potential to provide added safety to the patient. In addition, the added cost of complying with such requirements is likely to be beyond the reach of most academic organizations, which have historically been the cradle for the most important developments in medicine.

## CONCLUSIONS

Autologous graft manipulation presents a number of unique challenges to the cell processing laboratory. These include the quality of the HPC product, the change in source from marrow to mobilized peripheral blood, and the use of cryopreservation. The predominant debate on whether grafts should be purged has somewhat abated as sensitive and accurate techniques have evolved for tracking tumor incidence in both the graft and the patient. Purging can be seen as one more tool to achieve minimal residual disease posttransplant, with the hope that immunotherapy may then provide an additional means for cure. The challenge will be to develop these new strategies in an increasingly regulated environment where commercial considerations may ultimately determine whether a new approach ever leaves the laboratory bench.

## REFERENCES

1. Meeting report: Second International Meeting on Minimal Residual Cancer. *Cytotherapy* 1:53-94, 1999.
2. US Food and Drug Administration. A proposed approach to the regulation of cellular and tissue-based products. *Fed Reg* 62:9721, 1997.

3. US Food and Drug Administration. *Guidance for Human Somatic Cell and Gene Therapy, Guidance for Industry, Center for Biologics Evaluation and Research*. March 1998.
4. Current Good Manufacturing Practice for Blood and Blood Components. *Code of Federal Regulations* Title 21, Part 606, 2000.
5. Foundation for the Accreditation of Hematopoietic Cell Therapy. *Standards for Hematopoietic Progenitor Cell Collection, Processing and Transplantation*. North America, 1996.
6. *Standards for Blood and Marrow Progenitor Cell Collection, Processing and Transplantation*. Joint Accreditation Committee of ISHAGE Europe and EBMT. 1998.

# Clinical and Technical Considerations to Optimize Mobilization and Collection of Peripheral Blood Stem Cells

*D.L. Livingston, K.A. Dicke*

*Nexell Therapeutics (D.L.L.), Irvine, California;  
Arlington Cancer Center (K.A.D.), Arlington, Texas*

## ABSTRACT

Between February 1996 and March 2000, using chemotherapy and granulocyte colony-stimulating factor (G-CSF) for mobilization, we performed 302 peripheral stem cell collections (PSCCs) on 147 solid tumor patients and 83 PSCCs on 30 hematologic patients. Our goal was to collect 2 transplants of  $4\text{--}5 \times 10^6$  CD34<sup>+</sup> cells/kg per transplant. Based on our experience harvesting bone marrow, we collected cells from patients before therapy with fludarabine, BCNU, melphalan, or mitomycin and either before or at least 1 year after radiation therapy. We mobilized patients using standard induction chemotherapy appropriate for their disease (rather than intensive-dose cyclophosphamide), followed by 5  $\mu\text{g}/\text{kg}$  G-CSF daily throughout apheresis.

Standard-volume procedures, 10–14 L, were carried out on either a Fenwal CS3000 (Baxter) or Cobe Spectra (Gambro BCT). Large-volume leukapheresis (LVL), 15–20 L, was performed using the Spectra because it is capable of processing 100–120 mL/min and accommodates >150 mL product volume. LVL produced superior results in solid tumor patients.

<i>Procedure</i>	<i>n</i>	<i>Liters Processed</i>	<i>Blood Volumes Processed</i>	<i>CD34<sup>+</sup> Cells /<math>\mu\text{L}</math> Blood</i>	<i>Total CD34<sup>+</sup> Cells <math>\times 10^6/\text{kg}</math></i>
Large volume	222	19 $\pm$ 1	4.7 $\pm$ 0.6	48 $\pm$ 39	4.0 $\pm$ 3.1
Standard volume	80	11 $\pm$ 1	2.7 $\pm$ 0.4	40 $\pm$ 35	2.4 $\pm$ 2.2
<i>P</i>			<.001	.392	.023

The impact in hematologic patients was not statistically significant; however, analysis of a subset of patients with >20 CD34<sup>+</sup> cells/ $\mu\text{L}$  in the blood did reveal an advantage for LVL.

<i>Procedure</i>	<i>n</i>	<i>Liters Processed</i>	<i>Blood Volumes Processed</i>	<i>CD34<sup>+</sup> Cells /<math>\mu</math>L Blood</i>	<i>Total CD34<sup>+</sup> Cells <math>\times 10^6</math>/kg</i>
Large volume	25	20 $\pm$ 1	4.1 $\pm$ 0.8	73 $\pm$ 51	6.0 $\pm$ 3.4
Standard volume	15	12 $\pm$ 1	2.3 $\pm$ 0.3	60 $\pm$ 32	2.7 $\pm$ 1.1
<i>P</i>			<.001	.460	.007

In 28 consecutive patients, we identified additional mobilization of CD34<sup>+</sup> cells at between 15 and 20 L of processed blood.

	<i>Patient's Circulation</i>	<i>Apheresis Product, L</i>			
		<i>5</i>	<i>10</i>	<i>15</i>	<i>20</i>
Mean number of CD34 <sup>+</sup> cells, $\times 10^6$	81	34	98	92	193

Patient management during LVL included a blood warmer and calcium gluconate, plus potassium chloride and magnesium sulfate spiked into the return line as needed. Only 1 of 287 patients undergoing LVL experienced side effects requiring medical intervention. LVL can be performed safely and result in the collection of 3–4  $\times 10^6$  CD34<sup>+</sup> cells/kg in a single procedure.

## INTRODUCTION

Peripheral blood, after mobilization with chemotherapy and/or growth factors, has become the primary source of CD34<sup>+</sup> progenitor cells for autologous transplant support following intensive-dose chemotherapy.<sup>1</sup> Although a minimal threshold has not been established, it has been suggested that 2–5  $\times 10^6$  CD34<sup>+</sup> cells/kg will provide rapid and sustained multilineage engraftment.<sup>2,3</sup> The number of apheresis procedures to obtain adequate CD34<sup>+</sup> cells for transplant is influenced by the patient's disease state, previous treatment history, mobilization regimen, and timing and efficiency of collection.<sup>4,5</sup> The level of circulating CD34<sup>+</sup> cells can predict the progenitor content in the final apheresis product,<sup>6,7</sup> thereby providing a measurable parameter to identify the best time to commence collection. Large-volume leukapheresis, defined as processing 3 or more blood volumes, can increase the efficiency of collection, resulting in fewer procedures and more patients achieving their threshold number of CD34<sup>+</sup> cells for transplant.<sup>8,9</sup> Performing fewer leukaphereses not only conserves tangible resources but also reduces the risks to the patient during collection and at transplant through the infusion of smaller volumes of cells and less dimethylsulfoxide.

## PATIENTS AND METHODS

Using a 10- to 14-liter standard-volume leukapheresis (SVL) or LVL of 15–20 L, 385 leukapheresis procedures were performed on 177 consecutive patients (Table 1).

**Table 1.** Leukapheresis Procedures

	<i>Number of Patients</i>	<i>Number of Procedures</i>
Solid tumor patients	147	302
Breast cancer	140	
Ovarian cancer	7	
10–14 L processed		80
15–20 L processed		222
Hematologic patients	30	83
Non-Hodgkin's lymphoma	17	
Multiple myeloma	11	
Chronic lymphocytic leukemia	2	
10–14 L processed		18
15–20 L processed		65
Total	177	385

Patients either had no history of radiation therapy or had completed radiation therapy more than 12 months before. Patients had no detectable brain metastases at the time of collection and no history of chemotherapy involving BCNU, mitomycin, melphalan, or fludarabine. All patients met the eligibility criteria for their disease-specific high-dose chemotherapy and transplant protocol and gave

**Table 2.** Mobilization Chemotherapy

<i>Indication and Regimen</i>	<i>Total Chemotherapy Drug Doses</i>
Breast cancer	
FAC	500 mg/m <sup>2</sup> fluorouracil, 50 mg/m <sup>2</sup> adriamycin, 500 mg/m <sup>2</sup> cyclophosphamide
CAVe	500 mg/m <sup>2</sup> cyclophosphamide, 50 mg/m <sup>2</sup> adriamycin, 80 mg/m <sup>2</sup> VP-16
CAT	500 mg/m <sup>2</sup> cyclophosphamide, 50 mg/m <sup>2</sup> adriamycin, 175 mg/m <sup>2</sup> paclitaxel
Ovarian cancer	
CTX/CDDP	2 g/m <sup>2</sup> cyclophosphamide, 90 mg/m <sup>2</sup> cisplatin
Lymphoma	
CHOP	800 mg/m <sup>2</sup> cyclophosphamide, 50 mg/m <sup>2</sup> adriamycin, 2 mg vincristine
DHAP	160 mg dexamethasone, 300 mg/m <sup>2</sup> cytosine arabinoside, 90 mg/m <sup>2</sup> cisplatin
Multiple myeloma	
CVAD	1 g/m <sup>2</sup> cyclophosphamide, 1.6 mg vincristine, 32 mg/m <sup>2</sup> adriamycin

**Table 3.** Timing of Apheresis From Start of Mobilization Chemotherapy\*

<i>Regimen</i>	<i>Number of Days for Apheresis</i>	<i>Median CD34<sup>+</sup> Cells ×10<sup>6</sup>/Procedure (Range)</i>
FAC	12–16	110 (62–461)
CAVe	12–16	319 (162–738)
CAT	12–15	124 (56–1054)
CTX/CDDP	13–17	100 (55–553)
CHOP	15–18	319 (162–738)
DHAP	15–18	243 (171–314)
CVAD	14–17	109 (68–521)

\*For definitions of regimens, see Table 2.

written informed consent for treatment, including the mobilization and collection of their peripheral blood stem cells (PBSCs).

Mobilization was accomplished using standard-dose induction chemotherapy appropriate for the diagnosis (Table 2) followed by G-CSF (Neupogen; Amgen, Thousand Oaks, CA) 5  $\mu$ g/kg subcutaneously every day beginning 48 hours after chemotherapy and continuing until apheresis was completed.

Mobilization patterns for a specific disease and treatment regimen were so consistent, we were able to identify “windows of opportunity” for leukapheresis that were invaluable for planning the start of chemotherapy and scheduling instrument time (Table 3).

Leukapheresis procedures were performed on an outpatient basis using the Fenwal CS3000 (Baxter) or Cobe Spectra (BCT Gambro) instruments. The ratio of acid-citrate-dextrose (ACD) to blood was held constant throughout the procedure at 1:18 without any additional systemic anticoagulation, eg, heparin. Performance differences between the 2 instruments were related to the maximum processing speed, 85 mL/min for the Fenwal and 120 mL/min for the Cobe. Large-volume procedures, 18–20 L, took 2.8 hours on the Cobe compared with 3.9 hours on the Fenwal.

Diuretics and systemic anticoagulants were stopped 48–72 hours before the first anticipated procedure. Complete blood counts were performed on a daily basis with transfusion support to maintain hemoglobin >9.5 g/dL and platelets >40,000/ $\mu$ L. Serum electrolytes were monitored daily throughout apheresis. Intravenous electrolytes, 30–60 mEq KCl and 14–28 mEq MgSO<sub>4</sub>, were given during the leukapheresis through the return line to maintain the levels of potassium and magnesium above 3.0 and 1.5 mEq/L, respectively. Serum calcium was maintained at 10.0 mEq/L or higher with continuous intravenous calcium gluconate, 9.6 mEq, through the return line. The return line was run through a blood warmer set at 37°C. Breakthrough symptoms, consisting mainly of peripheral tingling, numbness, and chills, were handled with oral calcium supplements. Persistent or worsening symptoms required slower and/or shortened procedures.

PBSCs were identified in the blood and apheresis products using flow cytometry following the Milan-Mulhouse protocol. Briefly, samples were labeled with 20  $\mu\text{L}$  of an anti-CD34 phycoerythrin-conjugated monoclonal antibody (HPCA-2; Becton Dickinson, Mountain View, CA). Red cells were lysed, samples were washed once, and  $7.5 \times 10^4$  cells were acquired on a FACSort flow cytometer (Becton Dickinson). Analysis of CD34 expression vs. side scatter was performed using Cellquest and Paint-a-Gate software. Events with low side scatter and CD34 fluorescence in the third to fourth decade were considered positive.

## RESULTS

As illustrated in Table 4, there was no difference in the number of peripheral CD34<sup>+</sup> cells in either the solid tumor or hematologic patients undergoing SVL vs. LVL. The number of blood volumes processed was increased from approximately 3 to 5 for the predominantly female solid tumor patients and from 2 to 4 for the predominantly male hematologic patients. This resulted in a significantly higher level of CD34<sup>+</sup> progenitors in the final apheresis product of the solid tumor patients,  $2.4 \times 10^6$  vs.  $4.0 \times 10^6$  CD34<sup>+</sup> cells/kg. Patients with hematologic malignancies also had somewhat higher numbers of CD34<sup>+</sup> cells in the final product; however, the difference did not reach statistical significance, possibly because of the nature of their disease and the relatively small number of patients in the SVL group.

Considering the difficulty inherent in mobilizing hematologic patients, we examined the outcome for patients who achieved  $>20$  CD34<sup>+</sup> cells/ $\mu\text{L}$  peripheral blood and were considered to be good mobilizers. Increasing the number of blood volumes processed significantly improved the CD34<sup>+</sup> content of the final apheresis product from a mean of  $2.7 \times 10^6$  to  $6.0 \times 10^6$  CD34<sup>+</sup> cells/kg (Table 5), thereby permitting the collection of enough CD34<sup>+</sup> progenitors for multiple transplants from a single apheresis.

**Table 4.** Impact of Large-Volume Apheresis: All Procedures

<i>Procedure</i>	<i>n</i>	<i>Liters Processed</i>	<i>Blood Volumes Processed</i>	<i>CD34<sup>+</sup> Cells /<math>\mu\text{L}</math> Blood</i>	<i>Total CD34<sup>+</sup> Cells <math>\times 10^6/\text{kg}</math></i>
<b>Solid tumor patients</b>					
Standard volume	80	11 $\pm$ 1	2.7 $\pm$ 0.4	40 $\pm$ 35	2.4 $\pm$ 2.2
Large volume	222	19 $\pm$ 1	4.7 $\pm$ 0.6	48 $\pm$ 39	4.0 $\pm$ 3.1
<i>P</i>			<.001	.392	.023
<b>Hematologic patients</b>					
Standard volume	18	12 $\pm$ 1	2.2 $\pm$ 0.3	51 $\pm$ 31	2.4 $\pm$ 1.1
Large volume	65	20 $\pm$ 1	3.9 $\pm$ 0.6	35 $\pm$ 31	3.0 $\pm$ 2.4
<i>P</i>		<.001	.203	.359	



**Table 5.** Impact of Large-Volume Apheresis on Hematologic Patients

Procedure	n	>20 CD34 <sup>+</sup> cells/ $\mu$ L Blood			
		Liters Processed	Blood Volumes Processed	CD34 <sup>+</sup> Cells/ $\mu$ L Blood	Total CD34 <sup>+</sup> Cells $\times 10^6$ /kg
Standard volume	15	12 $\pm$ 1	2.3 $\pm$ 0.3	60 $\pm$ 32	2.7 $\pm$ 1.1
Large volume	25	20 $\pm$ 1	4.1 $\pm$ 0.8	73 $\pm$ 51	6.0 $\pm$ 3.4
P				0.460	0.007

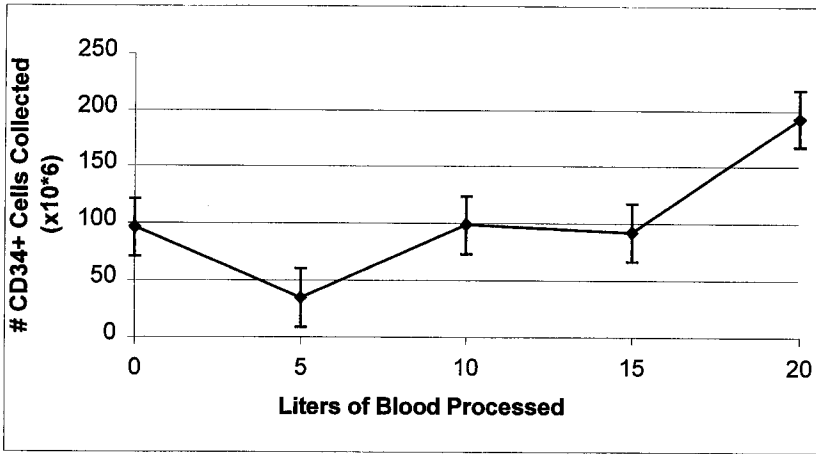
The question remains if there is a benefit to applying this approach in poor-mobilizing patients. A substantial number of procedures (Table 6) in both groups of patients were performed on individuals who mobilized considerably less than 20 CD34<sup>+</sup> cells/ $\mu$ L blood. In spite of the less-than-optimal number of circulating CD34<sup>+</sup> cells, it was possible to collect  $1.1 \times 10^6$  CD34<sup>+</sup> cells/kg per procedure, thereby making it possible to harvest a transplant of  $>3 \times 10^6$  CD34<sup>+</sup> cells/kg in 3 procedures. Solid tumor patients considered to be poor mobilizers had a mean of  $0.6 \times 10^6$  CD34<sup>+</sup> cells/kg per procedure with standard-volume apheresis, a value significantly lower than  $1.1 \times 10^6$  CD34<sup>+</sup>/kg ( $P=.002$ ).

In an attempt to understand mobilization kinetics during LVL, we analyzed samples from the product bag of 28 consecutive patients at defined time points during the procedure (Figure 1). The mean total number of peripheral CD34<sup>+</sup> cells was just under  $100 \times 10^6$  before starting the collection. After processing 10 L of blood, virtually the entire circulating progenitor population was identified in the product bag, with no further accumulation between 10 and 15 L of total processing volume. Continued collection past 15 L produced an additional mobilization of progenitors, permitting the harvest of more CD34<sup>+</sup> cells than was originally demonstrated in the patient's circulation.<sup>4,10,11</sup>

Regardless of the number of blood volumes processed, commencement of apheresis is ideally based on the level of circulating CD34<sup>+</sup> progenitors.<sup>6,7</sup> However, many facilities must rely on the white blood cell count (WBC) as a surrogate signal and begin collecting the day (or the day after) the WBC reaches 1000 or 10,000/ $\mu$ L. We retrospectively examined each patient's first harvest as it related to the day of chemotherapy, the number of circulating CD34<sup>+</sup> cells/ $\mu$ L, and their WBC (Table 7).

**Table 6.** Impact of Large-Volume Apheresis on Poor-Mobilizing Patients

Patient	n	<20 CD34 <sup>+</sup> cells/ $\mu$ L Blood			
		Liters Processed	Blood Volumes Processed	CD34 <sup>+</sup> Cells/ $\mu$ L Blood	Total CD34 <sup>+</sup> Cells $\times 10^6$ /kg
Hematologic	40	20 $\pm$ 1	3.8 $\pm$ 0.5	11 $\pm$ 4.0	1.1 $\pm$ 0.4
Solid tumor	86	19 $\pm$ 1	4.9 $\pm$ 0.5	10 $\pm$ 4.2	1.1 $\pm$ 0.5



**Figure 1.** Number of CD34<sup>+</sup> cells collected as a function of liters of blood processed.

Poor mobilizers,  $<20$  CD34<sup>+</sup>/ $\mu$ L blood, in both groups of patients typically took 2 weeks from the start of chemotherapy to begin apheresis and had WBCs substantially higher than 1000 or 10,000/ $\mu$ L on the first day of collection. A pattern of higher WBC at 2 weeks into therapy or recovery faster than 14 days was noted in solid tumor patients who had higher numbers of circulating progenitors. This was not as evident in the hematologic group, with no apparent difference between patients with  $<20$  and 20–50 CD34<sup>+</sup> cells/ $\mu$ L blood. Strong mobilizers among the hematologic patients still began collection on day 15, but their WBC was 2.5–3 times higher.

## DISCUSSION

Consistent, successful mobilization and collection of peripheral progenitor cells is dependent on a number of factors relating to the nature of the patient's disease, previous treatment history, priming regimen, timing of collection, and method and efficiency of leukapheresis within the context of patient safety.

Early identification of candidates for high-dose therapy and transplant facilitates progenitor collection before large-field radiotherapy and/or treatment with stem cell-toxic agents such as BCNU and fludarabine. Adequate mobilization is intimately linked to a balance between the amount of cytoreductive therapy used to reduce tumor load and risk of graft contamination and the amount of damage incurred by the hematopoietic stem cell compartment. At our facility, standard induction chemotherapy with growth factor support is not only effective for mobilizing adequate numbers of progenitors, it also avoids the morbidity so often

**Table 7.** White Blood Cell Count on Day 1 of Collection\*

	<i>CD34<sup>+</sup> Cells/<math>\mu</math>L Blood</i>			
	<i>&lt;20</i>	<i>20–50</i>	<i>51–100</i>	<i>&gt;100</i>
Solid tumor patients				
WBC, $\times 10^3/\mu\text{L}$	18.4 $\pm$ 8.4	22.6 $\pm$ 10.5	23.0 $\pm$ 10.7	32.0 $\pm$ 10.0
Day of chemotherapy	14	14	13	12
Hematologic patients				
WBC, $\times 10^3/\mu\text{L}$	17.1 $\pm$ 7.9	15.5 $\pm$ 6.0	No data	44.1 $\pm$ 5.8
Day of chemotherapy	15	15		15

\*WBC, white blood cell count.

associated with intensive regimens such as 4 g/m<sup>2</sup> cyclophosphamide. The impact may manifest not only in the quantity but also in the quality of stem cells harvested.

Collecting the maximum number of progenitors in the minimal number of procedures depends on the timing and efficiency of apheresis. Optimal timing of the first procedure is most effectively determined by measuring the circulating progenitor pool, and the efficiency of collection can be improved by taking advantage of the additional mobilization that occurs during large-volume apheresis. Knudsen et al.<sup>5</sup> identified a cut-off value of  $20 \times 10^3$  CD34<sup>+</sup> cells/mL, above which 81% of their standard 10-L leukapheresis procedures yielded at least  $10^6$  CD34<sup>+</sup> cells/kg. The question was raised whether harvesting should be performed when patients are below this value. By applying LVL at our facility, both solid tumor and hematologic patients who mobilized an average of only  $10\text{--}11 \times 10^3$  CD34<sup>+</sup> cells/ $\mu\text{L}$  had final products containing a mean of  $1.1 \times 10^6$  CD34<sup>+</sup> cells/kg. Hematologic patients capable of mobilizing more than  $20 \times 10^3$  CD34<sup>+</sup> cells/ $\mu\text{L}$  also benefited from large-volume procedures, as demonstrated by their final product, which contained an average of  $6 \times 10^6$  CD34<sup>+</sup> cells/kg after 20-L procedures compared with only  $2.7 \times 10^6$  CD34<sup>+</sup> cells/kg after 12-L collections. The benefit for solid tumor patients who are good mobilizers was not as clear:  $5.8 \times 10^6$  CD34<sup>+</sup> cells/kg after 19-L collections compared with  $4.3 \times 10^6$  CD34<sup>+</sup> cells/kg after 11-L collections.

It is important to define the total transplant dose needed and correlate this with the circulating stem cell pool to determine whether standard- or large-volume leukapheresis will achieve the desired end point. Large-volume apheresis should not be universally applied, because it is a procedure wrought with physiologic stresses during a time when the patient is trying to recover from the insult of chemotherapy. Patients are typically challenged with 1.5–2.0 L of fluid, half of which is anticoagulant, during a large-volume procedure, thereby requiring more rigorous management of electrolytes, hemoglobin, and platelets. Only 1 of the 177 patients in this report experienced side effects requiring physician intervention.

At Arlington Cancer Center, our goal is  $8\text{--}10 \times 10^6$  CD34<sup>+</sup> cells/kg, which historically took 4–5 standard-volume procedures to accomplish. With the introduction of large-volume apheresis, this goal can be achieved in only 2 procedures.

## REFERENCES

1. Korbaling M. Autologous and allogeneic blood stem cell transplantation: potential advantage of blood-over marrow-derived stem cell grafts. *Cancer Invest* 15:127–137, 1997.
2. Burt R. Clinical utility in maximizing CD34<sup>+</sup> cell count in stem cell grafts. *Stem Cells* 17:373–376, 1999.
3. Stewart DA, Guo D, Luider J, et al. Factors predicting engraftment of autologous blood stem cells: CD34<sup>+</sup> subsets inferior to the total cell dose. *Bone Marrow Transplant* 23:1237–1243, 1999.
4. Murea S, Goldschmidt H, Hahn U, et al. Successful collection and transplantation of peripheral blood stem cells in cancer patients using large-volume leukapheresis. *J Clin Apheresis* 11:185–194, 1996.
5. Knudson LM, Gaarsdal E, Jensen L, et al. Improved priming for mobilization of and optimal timing for harvest of peripheral blood stem cells. *J Hematother* 5:399–406, 1996.
6. Yu J, Leisenring W, Bensinger W, et al. The predictive value of white cell and of CD34<sup>+</sup> cell count in the peripheral blood for timing apheresis and maximizing yield. *Transfusion* 39:442–450, 1999.
7. Hollingsworth KL, Zimmerman TM, Karrison T, et al. The CD34<sup>+</sup> cell concentration in peripheral blood predicts CD34<sup>+</sup> cell yield in the leukapheresis product. *Cytotherapy* 1:141–146, 1999.
8. Passos-Coelho JL, Machado MA, Lucio P, et al. Large-volume leukapheresis may be more efficient than standard-volume leukapheresis for collection of peripheral blood progenitor cells. *J Hematother* 6:465–474, 1997.
9. Lefrere F, Makki J, Marolleau JP, et al. CD34<sup>+</sup> cells during leukapheresis procedures: relationship of volume processed and quantity of peripheral blood progenitor cells collected. *Transfusion* 40:493–494, 2000.
10. Smolowicz AG, Villman K, Berlin G, et al. Kinetics of peripheral blood stem cell harvests during a single apheresis. *Transfusion* 39:403–409, 1999.
11. Cull G, Ivey J, Chase P, et al. Collection and recruitment of CD34<sup>+</sup> cells during large-volume leukapheresis. *J Hematother* 6:309–314, 1997.

# **CHAPTER 2**

## **BREAST CANCER**



# **High-Dose Chemotherapy in Breast Cancer in Europe: EBMT Database and Ongoing Trials**

**Giovanni Rosti, Patrizia Ferrante, Felipe Prosper, John Crown,  
Claudio Dazzi, Maurizio Marangolo, on behalf of the European  
Group for Blood and Marrow Transplantation (EBMT)  
Solid Tumors Working Party Breast Cancer Registry**

*Department of Oncology and Hematology (G.R., P.F., C.D., M.M.), Ospedale Civile,  
Ravenna, Italy; Department of Medical Oncology and Hematology (F.P.), University of  
Valencia, Spain; Department of Oncology (J.C.), St. Vincent's Hospital, Dublin, Ireland*

## **ABSTRACT**

Every year in Europe, nearly 2500 patients receive high-dose chemotherapy for breast carcinoma. The majority of patients in recent years have been treated for high-risk operable breast disease. The European Group for Blood and Marrow Transplantation (EBMT) Breast Cancer Registry includes >6000 patients; from such a large database, some observations emerge.

The maximum age for an autotransplant for breast cancer has been increasing in the recent past, and the toxic death rate has declined to <1% for adjuvant patients. From the EBMT Registry analysis, patients with metastatic disease in complete remission at the time of graft experience a 3-year disease-free survival of nearly 30%, which compares favorably with standard chemotherapy data, even though we are still waiting for mature data from randomized trials in this cohort. High-risk operable breast cancer patients show a disease-free survival of ~50% at 4 years, and the same results also apply to the population with the worst prognosis (with >20 positive axillary nodes). Several ongoing phase 3 randomized trials are under way in Europe in metastatic as well as high-risk patients, and they will be producing data on >1500 patients a few years from now.

## **INTRODUCTION**

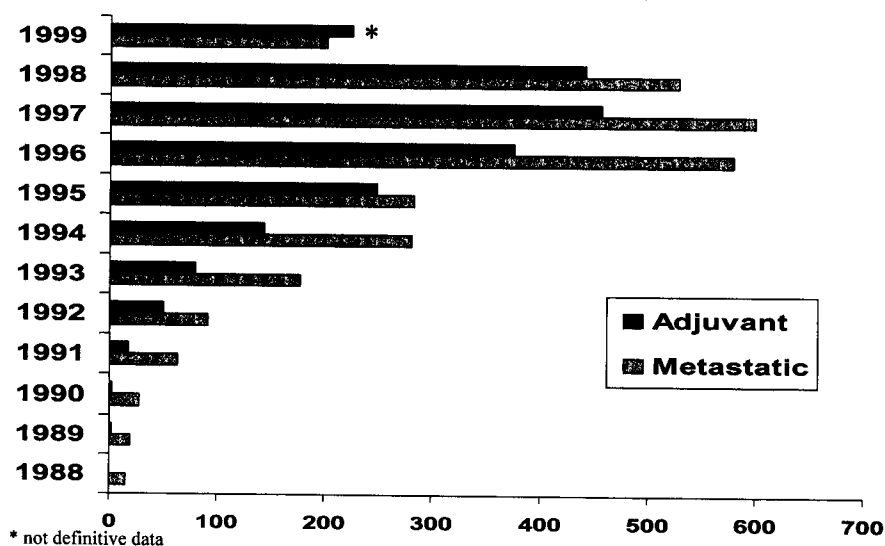
In the past few years, high-dose chemotherapy for breast carcinoma patients has been widely used in Europe. According to the most recent survey taken by the EBMT,<sup>1</sup> >2500 patients were treated in 1997, with a slight reduction in 1999 to the extent of ~10%–15%. The vast majority of patients received peripheral blood progenitor cells (PBPCs), and autologous bone marrow transplantation (autoBMT)

has been nearly universally abandoned as a source of hematopoietic stem cell rescue. The survey allows us just to make demographic observations; to evaluate results on big numbers, the only possible way is to look at registries. In 1984, the EBMT Solid Tumors Working Party set up a registry including patients from Europe as well as some non-European countries. By March 2000, 6572 breast cancer patients had been registered.<sup>2</sup> The aim of this article is to present the EBMT database as well as some results; a detailed analysis of the major ongoing randomized studies is also presented.

### THE EBMT DATABASE

As mentioned in the introduction, 6572 patients with breast carcinoma were registered by March 2000 (only 26 are male). The mean age at transplantation is  $45 \pm 8$  years; median, 45 years (range, 18–70 years). The majority of registered patients were treated for metastatic disease (2889 patients receiving 3482 grafts), whereas 2046 had high-dose adjuvant therapy (2289 grafts). Eight-hundred forty-six patients were treated for inflammatory breast cancer (1072 grafts). As shown in Figure 1, there was a constant increase in the number of patients treated with high-risk operable breast carcinoma.

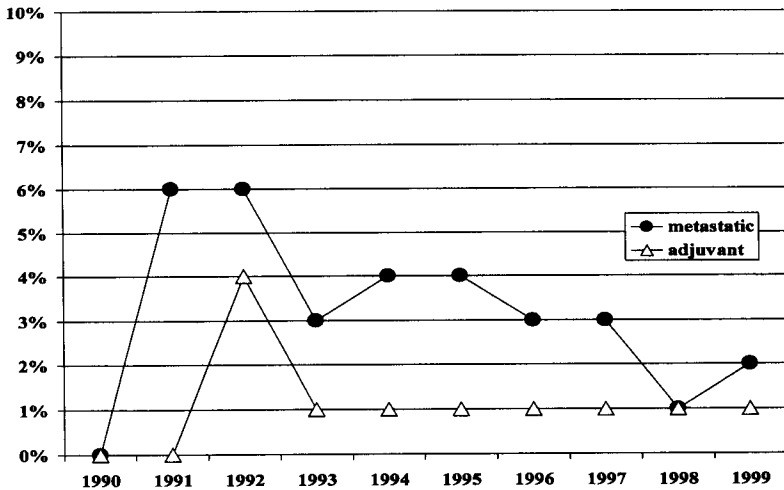
#### NUMBER OF PATIENTS PER YEAR: ADJUVANT vs. METASTATIC



**Figure 1.** Proportion of patients treated for metastatic or adjuvant disease in the European Group for Blood and Marrow Transplantation Registry database.



## TOXIC DEATHS: METASTATIC vs. ADJUVANT PATIENTS

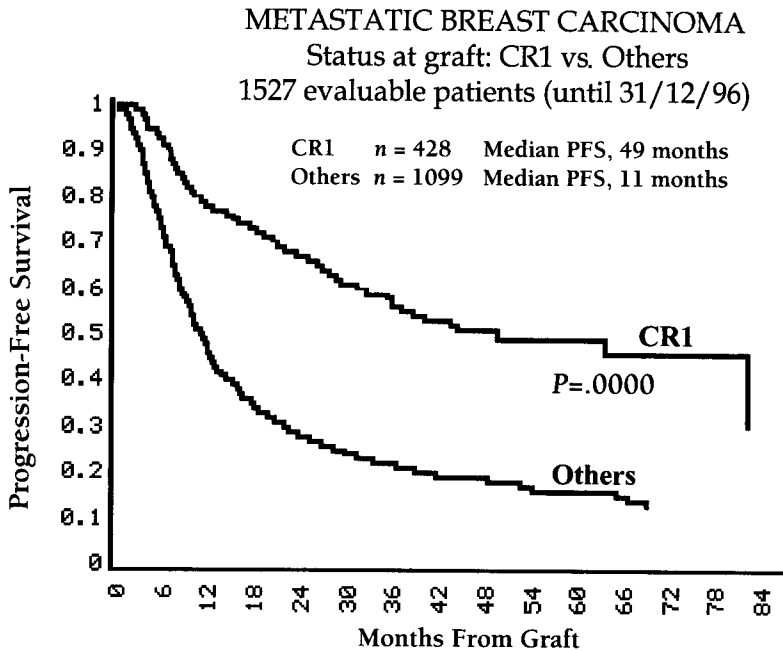


**Figure 2.** Toxic death rate for patients with breast cancer. Source: European Group for Blood and Marrow database.

Interestingly, 32% of patients were >50 years old and 3% >60 years old at the time of graft among those treated in 1997–1998, whereas in the period 1992–1999 only 16% and 1% of the treated patients were older than 50 and 60 years of age, respectively. As mentioned before, 95% of the patients received PBPC support, whereas the use of autoBMT was extremely rare. In Europe, the combination of autoBMT plus PBPCs was employed only anecdotally because the shift toward peripheral cells was immediate around 1995.<sup>2</sup>

### Toxic Death Rate

In the majority of articles published in the 1980s, the mortality rate for high-dose chemotherapy was 10%–15% and higher, whereas in recent reports it has declined dramatically to 0%–2%. The regimen employed plays an important role in outcome, as do disease status and performance status.<sup>3,4</sup> In the EBMT database, the toxic death rate for metastatic breast cancer is ~2%, whereas for the adjuvant setting it is 0.9% (Figure 2). These figures compare favorably with some issued in recent trials not employing BCNU at high doses.



**Figure 3.** Disease-free survival for patients with metastatic breast cancer. Source: European Group for Blood and Marrow database. CR, complete remission; PFS, progression-free survival.

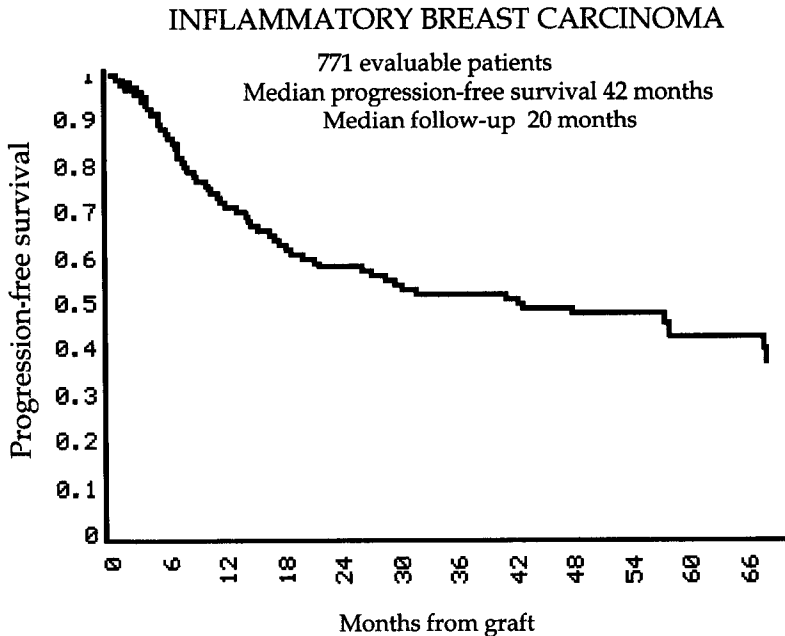
### Metastatic Disease

Despite the fact that patients with metastatic disease are nowadays less likely to undergo autografting compared with high-risk operable breast cancer patients in Europe, metastatic disease is still widely accepted as a possible setting for high-dose treatment. The “ASCO 1999 effect” (ie, the PBT-1 trial presentation<sup>5</sup> that was incorrectly considered by several medical oncologists worldwide to be the last word on autografting for metastatic breast cancer) has not yet shown its effects in Europe; however, in the next 2 years, we are going to observe a steep decline in the number of patients treated for advanced disease. From the EBMT breast cancer registry, 428 patients with an adequate follow-up (ie, treated until December 31, 1996) receiving high-dose chemotherapy and hematopoietic stem cell rescue in first remission show a highly significant progression-free survival (PFS) compared with those treated in other disease status (stable disease, partial remission, progression) (Figure 3); median PFS is 49 months vs. only 11 months. If we look at the data published by the Autologous Blood and Marrow Transplant Registry (ABMTR), a similar curve has been presented<sup>6</sup>; moreover, from one of the largest databases of patients treated with FAC (fluorouracil, adriamycin, and cyclophos-

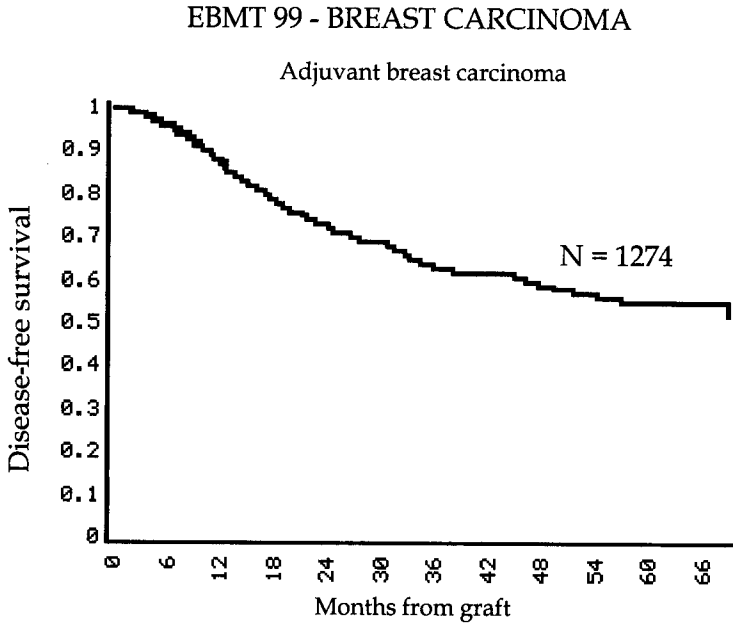
phamide) standard chemotherapy (M.D. Anderson Cancer Center),<sup>7</sup> the proportion of patients in complete remission achieving a long-term disease-free progression was nearly reduced to half. But of course, apples cannot be compared with oranges, and the final word has to come out of phase 3 randomized studies. Unfortunately, the PBT-1 trial, because of the small sample, was unable to show any difference between STAMP V (cyclophosphamide, thiotepa, and carboplatin) and prolonged CMF (cyclophosphamide, methotrexate, and fluorouracil) in patients in complete remission.<sup>5</sup>

### Inflammatory Breast Carcinoma

The EBMT Registry includes the largest series of patients treated with high-dose chemotherapy for inflammatory breast carcinoma. Median age for 846 patients is 44 years (range, 22–65 years), with a mean age of  $44 \pm 9$  years. The vast majority received a single graft, whereas 144 patients underwent double grafts, and 36, 3 or more grafts, for a total of 1072 autotransplants. Disease-free survival is ~40% at 3 years (Figure 4), and toxic death rate is 1%. In this rare disease, the role of high-dose or intensified treatments is still very controversial, and it will be



**Figure 4.** Progression-free survival for patients with inflammatory breast cancer. Source: European Group for Blood and Marrow database.

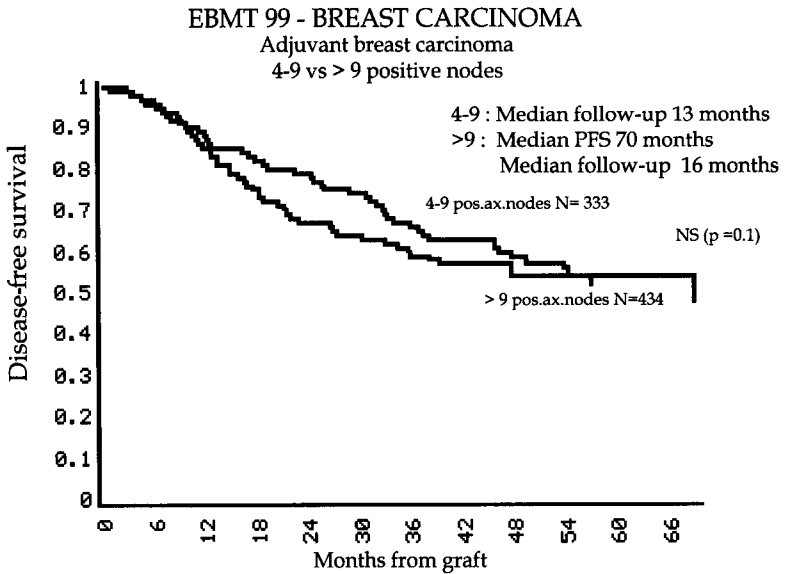


**Figure 5.** Progression-free survival for 1274 patients with operable high-risk breast cancer. Source: European Group for Blood and Marrow database.

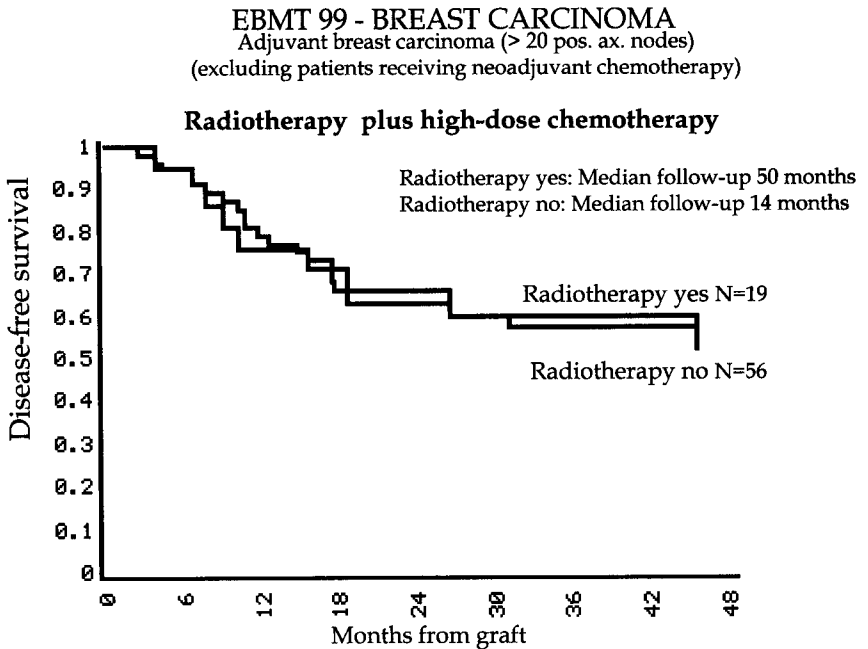
difficult, if not impossible, to set up randomized studies. Recently, the Pegase 02 study was published on behalf of a French collaborative group with EBMT support.<sup>8</sup> Four courses are administered, the first 2 including doxorubicin and cyclophosphamide, and the second 2, the same drugs plus fluorouracil. Pathologic complete remission rate on the breast is high (32%), 3-year disease-free survival rate is 45%, and overall survival is 70%.

### Adjuvant Therapy

As mentioned above, high-risk operable breast carcinoma has become the favorite setting for high-dose chemotherapy in Europe, overtaking advanced disease in the very recent past. The EBMT database includes 2046 patients receiving a total of 2289 grafts. Median age is 45 years (range, 18–70 years), with a mean of  $46 \pm 9$  years. Ninety-two percent of the patients received a single autotransplant; 8% had multiple grafts. The majority of adjuvant patients received PBPC transplantation, and only 1% had the combination of autoBMT and PBPC as hematopoietic support, slightly lower than in the North American Registry.<sup>9</sup>



**Figure 6.** Progression-free survival according to number of positive nodes. Source: European Group for Blood and Marrow database.



**Figure 7.** High-dose chemotherapy for patients with >20 positive axillary nodes: role of postsurgical radiation. Source: European Group for Blood and Marrow database.

The complete data set on 1274 patients is available, and median disease-free survival is 60 months (Figure 5). When stratifying for number of involved axillary nodes (<9 or >9), no differences are present (Figure 6). The data available in the literature on the possible benefit (randomized phase 3 studies) of high-dose treatment in breast cancer are limited, and no study has an adequate follow-up. At the 1999 American Society of Clinical Oncology (ASCO) meeting, 2 major studies were presented (the South African study will not be taken into consideration because of clinical misconduct). The CALGB/SWOG/NCIC trial<sup>4</sup> did not show any difference between high-dose (STAMP I) vs. intermediate-dose cisplatin, BCNU, and cyclophosphamide, except for a trend in the cohort of patients with a 3-year follow-up. The trial will be represented in 2001 with adequate follow-up. The Interscandinavian study<sup>10</sup> is a very difficult one to understand, as patients with no disease and bone-marrow metastases have been accrued. The follow-up was too short (2 years) to draw any conclusion, and there was some concern about which was really the high-dose arm; moreover, the risk of secondary leukemia and myelodysplastic syndrome in the intensified and tailored FEC (fluorouracil, epirubicin, cyclophosphamide) arm was not negligible. At ASCO 2000, the first cohort of 284 patients of the Dutch National Trial were presented<sup>11</sup>; with a follow-up of 3 years, high-dose chemotherapy (STAMP V European version with double dose of carboplatin) was significantly better than standard FEC in terms of disease-free and overall survival. We are waiting for the final presentation including all patients, which will be available in 2002. No data are available in the literature for patients with very high risk of relapse, ie, those with axillary burden (>20 positive axillary nodes). The EBMT launched a retrospective registry-based analysis to evaluate the PFS for patients bearing such a dismal prognosis.

Seventy-five patients treated until December 1997 have been evaluated, and those receiving primary chemotherapy were excluded to avoid possible incorrect comparisons—the vast majority received high-dose sequential chemotherapy as published by National Cancer Institute in Milan in 1997.<sup>11</sup> Toxic death rate was 0%, and disease-free survival was 50% at 4 years, suggesting a possible role of high-dose chemotherapy in this particular cohort of patients. Figure 7 shows the curves for patients with  $\geq 20$  positive nodes receiving postsurgical radiation therapy and those who did not receive such treatment. From Figure 7 (even if the number of patients is rather limited), the bulk of the axilla seems to be so important that the risk of relapse overcomes the benefits of radiation therapy. In 2000, a retrospective study was launched that includes patients from the International Blood and Marrow Transplant Registry (IBMTR) (study BC 99-04), so we will shortly have data on nearly 200 patients with >20 positive axillary nodes at surgery.

## ONGOING TRIALS

Several ongoing studies are underway in Europe in the field of high-dose chemotherapy and hematopoietic support for breast cancer patients; some of them have just completed their accrual.

As mentioned, in the Dutch National Study,<sup>11</sup> 885 patients with  $\geq 4$  positive axillary nodes have been randomized between the standard FEC regimen for 5 courses vs. 4 courses of FEC followed by 1 course of modified STAMP V (carboplatin 1600 mg/m<sup>2</sup>). In the first cohort of 284 patients, a clear significant benefit for the high-dose arm has been observed in terms of overall and disease-free survival (see Rodenhuis et al. in this volume for detailed results).

In 1999 at ASCO, a small randomized study was presented by Dr. Lotz on behalf of the Pegase group (Pegase 04 study).<sup>12</sup> Patients with advanced disease chemosensitive to first-line therapy were randomized between CMA (high-dose cyclophosphamide, mitoxantrone, and melphalan) and the same chemotherapy in standard doses. The median PFS rates were 15.7 and 26.9 months in the standard and intensive groups ( $P=.04$ ), whereas overall survival was not statistically different, even though patients in the high-dose arm experienced a nearly double survival from randomization. The study (and all the others from the Pegase Group) is undergoing a self-requested audit before being published.

In Italy in August 1998, a phase 3 randomized study (386 patients) was closed that compared standard therapy (which in Italy is epirubicin followed by CMF) with high-dose sequential chemotherapy (basically the same schedule as published by Gianni,<sup>13</sup> but with the incorporation of 2 doses of epirubicin and the exclusion of cisplatin). The first evaluation was to be performed in late 2000.

The Anglo-Celtic study has just stopped its accrual, with 600 patients with  $\geq 4$  positive axillary nodes randomized. The standard arm consists of adriamycin for 4 courses followed by CMF; the experimental arm is adriamycin as in the standard arm followed by cyclophosphamide for PBPC collection and cyclophosphamide and thiotepa at high doses. At the present time, no data are available. Another trial, Pegase 01, was closed in December 1998 with 314 randomized patients: standard FEC with high-dose epirubicin (100 mg/m<sup>2</sup>) was compared with FEC followed by cyclophosphamide, mitoxantrone, and melphalan in patients with  $\geq 8$  positive lymph nodes.

In July 2000, several trials were ongoing, and below we discuss the major or more mature ones. In 1997, the EBMT Solid Tumors Working Party launched in collaboration with the European Breast Dose Intensity Study (EBDIS) Group a study called EDBIS1/EBMT in patients with naive metastatic disease. The standard arm consists of adriamycin and docetaxel followed by CMF vs. adriamycin and docetaxel and subsequently a tandem transplant with VIC (etoposide, ifosfamide, and carboplatin) and then cyclophosphamide and thiotepa. One hundred patients

have been randomized. A similar study ongoing in Germany (GEBDIS study) is nearly superimposable to the EBDIS/EBMT study in terms of employed regimens and end points. Another similar study in Italy, on behalf of the Italian Group for Blood and Marrow Transplantation (GITMO), compares epirubicin and docetaxel vs. the same combination followed by a tandem course of ICE (ifosfamide, carboplatin, and etoposide) and thiotepa/melphalan at high doses (the study started in February 2000).

A multi-institutional German study is comparing 1 course of STAMP V vs. 2 courses of the same regimen in patients responding to standard up-front chemotherapy; >200 patients have been accrued so far.

In the scenario of high-dose therapy for operable breast cancer, several studies are approaching the final accrual. A trial on behalf of the International Breast Cancer Study Group (IBCSG 15-95) has accrued nearly 300 patients; it compares an anthracycline-based chemotherapy with an intensified therapy consisting of epirubicin 200 mg/m<sup>2</sup> and cyclophosphamide 4 g/m<sup>2</sup> for 3 courses, each of them supported with PBPCs. Entry criteria request  $\geq 8$  positive nodes or  $\geq 5$  in case of T3 or negative receptor status.

In Germany, a multi-institutional study is comparing standard chemotherapy (epirubicin followed by CMF [EC]) vs. EC followed by high doses of mitoxantrone, thiotepa, and cyclophosphamide. Three hundred forty patients have already been included, and the trial was to be completed by the end of 2000 with 400 cases.

All these major studies and several others not reported here will allow the scientific community to have data on homogeneous large groups of patients in the years to come, to try to answer the still unanswered question: is more better?

## REFERENCES

1. Gratwohl A, Passweg J, Baldomero H, Hermans J. Blood and marrow transplantation activity in 1997. European Group for Blood and Marrow Transplantation (EBMT). *Bone Marrow Transplant* 24:231–245, 1999.
2. Rosti G, Ferrante P. The EBMT Solid Tumors Registry 1999 Report. Faenza, 2000.
3. Rosti G, Ferrante P, Dazzi C, et al. High-dose chemotherapy in solid tumors: the EBMT database. *Crit Rev Oncol Hematol*. In press.
4. Peters W, Rosner G, Vredenburg J, et al. A prospective, randomised comparison of two doses of combination alkylating agents as consolidation after CAF in high-risk primary breast cancer involving ten or more axillary lymph nodes: preliminary results of CALGB 9082/SWOG 9114/NCIC MA-13 [abstract]. *Proc Am Soc Clin Oncol* 18:1a, 1999.
5. Stadtmauer EA, O'Neill A, Goldstein LJ, et al. Conventional-dose chemotherapy compared with high-dose chemotherapy plus autologous hematopoietic stem-cell transplantation for metastatic breast cancer. Philadelphia Bone Marrow Transplant Group. *N Engl J Med* 342:1069–1076, 2000.



6. Rowlings PA, Williams SF, Antman KH, et al. Factors correlated with progression-free survival after high-dose chemotherapy and hematopoietic stem cell transplantation for metastatic breast cancer. *JAMA* 282:1335–1343, 1999.
7. Greenberg PA, Hortobagyi GN, Smith TL, Ziegler LD, Frye DK, Buzdar AU. Long-term follow-up of patients with complete remission following combination chemotherapy for metastatic breast cancer. *J Clin Oncol* 14:2197–2205, 1996.
8. Viens P, Palangié T, Janvier M, et al. First line high-dose chemotherapy with rG-CSF and repeated blood stem cell transplantation in untreated inflammatory breast cancer (Pegase 02 trial). *Br J Cancer* 81:449–456, 1999.
9. Antman KH, Rowlings PA, Vaughan WP, et al. High-dose chemotherapy with autologous hematopoietic stem-cell support for breast cancer in North America. *J Clin Oncol* 15:1870–1879, 1997.
10. The Scandinavian Breast Cancer Study Group 9401. Results from a randomized adjuvant breast cancer study with high dose chemotherapy with CTCb supported by autologous bone marrow stem cells versus escalated and tailored FEC therapy [abstract]. *Proc Am Soc Clin Oncol* 18:3a, 1999.
11. Rodenhuis S, Bontenbal M, Beex L, et al. Randomized phase III study of high-dose chemotherapy with cyclophosphamide, thiotepa and carboplatin in operable breast cancer with 4 or more axillary lymph nodes [abstract]. *Proc Soc Clin Oncol* 19:74a, 2000.
12. Gianni AM, Siena S, Bregni M, et al. Efficacy, toxicity, and applicability of high-dose sequential chemotherapy as adjuvant treatment in operable breast cancer with 10 or more involved axillary nodes: five-year results. *J Clin Oncol* 15:2312–2321, 1997.
13. Lotz JP, Curé H, Janvier M, et al. High-dose chemotherapy (HD-CT) with hematopoietic stem cell transplantation (HSCT) for metastatic breast cancer (MBC): results of the French protocol PEGASE 04 [abstract]. *Proc Am Soc Clin Oncol* 18:43a, 1999.

# **High-Dose Thiotepa, Mitoxantrone, and Paclitaxel Followed by Peripheral Blood Stem Cell Transplant for the Treatment of Chemosensitive Metastatic Breast Cancer: Clinical Outcomes**

***Karen K. Fields, Janelle B. Perkins, Steve Goldstein, Daniel Sullivan,  
Teresa Field, Benjamin Djulbegovic, James Partyka***

*H. Lee Moffitt Cancer Center and Research Institute,  
University of South Florida, Tampa, Florida*

## **ABSTRACT**

The use of high-dose chemotherapy and peripheral blood stem cell transplant for the treatment of patients with metastatic breast cancer remains an area of active controversy. We have developed a novel high-dose chemotherapy regimen consisting of thiotepa, mitoxantrone, and paclitaxel (TNT) in an attempt to define a regimen with increased antitumor activity. We have previously defined the maximum tolerated doses of this regimen to be thiotepa 720 mg/m<sup>2</sup>, mitoxantrone 48 mg/m<sup>2</sup>, and paclitaxel 360 mg/m<sup>2</sup>. Stem cell reinfusion follows 7 days after completion of the high-dose regimen. All patients received peripheral blood stem cells harvested following mobilization with 2 cycles of cyclophosphamide 100 mg/kg and paclitaxel 250 mg/m<sup>2</sup> administered with granulocyte colony-stimulating factor (G-CSF). We have treated a total of 32 patients with chemosensitive metastatic breast cancer, median age 45 years (range, 31–56 years), on this regimen. Chemosensitivity before transplant was as follows: 9 patients were transplanted in complete remission, 12 patients were in partial remission, and 11 patients had bone as their only site of metastasis. There were no treatment-related deaths. Grade 3 or 4 mucositis and enteritis were the most frequent treatment-related toxicities, occurring in 86% and 66% of the patients, respectively. The median time to engraftment of neutrophils >500/μL was day 11 (range, 9–17 days) and platelets to >20,000, day 18 (range, 9–106 days). All patients who were transplanted in complete remission remained in complete remission; 25% of the patients transplanted in partial remission and 36% of the patients transplanted with bone-only disease had further responses to high-dose therapy; the remainder of the patients had stable disease or progressed after transplant. Overall and event-free

survival rates at 24 months were  $56\% \pm 10\%$  and  $25\% \pm 8\%$ , respectively. No significant differences in overall or event-free survival were seen among the various groups based on chemosensitivity. We conclude that TNT is active in patients with metastatic breast cancer. Attempts to decrease treatment-related toxicities are needed to improve the suitability of this regimen for administration in the outpatient setting.

## INTRODUCTION

The use of high-dose chemotherapy and hematopoietic stem cell transplant in the treatment of patients with metastatic breast cancer remains an area of active controversy. To date, there have been 5 randomized clinical trials comparing high-dose therapy to standard therapy in patients with metastatic breast cancer.<sup>1-5</sup> All of these clinical trials suffer from statistical concerns, and most include small numbers of patients, limiting definitive conclusions. Among all of these randomized clinical trials, a total of only 502 patients have completed therapy and had their outcomes reported. Additionally, the first of these published clinical trials to demonstrate an advantage for high-dose therapy was reported by investigators from South Africa in 1995, and the results of this study will require further scrutiny to determine their validity, given the problems associated with a later study reported by one of these investigators.<sup>1</sup> On balance, no firm conclusions concerning the role of high-dose therapy in the treatment of metastatic breast cancer can be drawn based on the data from these randomized trials.

Unfortunately, among the limited number of chemotherapeutic agents available for dose escalation due to known toxicity profiles, few are extremely active against breast cancer in standard doses. We have previously conducted a phase 1 trial evaluating the combination of thiotepa, mitoxantrone, and paclitaxel (TNT) followed by autologous stem cell reinfusion in patients with refractory metastatic breast cancer.<sup>6</sup> These agents were chosen because of their activity in breast cancer and their lack of overlapping nonhematologic toxicities in standard doses. The dose-limiting toxicity of TNT was found to be cardiomyopathy, necessitating a decrease in the total dose of mitoxantrone. Additionally, in patients receiving prior therapy with taxanes, grade 3 or 4 central nervous system toxicity was noted and found, in some instances, to be irreversible. A subsequent decrease in the total dose of thiotepa resulted in improvement of this toxicity with no long-term sequelae. The maximum tolerated doses were determined to be thiotepa 720 mg/m<sup>2</sup>, mitoxantrone 48 mg/m<sup>2</sup>, and paclitaxel 360 mg/m<sup>2</sup>.

Because of the promising activity of this regimen in patients with refractory metastatic breast cancer, a phase 2 trial evaluating TNT in patients with chemosensitive metastatic breast cancer was undertaken. In this report, we present the results of the phase 2 trial in patients with metastatic breast responsive to anthracyclines

or taxanes or patients rendered disease-free by surgery or radiation therapy. Treatment-related toxicities, response rates, and overall and progression-free survival rates are included.

## PATIENTS AND METHODS

### Patients

From April 1997 through December 1998, we treated 32 patients with chemosensitive metastatic breast cancer on a phase 2 clinical trial of high-dose TNT followed by autologous peripheral blood stem cell reinfusion. All patients gave written informed consent for the study that was approved and reviewed annually by the Institutional Review Board of the University of South Florida.

Patients with biopsy-proven metastatic breast cancer were eligible if they were up to 65 years of age with an adequate performance status, defined as a Karnofsky score of  $>80\%$  or an Eastern Cooperative Oncology Group performance status of  $<2$ . All patients were required to have adequate organ function, including a cardiac ejection fraction of  $>50\%$  measured by nuclear medicine scanning or 2-dimensional echocardiography, adequate pulmonary function with a diffusion capacity of  $>60\%$ , adequate renal function with a measured creatinine clearance of  $>60$  mL/min, and liver function tests of  $<2.5$  times the upper limit of normal. Patients with brain metastases were excluded. Additionally, patients were required to demonstrate at least a partial response, defined as a  $\geq 50\%$  decrease in measurable disease, to an anthracycline- or taxane-containing regimen. In the case of patients with bone-only disease, patients were required to have no progression of disease on nuclear medicine bone scans after an anthracycline- or taxane-containing regimen. Patients with metastatic breast cancer rendered free of disease with surgery or radiation therapy were also included. They were considered to be inevaluable for responsiveness to anthracyclines, taxanes, or high-dose therapy.

### Treatment Regimen

Before receiving high-dose therapy, all patients received 2 cycles of cyclophosphamide (50 mg/kg per day for 2 days) and paclitaxel (125 mg/m<sup>2</sup>/day for 2 days) with a goal to further reduce tumor burden as well as mobilize peripheral blood stem cells. Following the completion of each course of chemotherapy, patients were treated with G-CSF at a dose of 5  $\mu$ g/kg per day (generally rounded to 300 or 480  $\mu$ g/day) starting 24 hours after completion of chemotherapy and continuing until evidence of hematopoietic recovery. Stem cells were harvested following the second cycle of chemotherapy at the time of hematopoietic recovery to a targeted minimum of  $2 \times 10^6$  CD34<sup>+</sup> cells/kg. Patients with evidence of progressive disease

following completion of 2 cycles of cyclophosphamide and paclitaxel were considered ineligible for high-dose therapy.

TNT was administered in the following manner. Mitoxantrone was administered over 1 hour at 16 mg/m<sup>2</sup> on days -9, -8, and -7 to a total dose of 48 mg/m<sup>2</sup>. Thiotepa was administered over 2 hours at 240 mg/m<sup>2</sup> on days -9, -8, and -7 to a total dose of 720 mg/m<sup>2</sup>. Paclitaxel was administered as a 21-hour continuous infusion at 120 mg/m<sup>2</sup> on days -9, -8, and -7 to a total dose of 360 mg/m<sup>2</sup>. Stem cell reinfusion occurred on day 0.

All patients received antimicrobial prophylaxis with fluconazole and a quinolone antibiotic beginning on day -2 and continuing through first neutropenic fever or until evidence of engraftment. At the time of first neutropenic fever, patients received antibiotics according to the clinical situation. All patients that were herpes simplex virus-seropositive received prophylactic acyclovir. All patients received G-CSF administered at 5 µg/kg per day beginning on day 7 and continuing until absolute neutrophil count was >1000/µL for 3 days.

### Statistical Considerations

Overall survival and event-free survival rates were calculated using Kaplan-Meier methods. An event was defined as progression of disease or death due to therapy or any other cause. Differences in overall and event-free survival were calculated using the 2-tailed value of probability from the log-rank method.

## RESULTS

Table 1 illustrates the patients' characteristics. A total of 32 patients were treated; all received peripheral blood stem cell transplants. The majority of patients (75%) were treated for metastatic breast cancer that recurred after adjuvant therapy. All patients received anthracyclines, 50% in the adjuvant setting and the remaining 50% for the treatment of metastatic disease. All patients received taxanes before high-dose therapy. The majority of patients were refractory to anthracyclines and responsive to second-line therapy with taxanes. As can be seen in Table 1, of 16 patients evaluable for chemosensitivity to chemotherapy, only 25% were responsive to first-line therapy with anthracycline-based therapy; 75% were responsive to second-line chemotherapy with taxane-based therapy. Five of the 32 patients were not evaluable for response to high-dose therapy because they were rendered disease-free following surgery or radiation therapy before high-dose therapy. An additional 11 patients had bone-only disease and were not evaluable for response to high-dose therapy.

Hematologic toxicity was acceptable. The median time to neutrophil engraftment, defined as a neutrophil count of >500/µL, was day 11 (range,

**Table 1.** Patient Characteristics

<i>N</i>	32
Age, y	
Median	45
Range	31–56
Disease history	
Relapsed after early-stage disease	24
Metastatic at diagnosis	8
Estrogen receptor status at diagnosis	
Negative	16
Positive	11
Unknown	5
Prior therapies	
Adjuvant anthracyclines	16
Anthracyclines for metastatic disease only	16
Taxanes for metastatic disease	32
Disease status at transplant	
Response to anthracyclines	
Complete response	0
Partial response	4
Response to taxanes	
Complete response	4
Partial response	8
No evidence of disease following surgery or radiation therapy	5
Bone-only metastatic disease	11
Dominant site of metastatic disease	
Viscera	12
Bone	11
Lymph nodes/soft tissue	9

9–17 days). The median time to platelet engraftment, defined as a platelet count of  $>20,000/\mu\text{L}$ , was day 18 (range, 9–106 days). The median length of stay for all patients was 23 days (range, 18–41 days). Grade 3 or 4 treatment-related toxicities were as follows: mucositis (86%), enteritis (66%), central nervous system toxicity manifested as severe confusion (9%), cardiac toxicity (9%), and peripheral neuropathy (9%). There was no treatment-related mortality. No other grade 3 or 4 organ toxicities were noted.

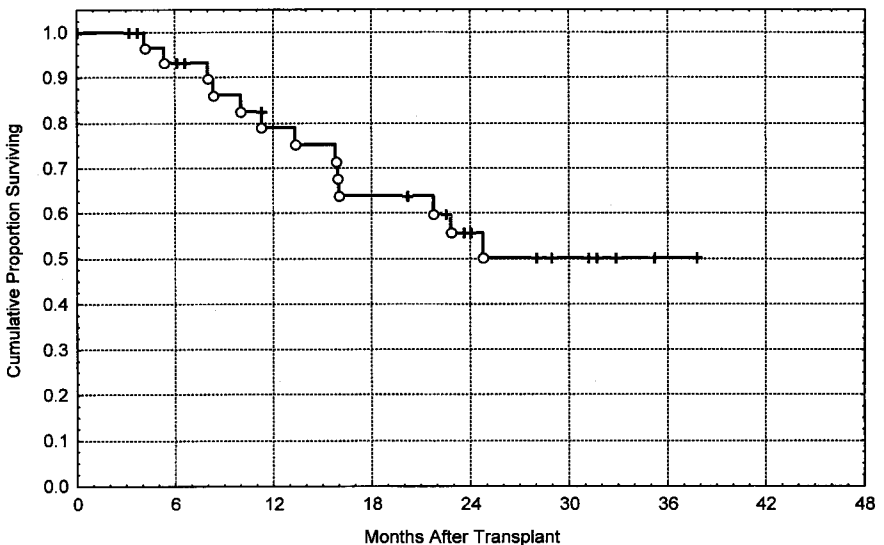
Response rates were evaluated at 3 months after the completion of high-dose therapy. All patients who received high-dose therapy in complete remission remained in complete remission after completion of high-dose therapy. Of patients

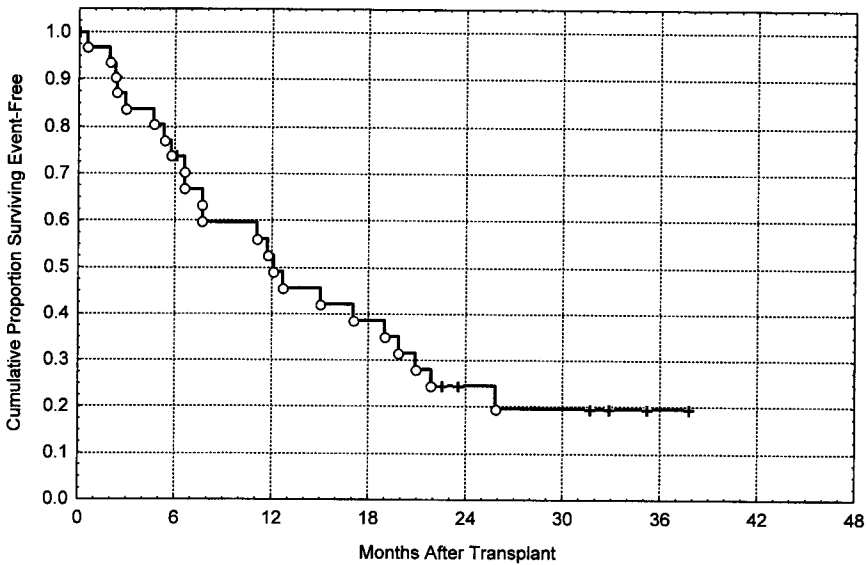
**Table 2.** Chemosensitivity Status Before High-Dose Therapy and Peripheral Blood Stem Cell Transplant (PBSCT) and Outcome After PBSCT\*

<i>Disease Status Before PBSCT</i>	<i>Overall Survival at 2 y, %</i>	<i>Event-Free Survival at 2 y, %</i>
Complete remission	29 ± 17	13 ± 12
Partial remission	60 ± 15	33 ± 14
Bone-only disease	71 ± 16	22 ± 14

\*Data are mean ± SE.

treated in a partial remission, none were converted to a complete remission, 25% had a further response, 33% had stable disease, and 42% progressed. Of patients with bone-only disease, 36% had a further response, 55% had stable disease, and 9% progressed. Overall survival at 24 months was 56% ± 10% (mean ± SE); event-free survival at 24 months was 24% ± 8%. Overall and event-free survival rates based on chemosensitivity before high-dose therapy are illustrated in Table 2. Figures 1 and 2 illustrate the Kaplan-Meier survival curves for overall and event-free survival for all patients. Figures 3 and 4 represent Kaplan-Meier survival curves for overall and event-free survival for all patients according to chemosensitivity before high-dose therapy. As can be seen, there was no difference in overall survival ( $P=.52$ ) or event-free survival ( $P=.38$ ) among any of the groups studied

**Figure 1.** Overall survival for all patients.



**Figure 2.** Event-free survival for all patients.

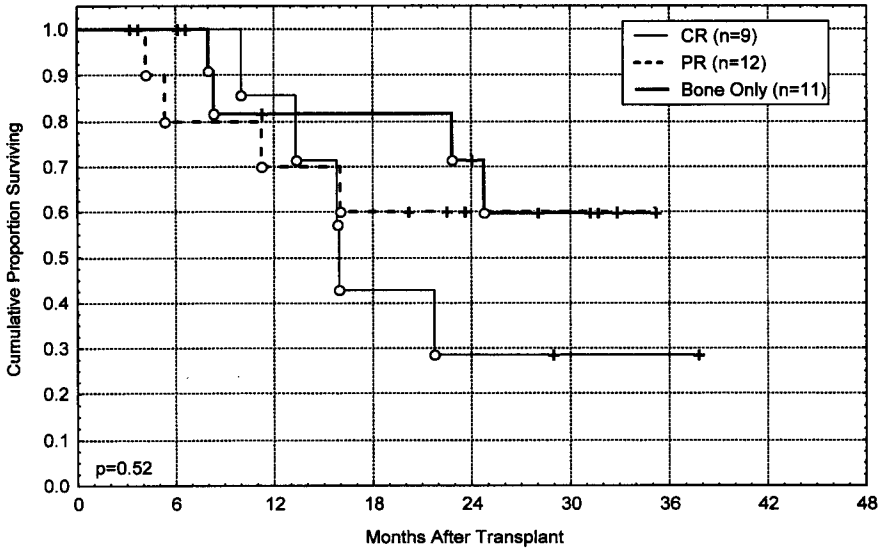
(complete responders before transplant, partial responders before transplant, and patients with bone-only disease).

### DISCUSSION

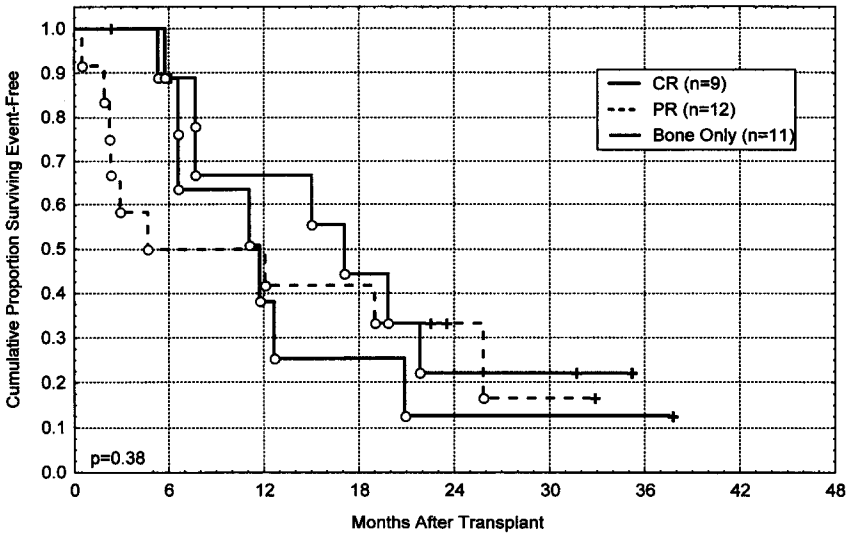
This study defines a novel high-dose regimen for the treatment of breast cancer that employs chemotherapeutic agents with specific activity for breast cancer in standard doses. We demonstrate that TNT is active in patients with chemosensitive metastatic breast cancer and that the treatment-related toxicities of the regimen are tolerable.

Although the patients in this study were defined as chemosensitive, it must be noted that a minority of the patients with evaluable disease were responsive to first-line therapy with anthracyclines (25%). The majority of patients (75%) in this trial with evaluable disease were sensitive to second-line therapy with taxanes. Thus, this group of patients represents a group of more heavily pretreated patients than the majority of those enrolled in published randomized clinical trials that compare standard-dose therapy to high-dose therapy with stem cell rescue. Therefore, comparison of this regimen with other published high-dose regimens is problematic. Additionally, a minority of patients in this trial (28%) were transplanted in complete remission, another factor known to positively influence the outcome of patients





**Figure 3.** Overall survival for all patients based on chemosensitivity before high-dose therapy. CR, complete remission; PR, partial remission.



**Figure 4.** Event-free survival for all patients based on chemosensitivity before high-dose therapy. CR, complete remission; PR, partial remission.

undergoing high-dose therapy in several trials.<sup>7</sup> There are no clinically significant differences in outcome based on disease status before transplant among the patients treated in this trial, due in large part to the limited number of patients enrolled.

Treatment-related toxicities are tolerable with this regimen. Hematologic toxicity is comparable to that seen with other high-dose therapy regimens used in the treatment of breast cancer. Mucositis and enteritis currently limit the utility of this regimen in the outpatient setting, and further attempts to decrease these side effects are needed to improve the acceptance of this regimen in the high-dose setting.

Clinical outcomes for patients with metastatic breast cancer remain disappointing. Although the number of therapeutic agents with activity against breast cancer continues to increase, data continue to suggest that few patients enjoy long-term responses to any of the currently available agents. The patients treated on this trial are typical of patients that present with metastatic breast cancer following adjuvant therapy, failing adjuvant anthracyclines but responsive to salvage therapy with taxanes. Thus, prolonged progression-free survival in this group of patients is encouraging. Ultimately, high-dose therapy and autologous stem cell transplant represents a viable strategy to decrease overall tumor burden, with a long-term goal of employing agents aimed at the eradication of minimal residual disease, such as immunotherapies and other biological response modifiers.

## REFERENCES

1. Bezwoda WR, Seymour L, Dansey RD. High-dose chemotherapy with hematopoietic rescue as primary treatment for metastatic breast cancer: a randomized trial. *J Clin Oncol* 13:2483–2489, 1995.
2. Peters WP, Jones RB, Vredenburgh J, et al. A large, prospective, randomized trial of high-dose combination alkylating agents (CPB) with autologous cellular support (ABMS) as consolidation for patients with metastatic breast cancer achieving complete remission after intensive doxorubicin-based induction therapy (AFM) [abstract]. *Breast Cancer Treat Res* 37 (Suppl):35, 1996. Abstract 11.
3. Stadtmauer EA, O'Neill A, Goldstein LJ, et al. Conventional-dose chemotherapy compared with high-dose chemotherapy plus autologous hematopoietic stem-cell transplantation for metastatic breast cancer. *N Engl J Med* 342:1069–1076, 2000.
4. Lotz JP, Cure H, Janvier M, et al. High dose chemotherapy with hematopoietic stem cell transplantation for metastatic breast cancer: results of the French protocol PEGASE 04 [abstract]. *Proc Am Soc Clin Oncol* 9:9A, 1999.
5. Madan B, Broadwater G, Rubin P, et al. Improved survival with consolidation high-dose cyclophosphamide, cisplatin and carmustine (HD-CPB) compared with observation in women with metastatic breast cancer (MBC) and only bone metastases treated with induction adriamycin, 5-fluorouracil and methotrexate (AFM): a phase III prospective randomized comparative trial [abstract]. *Proc Am Soc Clin Oncol* 10:48A, 2000.

6. Fields KK, Elfenbein GJ, Perkins JB, et al. Defining the role of novel high-dose therapy regimens for the treatment of high-risk breast cancer. *Semin Oncol* 25 (Suppl 4):1–6, 1998.
7. Rowlings PA, Williams SF, Antman KH, et al. Factors correlated with progression-free survival after high-dose chemotherapy and hematopoietic stem cell transplantation for metastatic breast cancer. *JAMA* 282:1378–1380, 1999.

# **A New Approach Using Multiple High-Dose Ifosfamide, Carboplatin, and Etoposide (ICE) With Peripheral Blood Stem Cell Reinfusion for Chemoresistant Breast Cancer Patients After Neoadjuvant Treatment**

**Giovanni Martinelli, Emilia Cocorocchio, Saverio Cinieri,  
Fedro Peccatori, Daniella Vaccari, Pier Francesco Ferrucci,  
Giovanni Mazzarol, Paolo Veronesi, Laura Baglietto,  
Francesco Bertolini, Aron Goldhirsch**

*Division of Hematology (G.Mar., E.C., S.C., F.P., D.V., P.F.F., F.B.),  
Division of Pathology and Laboratory Medicine (G.Maz.), Division of  
Senology (P.V.), Division of Epidemiology and Biostatistics (L.B.), Division of  
Medical Oncology (A.G.), European Institute of Oncology, Milan, Italy*

## **ABSTRACT**

Neoadjuvant chemotherapy with anthracycline-containing regimens is often used in breast cancer to reduce the primary tumor and allow breast conservation. Not achieving a complete remission is associated with worse prognosis, especially when several lymph nodes are involved. No information has been reported on the best way to treat this unfavorable subgroup of patients. Their poor prognosis may justify multiple high-dose chemotherapy (HDCT) with peripheral blood stem cell (PBSC) support as adjuvant treatment after surgery to overcome tumor cell resistance.

The purpose of this study was to assess the feasibility and efficacy of multiple high-dose ICE (ifosfamide, carboplatin, and etoposide) chemotherapy in patients who received an anthracycline-containing regimen as neoadjuvant therapy and who still had a large tumor burden at surgery.

Forty-three patients were considered eligible. Median age was 44 years (range, 26–60 years). All patients received a median of 4 cycles of anthracycline-containing chemotherapy as preoperative treatment because of tumor size. Thirty-two patients (74%) underwent total mastectomy because of insufficient clinical response, whereas 9 (21%) had some clinical reduction to allow breast conservation but presented at surgery with  $\geq 5$  axillary lymph nodes involved.

All patients, after surgery, received 3 additional cycles of high-dose ICE (ifosfamide 10 g/m<sup>2</sup>, carboplatin 1200 mg/m<sup>2</sup>, and etoposide 1200 mg/m<sup>2</sup> over 4 days) with subsequent PBSC reinfusion and granulocyte colony-stimulating factor (G-CSF) support.

The most relevant toxicity recorded was febrile neutropenia and gastrointestinal toxicity. Mild mucositis and transient liver test function modification occurred in 37% and 40% of cases, respectively. One toxic death occurred on day 30 after the third transplantation because of acute heart failure likely, due to deep vein thrombosis.

After a median follow-up of 30 months (range, 6–51 months) from diagnosis, 27 patients were alive and disease free. Relapse occurred in 16 patients. Seven patients died, 6 of their disease and 1 of toxicity. Calculated disease-free survival and overall survival rates were 52% (95% confidence interval [CI], 36%–75%) and 83% (95% CI, 71%–96%) at 40 months, respectively.

Multiple high-dose ICE cycles with multiple PBSC reinfusions in pretreated patients seems safe and feasible. HDCT may play a role in the treatment of patients with high-risk breast cancer with dire prognosis. Thus, these results provide justification for a randomized study in this setting comparing multiple high-dose non-anthracycline-containing regimens versus a standard postoperative adjuvant program.

## INTRODUCTION

The use of neoadjuvant chemotherapy has become widely used in stage II–III breast cancer patients.<sup>1–4</sup> The aim of such a treatment modality is to reduce tumor size, allowing a more conservative surgery and anticipating a systemic treatment achieving an earlier eradication of micrometastases. In 1998, Fisher et al.<sup>5</sup> published the clinical results of a randomized trial comparing adjuvant chemotherapy with the same treatment administered before surgery (neoadjuvant) in patients with operable breast cancer. One of the most relevant conclusions of this study was that in patients treated with neoadjuvant chemotherapy, response to therapy correlated with outcome, and such responses were independent from other biological baseline characteristics. Thus, clinical response to neoadjuvant chemotherapy may be considered an additive independent prognostic factor: chemoresistant tumor cells may be suggestive of tumor persistence and subsequent relapse.<sup>6–8</sup> The use of non-cross-resistant drugs, possibly at the maximum dosage allowed, might overcome such chemoresistance and improve clinical outcome.<sup>9–12</sup>

The high-dose ICE regimen has already been used in metastatic breast cancer patients, with good clinical activity<sup>13–15</sup>; in addition, the repeated submyeloablative HDCT seems to achieve similar results to those achieved with a single chemotherapy course, without additional toxicity.

The aim of this phase 2 study was to verify the feasibility and the clinical results of multiple transplants using a non-cross-resistant, submyeloablative chemotherapy in high-risk breast cancer patients who did not respond to a neoadjuvant anthracycline-containing regimen and who still need further chemotherapy because of important tumor persistence after surgery.

## MATERIALS AND METHODS

Patients aged  $\geq 18$  and  $\leq 65$  years with a good Karnofsky performance status ( $>60\%$ ), all with histologically/cytologically proven invasive breast cancer not suitable for conservative surgery, were considered for the study. All had to have normal renal and liver function, a cardiac ejection fraction  $>50\%$ , white blood cell count (WBC)  $>3.500 \times 10^9/L$ , platelet count  $>100,000 \times 10^9/L$ , and hemoglobin  $>10$  g/dL before starting treatment.

An anthracycline-containing regimen as primary chemotherapy was planned for all patients. Patients were clinically reevaluated after 2 and 4 cycles. Those patients with a clinical response continued chemotherapy for a maximum of 6 cycles, whereas patients showing no change or tumor progression immediately underwent surgery. After surgery, 3 additional cycles of high-dose ICE were considered for those patients who presented with a pathological tumor size  $>2$  cm and/or  $>5$  axillary lymph nodes involved. Thus, 43 patients were considered eligible for the program (Table 1).

Human immunodeficiency virus (HIV) positivity and severe chronic disease constituted exclusion criteria. Clinical examination, chest X-ray, abdominal ultrasound, bone scintigraphy, blood count, and blood chemistry were performed before conventional chemotherapy and immediately repeated before starting HDCT. Clinical examination, blood count, and blood chemistry evaluations were performed before and after each cycle of HDCT. Cardiac function was evaluated before each cycle by echocardiography and every year thereafter.

Follow-up was performed every 3 months during the first 2 years by clinical examination, blood count, and blood chemistry evaluation. Chest X-ray and abdominal echography were performed every 6 months. Bone scintigraphy was performed as clinically indicated.

CD34<sup>+</sup> cells were mobilized using G-CSF alone ( $5 \mu\text{g}/\text{kg}$  twice per day) for at least 5 days. Apheresis was performed when the CD34<sup>+</sup> cell count was  $20/\mu\text{L}$ . From day  $-5$  to day  $-2$ , patients received carboplatin  $300 \text{ mg}/\text{m}^2$ , etoposide (VP-16)  $300 \text{ mg}/\text{m}^2$ , ifosfamide  $2500 \text{ mg}/\text{m}^2$  daily every 28 days. A median of  $2.1 \times 10^6/\text{kg}$  PBSCs were reinfused on day 0. G-CSF was given at the daily dose of  $5 \mu\text{g}/\text{kg}$  from day 5 until hematologic recovery (WBC  $>10,000/\text{mm}^3$  for 1 day or  $>1,000/\text{mm}^3$  neutrophils for 3 consecutive days).

**Table 1.** Patient Characteristics\*

Patients, <i>n</i>	43
Median age, y (range)	44 (26–60)
Menopausal status	
Premenopause	31
Postmenopause	12
Clinical stage	
First or second therapy	15
Third or fourth therapy	25
Transplant	3
Positive axillary lymph nodes	
0	10
1	26
2	2
Unknown	5
Median number of neoadjuvant chemotherapy cycles (range)	4 (2–6)
Chemotherapy schedule	
AC/EC	16
FAC/FEC	9
Epirubicin/adriamycin	10
Epirubicin and taxanes	6
Other	2
Surgery	
Mastectomy	32
Lumpectomy	9
Bilateral surgery	2
Pathological stage	
IIA	8
IIB	16
IIIA	13
IIIB	3
Tx N1	2
Tis N1	1
Bilateral invasive tumor	1
Median number of positive axillary lymph nodes involved (range)	15 (3–59)
Receptor status (after surgery)	
ER <sup>+</sup> /PR <sup>+</sup>	19
ER <sup>+</sup> /PR <sup>-</sup>	12
ER <sup>-</sup> /PR <sup>-</sup>	9
ER <sup>-</sup> /PR <sup>+</sup>	3

\*ER, estrogen receptor; FAC, fluorouracil, adriamycin, cyclophosphamide; FEC, fluorouracil, epirubicin, cyclophosphamide; PR, progesterone receptor.

**Table 2.** Hematologic Toxicity\*

	<i>Cycle 1</i>	<i>Cycle 2</i>	<i>Cycle 3</i>
White blood cell and platelet rescue			
Time to WBC >1000/mm <sup>3</sup> , d	10 (8–12)	11 (9–11)	11 (8–14)
Time to platelets >10,000/mm <sup>3</sup> , d	10 (7–12)	11 (0–14)	11 (8–21)
Transfusal support			
Number of red blood cell transfusions	2 (0–6)	2 (0–6)	2 (0–16)
Number of platelet transfusions	1 (0–8)	1 (0–4)	1 (0–5)

\*Data are median (range). WBC, white blood cell count.

During aplasia, patients received prophylactic therapy with ciprofloxacin 500 mg twice per day, fluconazole 100 mg daily, and acyclovir 200 mg 3 times per day. Tamoxifen 20 mg daily started 1 month after the final cycle of chemotherapy and continued for 5 years or until relapse.

Disease-free survival (DFS) and overall survival (OS) were calculated according to Kaplan-Meier product-limit survival functions. The progression-free survival time is defined as the time from surgery to progression, and the overall survival time as the time from diagnosis to death.

## RESULTS

Forty-three patients were fully evaluable. Toxicity was assessed according to National Cancer Institute of Canada Clinical Trials Group (NCIC-CTG)

**Table 3.** Nonhematologic Toxicity According to National Cancer Institute of Canada Clinical Trials Group Criteria\*

	<i>Grade 1–2</i>	<i>Grade 3–4</i>
Nausea/vomiting	66	1
Diarrhea	15	1
Mucositis	36	0
Constipation	19	0
Abdominal pain	24	1
Renal (creatinine)	2	0
Hepatic (enzymes)	40	1
Hypotension	19	1
Metabolic (hypocalcemia)	33	1
Fever of unknown origin	—	39
Infection	0	1

\*Data are %.



criteria. Median number of hospital inpatient days was 19 (range, 16–27), 17 (range, 11–27), and 17 (range, 14–46) for the first, second, and third cycle, respectively.

The median number of days to achieve  $>1000/\text{mm}^3$  WBC was 11; for  $>10,000/\text{mm}^3$  platelets, it was 11. No differences were observed on subsequent cycles. Patients received a median of 2 packed red blood cell infusions and 1 platelet concentrate infusion for each cycle (Table 2).

Main nonhematologic toxicity is shown in Table 3. Febrile neutropenia occurred in 48% of cases, all treated with empiric systemic antibiotic therapy with complete resolution. Eight episodes of documented clinical infections were successfully treated with specific antimicrobial therapy. During the third cycle, 1 patient developed a severe *Candida albicans* sepsis, with gastrointestinal and pulmonary involvement requiring intensive care from day 8; the patient was discharged on day 38. Transient increases in liver enzymes were observed in 40% of cases, most likely because of chemotherapy and dimethylsulfoxide (DMSO) reinfusion. Mucositis was generally mild, and no patient required total parenteral nutrition. Severe nausea/vomiting was observed in  $<1\%$  of cases.

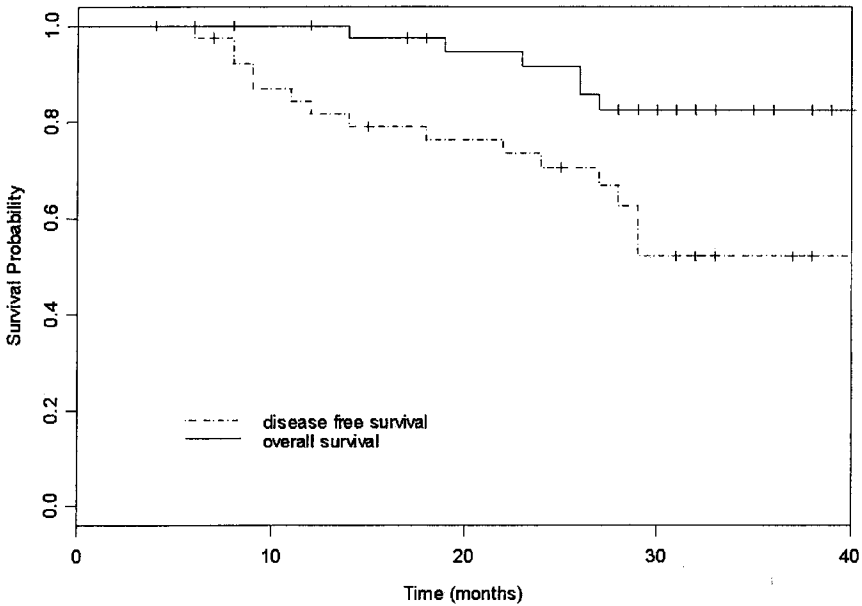
At a median follow-up of 30 months (range, 6–51 months) from diagnosis, 27 patients were alive and disease free. Relapse occurred in 16 patients; 3 patients had locoregional relapse, and 13 developed metastatic disease. Death occurred in 7 patients, 6 of their disease; 1 patient died on day 30 after the third transplantation because of acute heart failure, probably related to deep vein thrombosis.

Calculated DFS and OS rates were 52% (95% CI, 36%–75%) and 83% (95% CI, 71%–96%), respectively, at 40 months (Figure 1).

## DISCUSSION

Neoadjuvant chemotherapy regimens may induce only a 10%–15% pathological complete remission rate. Thus, the majority of patients present at surgery with tumor persistence and axillary lymph node involvement. The prognosis for this subgroup is very poor, and ~80% may relapse within 2 years.<sup>5,16–18</sup> For this reason, pathological complete response to primary chemotherapy is considered the most favorable prognostic factor, independent of other tumor characteristics. Primary or induced resistance may lead to tumor cell persistence after primary chemotherapy and explain subsequent relapse.

The treatment of choice for these patients remains unclear. Our study suggests the possible role of triple HDCT with PBSC rescue for those patients who need further therapy after neoadjuvant chemotherapy and surgery. It is difficult to compare the OS and DFS (83% and 52%, respectively) observed in our study with the data from the literature, because of a lack of clinical studies on patients with similar characteristics.



**Figure 1.** Calculated disease-free survival (DFS) and overall survival (OS) of 52% (95% confidence interval, 36%–75%) and 83% (95% confidence interval, 71%–96%) at 40 months, respectively.

The addition of conventional chemotherapy seems ineffective in overcoming chemoresistances, which are probably the cause of tumor persistence after anthracycline-containing treatments.<sup>19</sup> Other drugs such as taxanes may be an alternative option because of demonstrated clinical activity after the failure of anthracycline-containing regimens. However, despite high response rates, their efficacy in improving overall survival remains ill-defined; their use in the adjuvant setting is under investigation.<sup>20–22</sup>

The role of HDCT in the adjuvant setting is also unclear. Conflicting results have been reported.<sup>23,24</sup> Two published studies failed to demonstrate a clear benefit,<sup>25,26</sup> whereas preliminary results of another trial seem to indicate a possible improvement in DFS for patients who present with poor prognostic factors.<sup>27</sup> In addition, multiple HDCT may represent a new strategy for high-risk breast cancer patients,<sup>28</sup> and this interesting modality is actually under investigation in the adjuvant setting.<sup>29,30</sup>

In conclusion, the results of our study with multiple high-dose ICE chemotherapy and the relatively low toxicity observed in our patients indicate that this approach is suitable for patients who did not reach a pathological complete remission after neoadjuvant chemotherapy. The magnitude of the benefit from this treatment will be determined by randomized trials.

## REFERENCES

1. Bonadonna G, Veronesi U, Brambilla C, et al. Primary chemotherapy to avoid mastectomy in tumors with diameters of three centimeters or more. *J Natl Cancer Inst* 82:1539–1545, 1990.
2. Schwartz GF, Birchansky CA, Komarnicky LY, et al. Induction chemotherapy followed by breast conservation for locally advanced carcinoma of the breast. *Cancer* 73:362–369, 1994.
3. Veronesi U, Bonadonna G, Zurrida S, et al. Conservation surgery after primary chemotherapy in large carcinomas of the breast. *Ann Surg* 222:612–618, 1995.
4. Ferriere JP, Assier Cure H, Charrier S, et al. Primary chemotherapy in breast cancer: correlation between tumor response and patient outcome. *Am J Clin Oncol* 21:117–120, 1998.
5. Fisher B, Bryant J, Wolmark N, et al. Effect of preoperative chemotherapy on the outcome of women with operable breast cancer. *J Clin Oncol* 16:2672–2685, 1998.
6. Booser DJ, Hortobagyi GN. Anthracycline antibiotics in cancer therapy: focus on drug resistance. *Drugs* 47:223–258, 1994.
7. Lehnert M. Chemotherapy resistance in breast cancer. *Anticancer Res* 18:2225–2226, 1998.
8. Wood W, Budman D, Korzun A, et al. Dose and dose intensity of adjuvant chemotherapy for stage II, node positive breast carcinoma. *N Engl J Med* 330:1253–1259, 1994.
9. Frei E III, Canellos GP. Dose, a critical factor in cancer chemotherapy. *Am J Med* 69:585–594, 1980.
10. Hryniuk WM, Bush H. The importance of dose intensity in chemotherapy of metastatic breast cancer [review]. *J Clin Oncol* 2:1281–1287, 1984.
11. Henderson IC, Hayes DF, Gelman R. Dose-response in the treatment of breast cancer: a critical review. *J Clin Oncol* 6:1501–1515, 1988.
12. Budman DR, Berry DA, Cirincione C, et al. Dose and dose intensity as determinants of outcome in the adjuvant treatment of breast cancer. The Cancer and Leukemia Group B. *J Natl Cancer Inst* 90:1205–1211, 1998.
13. Fields KK, Elfenbein GJ, Lazarus HM, et al. Maximum-tolerated doses of ifosfamide, carboplatin, and etoposide given over 6 days followed by autologous stem-cell rescue: toxicity profile. *J Clin Oncol* 13:323–332, 1995.
14. Perkins J, Fields KK, Elfenbein GJ. Ifosfamide/carboplatin/etoposide chemotherapy for metastatic breast cancer with or without autologous hematopoietic stem cell transplantation: evaluation of dose-response relationships. *Semin Oncol* 22 (3 Suppl 7):58, 1995.
15. Fields KK, Zorsky PE, Hiemenz JW, Kronish LE, Elfenbein GJ. Ifosfamide, carboplatin, and etoposide: a new regimen with a broad spectrum of activity. *J Clin Oncol* 12:544–552, 1994.
16. Kling KM, Ostrzega N, Schmit P. Breast conservation after induction chemotherapy for locally advanced breast cancer. *Am Surg* 63:861–864, 1997.
17. Piccart M, Kerger J, Tomiack E, Perrault DJ. Systemic treatment for locally advanced breast cancer: what we still need to learn after a decade of multimodality clinical trials. *Eur J Cancer* 28:667–672, 1992.
18. Hortobagyi G, Singletary S, McNeese M. Treatment of locally advanced and inflammatory breast cancer. In: Harris J, Lippman M, Morrow M, et al., eds. *Disease of the Breast*. Philadelphia, PA: Lippincott-Raven, 1996, p. 585.

19. Andersson M, Madsen EL, Overgaard M, Rose C, Dombernowsky P, Mouridsen HT. Doxorubicin versus methotrexate both combined with cyclophosphamide, 5-fluorouracil and tamoxifen in postmenopausal patients with advanced breast cancer: a randomised-study with more than 10 years follow-up from the Danish Breast Cancer Cooperative Group. *Eur J Cancer* 35:39–46, 1999.
20. Marty M, Extra JM, Cottu PH, Espie M. Prospects with docetaxel in treatment of patients with breast cancer. *Eur J Cancer* 33:S26–S29, 1997.
21. Di Leo A, Crown J, Nogeret JM. Sequential adriamycin, docetaxel and CMF in the adjuvant treatment of breast cancer. *Eur J Cancer* 33:83, 1997.
22. Crown J, O’Leary M. The taxanes: an update. *Lancet* 355:1176–1178, 2000.
23. Hortobagyi GN, Buzdar AU, Champlin R, et al. Lack of efficacy of adjuvant high-dose tandem combination for high-risk primary breast cancer: a randomized trial [abstract]. *Proc ASCO* 17:471, 1998.
24. Gianni AM, Siena S, Bregni M, et al. Efficacy, toxicity and applicability of high-dose sequential chemotherapy as adjuvant treatment in operable breast cancer with 10 or more axillary nodes: five-year results. *J Clin Oncol* 15:2312–2321, 1997.
25. Peters W, Rosner G, Vredenburg J, et al. A prospective, randomized comparison of two doses of combination alkylating agents as consolidation after CAF in high-risk primary breast cancer involving ten or more axillary lymph nodes: preliminary results of CALGB 9082/SWOG 9114/NCIC.MA-13 [abstract]. *Proc ASCO* 18:2, 1999.
26. Bergh J. Results from a randomized adjuvant breast cancer study with high dose chemotherapy with CTCb supported by autologous bone marrow stem cells versus dose-escalated and tailored FEC therapy [abstract]. *Proc ASCO* 18:3, 1999.
27. Rodenhuis S, Bontenbal M, Beex L, et al. Randomized phase III study of high-dose chemotherapy with cyclophosphamide, thiotepa and carboplatinum in operable breast cancer with 4 or more axillary lymph nodes [abstract]. *Proc ASCO* 19:286, 2000.
28. Bassler RL, To LB, Collins JP, et al. Multicycle high-dose chemotherapy and filgrastim-mobilized peripheral-blood progenitor cells in women with high-risk stage II or III breast cancer: five-year follow-up. *J Clin Oncol* 17:82–92, 1999.
29. Martinelli G, Cinieri S, Ferrucci P, et al. Multiple high-dose chemotherapy with docetaxel (T), epirubicin (E) and cyclophosphamide (C) (HD-TEC) for high risk breast cancer (HRBC): results of a phase II study. *Proc ASCO* 19:218, 2000.
30. Martinelli G, Cinieri S. The IBCSG experiences [abstract]. 2nd Milan Breast Cancer Conference. In press.

# High-Dose Chemotherapy in Breast Cancer: Current Status of Ongoing German Trials

*Nicolaus Kröger, William Krüger, Axel Rolf Zander*

*Bone Marrow Transplantation,  
University Hospital Hamburg-Eppendorf, Germany*

## BACKGROUND

Early trials of high-dose chemotherapy followed by autologous bone marrow transplantation suggested that this approach might have a major impact on the course of disease in breast cancer patients.<sup>1</sup> Despite the expansion of high-dose chemotherapy (HDCT) to breast cancer, few randomized studies comparing high-dose chemotherapy with standard chemotherapy have been performed to date. Two small randomized studies, with 81 and 78 patients, have been performed by M.D. Anderson<sup>2</sup> and by a Dutch group.<sup>3</sup> Neither trial observed a difference in overall or disease-free survival between high-dose and standard-dose chemotherapy. However, due to the small number of patients included, the statistical power of these studies was relatively low. At the American Society of Clinical Oncology (ASCO) meeting in 1999, 3 further studies were presented. One trial by Bezwoda from South Africa has been excluded because of severe irregularities.

In the Scandinavian trial, patients received either high-dose chemotherapy or accelerated-dose (tailored) anthracycline-containing standard chemotherapy (Table 1). This trial failed to show a survival benefit for high-dose chemotherapy, but patients in the standard arm did not receive a truly standard protocol—they received higher cumulative doses of alkylating agents and suffered a higher incidence of secondary leukemia.<sup>4</sup> In the Intergroup trial, high-risk stage II/III patients received FAC (fluorouracil, adriamycin, and cyclophosphamide) followed by HDCT (STAMP-1) or a intermediate dose of cyclophosphamide, carmustine, and cisplatin. After a short follow-up of 37 months, no difference in overall survival was observed, but the event-free survival was 68% in the HDCT group and 64% in the control arm. The higher relapse rate of the standard arm was counterbalanced by the high mortality (7%) of the high-dose regimen, probably due to BCNU-induced pulmonary toxicity.<sup>5</sup> A third Dutch study presented at the ASCO meeting in 2000 included >800 patients (with >4 involved lymph nodes), and an interim analysis of the first 284 was presented.<sup>6</sup> In this trial, after 4 cycles of FEC (fluorouracil, epirubicin, and cyclophosphamide) induction chemotherapy, patients were

randomized to receive another FEC cycle or HDCT (STAMP V [cyclophosphamide, thiotepa, and carboplatin]) followed by autologous stem cell support. At 3 years, event-free survival was 77% in HDCT and 62% in the control group ( $P=.009$ ). The overall survival showed a 10% difference in favor of HDCT. The final analysis of all 885 patients will be presented in 2002.

In metastatic disease, a study from South Africa showed a survival benefit for HDCT,<sup>7</sup> whereas in a small French study, HDCT was superior only in terms of time to progression compared with standard therapy (Table 2).<sup>8</sup> The Philadelphia Intergroup reported no difference in overall survival between patients with complete remission (CR)/partial remission (PR) after induction chemotherapy followed by 1 cycle of HDCT (STAMP V) and those patients with PR/CR after induction chemotherapy followed by up to 24 cycles CMF conventional therapy.<sup>9</sup>

There is still a need for longer follow-up and further studies to determine the true value of high-dose chemotherapy in breast cancer. Here we report on current German activities in randomized HDCT studies for breast cancer patients (Table 3).

### GERMAN ADJUVANT HIGH-DOSE CHEMOTHERAPY TRIAL

Currently, there are 2 large ongoing trials investigating the role of high-dose chemotherapy in adjuvant high-risk breast cancer (>9 involved lymph nodes). The trial of the German Adjuvant Breast Cancer Study Group (GABG-4/EH93) compares induction consisting of 4 cycles epirubicin (90 mg/m<sup>2</sup>) and cyclophosphamide (600 mg/m<sup>2</sup>) then HDCT (CTM: cyclophosphamide 6000 mg/m<sup>2</sup>, thiotepa 600 mg/m<sup>2</sup>, and mitoxantrone 40 mg/m<sup>2</sup>) followed by peripheral blood stem cell support with 3 cycles of standard-dose of CMF (cyclophosphamide, methotrexate, and fluorouracil). Blood stem cells are mobilized with granulocyte colony-stimulating factor.<sup>10</sup> The CTM high-dose protocol has been shown to be an

**Table 1.** Randomized High-Dose Chemotherapy Adjuvant Studies in Breast Cancer\*

Study	Reference	n	TRM, %		3-y EFS, %		3-y OS, %	
			HDCT	Standard	HDCT	Standard	HDCT	Standard
CALGB	4	783	7.4	0	71	64	79	79
Scandinavian	4	525	0.7	0	68	62	79	76
Dutch I	3	81	0	0	70	65	82	75
Dutch II	6	284	1	0	77	62†	89	79†
M.D. Anderson	2	78	2.5	0	48	55	60	68

\*CALGB, Cancer and Leukemia Group B; EFS, event-free survival; HDCT, high-dose chemotherapy; OS, overall survival; TRM, treatment-related mortality. †Statistically significant difference.

**Table 2.** Randomized High-Dose Chemotherapy Studies in Metastatic Breast Cancer\*

Study	Reference	n	TRM, %		3-y EFS, %		3-y OS, %	
			HDCT	Standard	HDCT	Standard	HDCT	Standard
Philadelphia	9	184	1	0	6	12	32	38
South Africa	7	90	0	0	18	4†	18	4†
French	8	61	0	0	49	21	55	28

\*EFS, event-free survival; HDCT, high-dose chemotherapy; OS, overall survival; TRM, treatment-related mortality. †Statistically significant difference.

effective conditioning regimen with less toxicity.<sup>11</sup> Up to the summer of 2000, 310 patients had been randomized, with an expected accrual of 320 patients. The study was to be closed in the autumn of 2000, and the first results will be presented in mid-2001. An interim analysis showed a manageable toxicity and a treatment-related mortality of <2%.<sup>12</sup> The impact of tumor cell contamination of the bone marrow and the apheresis product will be presented at the final analysis.<sup>13</sup> Further purging strategies are focusing on immunological elimination of tumor cells from leukapheresis products with bispecific monoclonal antibodies.

A second study from the Westdeutsche Study Group (WSG) enrolls patients with >10 involved lymph nodes. After 2 cycles of dose-intensified epirubicin (90 mg/m<sup>2</sup>) and cyclophosphamide (600 mg/m<sup>2</sup>) with a 14-day interval, patients were randomized to 2 cycles of high-dose chemotherapy consisting of epirubicin (90 mg/m<sup>2</sup>), cyclophosphamide (3000 mg/m<sup>2</sup>), and thiotepa (440 mg/m<sup>2</sup>) or to standard therapy consisting of 4 cycles of epirubicin/cyclophosphamide followed by 3 cycles of CMF. To date, 335 patients are randomized, and an accrual of 400 was expected at the end of 2000. No treatment-related mortality has been observed in this study.

### GERMAN HIGH-DOSE CHEMOTHERAPY TRIAL IN METASTATIC BREAST CANCER

To investigate the question whether 2 cycles of HDCT are better than 1, the Hamburg group (GABG) and WSG conducted a randomized trial for patients with metastatic breast cancer and PR or CR after 6 cycles of induction chemotherapy. These patients will be randomized to either 1 or 2 cycles of HDCT according to the STAMP V protocol. Two hundred patients have been randomized, with an expected accrual of 320. A second study by the GEBDIS (German Breast Cancer Dose Intensity Study) randomizes patients with metastatic breast cancer after 3 cycles of induction chemotherapy to tandem HDCT (ICE [ifosfamide, carboplatin, and etoposide] and cyclophosphamide/thiotepa) or 3 further cycles of

**Table 3.** Ongoing German Adjuvant High-Dose Chemotherapy Trials in Breast Cancer\*

Study	Patients	Needed	Induction	Randomization	Results
GABG-4/EH93	310†	320	4× EC	HDCT (CTM) vs. 3× CMF	2001
WSG	335†	400	2× EC	2× HDCT (ECT) vs. 4× EC→3× CMF	2001
Hamburg/WSG	180‡	320	Max. 6× standard	1× HDCT (STAMP V) vs. 2× HDCT (STAMP V)	2002
GEBDIS	160‡	320	3× ADM/ docetaxel	2× HDCT (ICE + cyclophosphamide/thiotepa) vs. 3× ADM/docetaxel	2002
Berlin	79‡	400	None	2× HDCT (CNV) vs. 6× ADM/docetaxel	2001§

\*ADM, adriamycin; CMF, cyclophosphamide, methotrexate, fluorouracil; CNV, cyclophosphamide, mitoxantrone, vincristine; CTM, cyclophosphamide, thiotepa, mitoxantrone; EC, epirubicin, cyclophosphamide; ECT, cisplatin, epirubicin, raltitrexed; GABG-4, German Adjuvant Breast Cancer Study Group; GEBDIS, German Breast Cancer Dose Intensity Study; HDCT, high-dose chemotherapy; ICE, ifosfamide, carboplatin, etoposide; STAMP V, cyclophosphamide, thiotepa, and carboplatin; WSG, Westdeutsche Study Group.  
†Enrolled; ‡randomized; §interim.

standard chemotherapy consisting of adriamycin and docetaxel. One hundred sixty patients have been randomized, and 320 are planned.<sup>14</sup> Two treatment-related deaths were observed (<2%). A third study from Berlin compares up-front tandem high-dose chemotherapy (CNV [cyclophosphamide, mitoxantrone, and vincristine]) according to the Bezwoda scheme with 6 cycles of standard chemotherapy consisting of adriamycin and paclitaxel. Seventy-nine of planned 400 patients have been randomized.

Despite the decreasing accrual of patients since the 1999 ASCO meeting, the German randomized trial will be completed within the next year and should help address the question of the true value of high-dose chemotherapy in breast cancer.

## REFERENCES

1. Peters WP, Ross M, Vredenburg J, et al. High-dose chemotherapy and autologous bone marrow support as consolidation after standard dose adjuvant therapy for high-risk primary breast cancer. *J Clin Oncol* 11:1132–1143, 1993.
2. Hortogagi GN, Buzdar AU, Champlin R, et al. Lack of efficacy of adjuvant high-dose tandem combination chemotherapy for high-risk primary breast cancer: a randomized trial [abstract]. *Proc ASCO* 17:123a, 1999.
3. Rodenhuis S, Richel KJ, Wall EVD, et al. Randomized trial of high-dose chemotherapy and hematopoietic progenitor cell support in operable breast cancer with extensive axillary lymph node involvement. *Lancet* 352:515–521, 1998.



4. Bergh J, TSBCS Group. Results from a randomized adjuvant breast cancer study with high-dose chemotherapy with CTCb supported by autologous bone marrow stem cells versus dose escalated and tailored FEC therapy [abstract]. *Proc ASCO* 18:2a, 1999.
5. Peters W, Rosner G, Vredenburg J, et al. A prospective, randomized comparison of two doses of alkylating agents as consolidation after CAF in high risk primary breast cancer involving ten or more axillary lymph nodes: preliminary results of CALB 9082/SWOG 9114/ NCIC MA-13 [abstract]. *Proc ASCO* 18:1a, 1999.
6. Rodenhuis S, Bontenbal M, Beex L, et al. Randomized phase III study of high-dose chemotherapy with cyclophosphamide, thiotepa and carboplatin in operable breast cancer with 4 or more axillary lymph nodes [abstract]. *Proc ASCO* 19:286, 2000.
7. Bezwoda WR, Seymour L, Dansey RD. High-dose chemotherapy with hematopoietic rescue as primary treatment for metastatic breast cancer: a randomised trial. *J Clin Oncol* 13:2483–2487, 1995.
8. Lotz JP, Cure H, Janvier M, et al. High-dose chemotherapy with hematopoietic stem cell transplantation for metastatic breast cancer: results of the French protocol PEGASE IV [abstract]. *Proc ASCO* 18:43a, 1999.
9. Stadtmayer EA, O'Neill A, Goldstein LJ, et al. Conventional-dose chemotherapy compared with high-dose chemotherapy plus autologous hematopoietic stem cell transplantation for metastatic breast cancer. *N Engl J Med* 342:1069–1076, 2000.
10. Kröger N, Zeller W, Hassan HT, et al. Stem cell mobilization with G-CSF alone in breast cancer patients: higher progenitor cell yield by delivering divided doses ( $2 \times 5 \mu\text{g}/\text{kg}$ ) compared to single dose ( $1 \times 10 \mu\text{g}/\text{kg}$ ). *Bone Marrow Transplant* 23:125–129, 1999.
11. Damon LE, Wolf JL, Rugo HS, et al. High-dose chemotherapy (CTM) for breast cancer. *Bone Marrow Transplant* 26:257–268, 2000.
12. Zander AR, Krüger W, Kröger N, et al. High-dose mitoxantrone with thiotepa, cyclophosphamide and autologous stem cell rescue for high risk stage II and III breast cancer. German GABG-4/EH-93 study. *Bone Marrow Transplant* 18 (Suppl 1):24–25, 1996.
13. Krüger W, Krzizanowski C, Holweg M, et al. Reverse transcriptase/polymerase chain reaction detection of cytokeratin-19 mRNA in bone marrow and blood of breast cancer patients. *J Cancer Res Clin Oncol* 122:679–686, 1996.
14. Kröger N, Frick M, Nitz U, Zander AR. Ongoing prospective, randomized trial of single versus tandem high-dose chemotherapy (CTC) in patients with metastatic breast cancer responding to conventional chemotherapy with partial or complete remission. *Bone Marrow Transplant* 22 (Suppl 2):S14–S15, 1998.

# Intermediate High-Dose Chemotherapy in Metastatic Breast Cancer

*Karel A. Dicke*

*Arlington Cancer Center, Arlington, Texas*

## INTRODUCTION

The prognosis of metastatic breast cancer with conventional chemotherapy is poor; median survival of 19 months and <5% 5-year survival have been reported.<sup>1,2</sup> The use of higher doses of chemotherapy has increased response rates; survival, however, has hardly been influenced.<sup>3</sup> Since the mid-1980s, several intensive-dose chemotherapy protocols with hematopoietic stem cell rescue have been initiated; 5-year disease-free survival rates of 20% were reported, whereas the median survival did not change significantly.<sup>4</sup> In those series, the relapse rate was up to 80%, with the majority of relapses occurring within 2 years after high-dose therapy. We initiated, 7 years ago, a program in metastatic disease of aggressive standard-dose chemotherapy of 3 different non-cross-resistant chemotherapy protocols followed by intensive chemotherapy consisting of 3 different protocols over a period of 2 years. The results of 100 patients are presented.

## MATERIALS AND METHODS

Informed consent of Institutional Review Board-approved protocols was obtained. One hundred patients with metastatic breast cancer were treated with standard-dose chemotherapy consisting of 3 consecutive non-cross-resistant protocols: 3 to 6 courses of CAVe (cyclophosphamide, adriamycin, and VP-16), 3 to 6 courses of adriamycin/vinblastine (Velban), and 2 to 4 courses of FuMEP (fluorouracil, mitomycin, VP-16, and cisplatin [Platinol]) with a median duration of 12 months. After that, 2 schemas of treatment were used. Schema A consisted of a 2-year intensive program with CVP (cyclophosphamide [Cytosan] 2 g/m<sup>2</sup>, VP-16 600 mg/m<sup>2</sup>, and cisplatin 90 mg/m<sup>2</sup>) alternated with TIP (paclitaxel [Taxol] 300 mg/m<sup>2</sup>, ifosfamide 7.5 g/m<sup>2</sup>, and cisplatin 90 mg/m<sup>2</sup>) with a 5-week interval between the first 2 courses, followed by a 2- to 3-month interval for 2 years. The last course was followed by MTB (mitoxantrone 30 mg/m<sup>2</sup>, thiotepa 300 mg/m<sup>2</sup>, and BCNU 300 mg/m<sup>2</sup>) with bone marrow support. Later, schema B was initiated and consisted of 1 course of CVP and TIP followed by 1 course of MTB with peripheral

blood stem cell support; the interval between courses was 5–6 weeks. After that, a 2-year maintenance chemotherapy program was used consisting of standard-dose chemotherapy. The interval between courses was 6–8 weeks. In schema A, bone marrow support was used at the end of the program because hematopoietic recovery was relatively slow and often incomplete. In contrast, with the availability of mobilized peripheral blood cells, after which hematopoietic recovery was fast and complete, patients could tolerate further chemotherapy; therefore, the MTB protocol was used earlier and followed by maintenance chemotherapy. Because the number of patients is small, results of schemas A and B are combined. The program is done on an outpatient basis; when the white blood cell count (WBC) was  $<2000/\text{mm}^3$ , prophylactic intravenous antibiotics were started and continued until the count was  $>2000/\text{mm}^3$ . Less than 10% of the courses were complicated by infections necessitating hospital admission. Collection of bone marrow and peripheral blood stem cells, storage of cells, and infusion of cells have been reported elsewhere.<sup>5,6,7</sup> The total treatment program of stage IV breast cancer has been documented in Table 1.

Responses were measured by progression-free survival estimates. Also, overall survival was determined as response to treatment, because progression of disease was determined as early as possible by using the cytokeratin assay measuring small numbers of breast cancer cells in the marrow and peripheral blood<sup>8</sup> as well as by changes in tumor markers in the serum without radiographic changes.

## RESULTS

Patients were divided into 3 groups according to tumor load and response to aggressive standard-dose chemotherapy, as outlined in Table 2.

Patients in category A respond to chemotherapy with minimal residual disease, category B patients respond to chemotherapy but still have measurable disease after treatment, and category C patients have progression of disease during and after standard-dose chemotherapy. Progression-free survival (PFS) of 21 patients in category A is shown in Figure 1. The median PFS is 34 months; 10 of 21 patients relapsed; the overall survival of these 10 patients is shown in Figure 2. It appears that their survival is not different from the overall survival of the entire category A patient population, 90%, with a median follow-up of 3 years (Figure 3). This is in contrast to the survival rate of the category B population (Figure 4): a median

**Table 1.** Total Treatment Program of Stage IV Breast Cancer in Arlington Cancer Center

- 
- Multiple doses of 2 or more aggressive, non-cross-resistant, normal-dose regimens
  - Involved-field radiation and/or surgery
  - High-dose therapy
  - Posttransplant therapy for 2 years
-

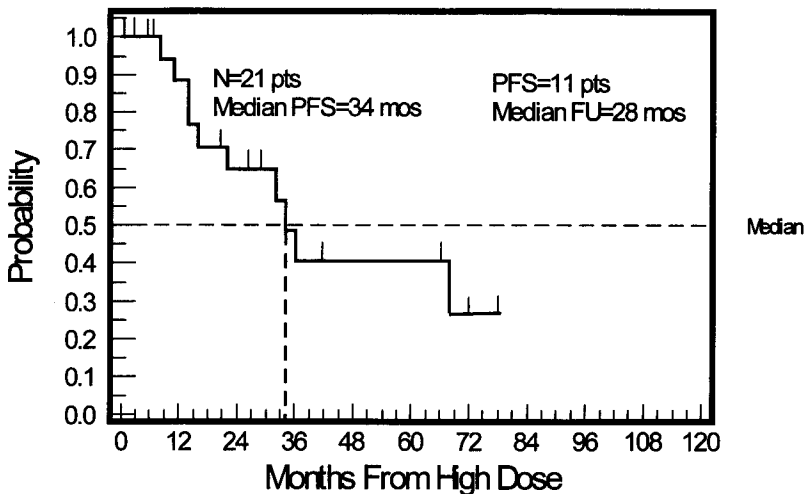
**Table 2.** Stage IV Patient Groups According to Tumor Load and Response to Aggressive Standard-Dose Chemotherapy

Category	Patients
A	Minimal residual disease
B	Chemotherapy-responsive but with measurable residual disease
C	Progression of disease after aggressive standard-dose chemotherapy

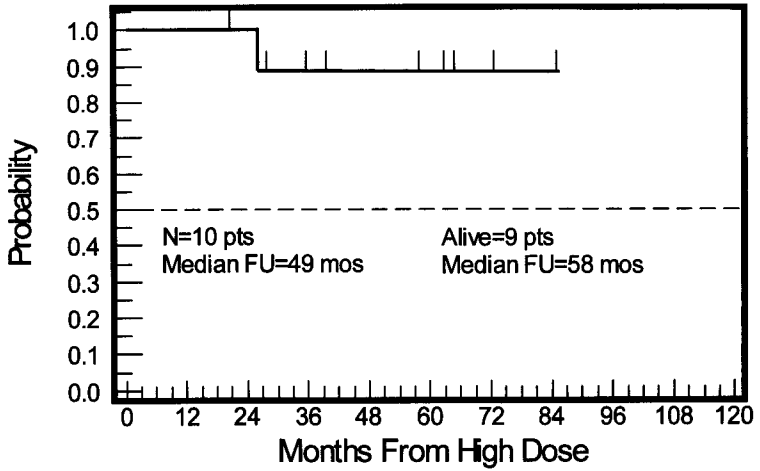
survival of 30 months. Thirteen of the 36 patients in category B are alive, of whom 5 are alive >5 years. The survival results of category A, B, and C patients have been plotted in Figure 5. Note the difference in survival, the longest in category A and the shortest in category C, with a median survival of 12 months.

## DISCUSSION

It is clear from the results that patients with disease completely responding to standard-dose chemotherapy do better than patients with a partial response and those with progression of disease. This is consistent with results and the concept published by Philip et al.<sup>9</sup> The overall survival of the 100 patients is 42 months, which is superior to the median survival of 19 months of metastatic breast cancer patients in the Cancer and Leukemia Group B (CALGB) study as published by Mick et al.<sup>2</sup> Patient selection cannot be excluded as a factor and may account for the favorable results. Our program

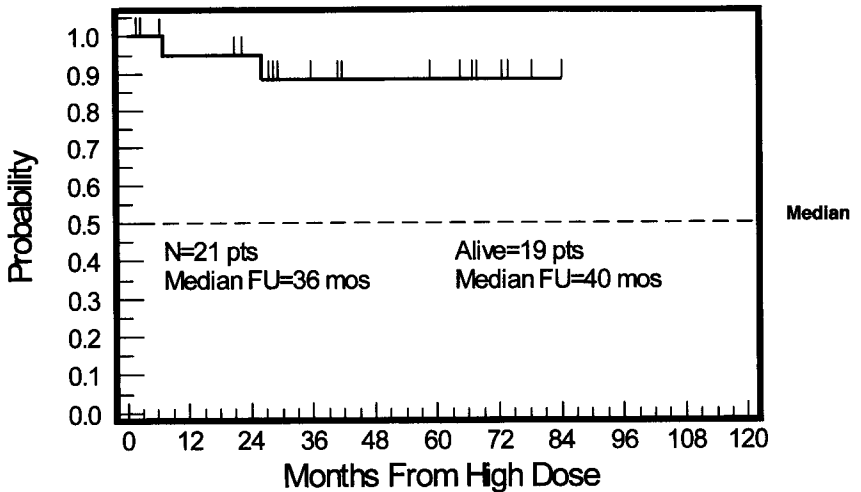


**Figure 1.** Stage IV breast cancer, category A. FU, follow-up; PFS, progression-free survival.

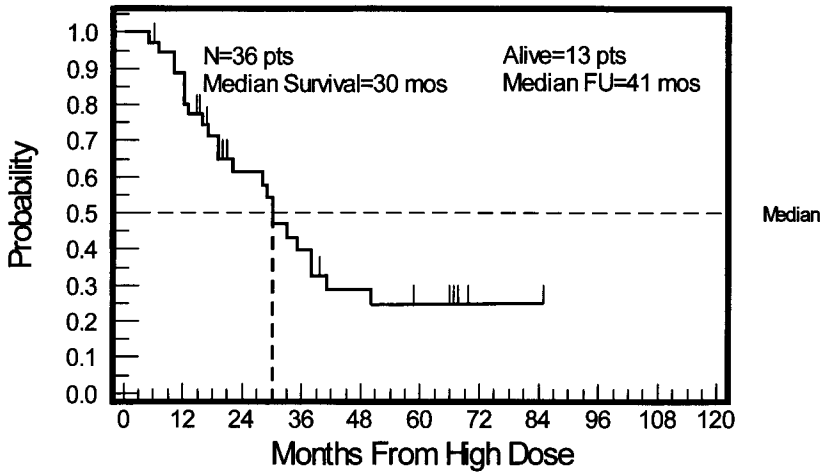


**Figure 2.** Stage IV breast cancer, category A. Overall survival of relapsed patients. FU, follow-up.

is totally outpatient based and therefore patient-friendly and cost-effective. The frequency of infectious episodes that necessitate hospitalization is <10%. The program with 3 courses of high-dose followed by maintenance (schema B) is more patient-friendly than schema A, in which intensive chemotherapy regimens, CVP and TIP, are alternated for 2 years. The maintenance program does not interfere with day-to-day life,

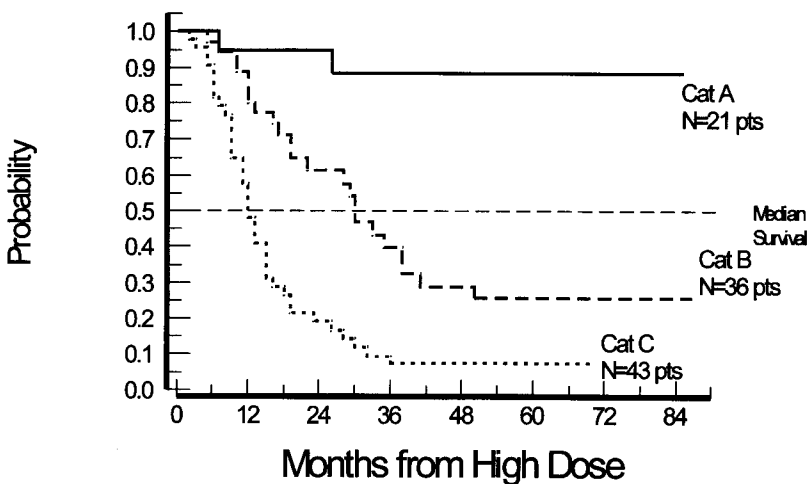


**Figure 3.** Stage IV Breast Cancer, category A. Overall survival. FU, follow-up.



**Figure 4.** Stage IV breast cancer, category B. Overall survival. FU, follow-up.

which is not the case in schema A; the CVP and TIP protocols are aggressive, cause severe neutropenia, and tie the patients to Arlington for 3-week periods. The difference in hematopoietic recovery between bone marrow and peripheral blood stem cells is striking: 2–3 times more stem cells could be harvested from the peripheral blood; not only was hematopoietic recovery hastened, but also the recovery was complete in that



**Figure 5.** Stage IV breast cancer, categories (Cat) A, B, and C. Difference in survival after high-dose therapy.

WBCs as well as platelet counts normalized. These patients tolerated maintenance chemotherapy very well, without major neutropenia or thrombocytopenia.

We have incorporated the use of herceptin in the maintenance program in schema B. It is difficult in our treatment design to establish the role of herceptin as a single agent, rather than the efficacy of a combination of this drug with single-agent chemotherapy.

Key to prevention of major progression in patients is treatment of minimal disease. This is possible with the help of sensitive detection methods such as the cytokeratin assay as well as serological tumor markers. With these methods, small numbers of tumor cells can be detected without significant changes on computed tomography scans, magnetic resonance imaging, or bone scan.

## REFERENCES

1. Clark G, Sledge GW, Osborne CK, McGuire WL. Survival from first recurrence: relative importance of prognostic factors in 1,015 breast cancer patients. *J Clin Oncol* 5:55–61, 1987.
2. Mick R, Begg CB, Antman K, Korzun AH, Frei E III. Diverse prognosis in metastatic breast cancer: who should be offered alternative initial therapies? *Breast Cancer Res Treat* 13:33–38, 1989.
3. Spitzer G, Deisseroth A, Ventura G, et al. Use of recombinant human hematopoietic growth factors and autologous bone marrow transplantation attenuate the neutropenic trough of high-dose therapy. *Int J Cell Cloning* 1:249–261, 1990.
4. Dunphy FR, Spitzer G, Buzdar AU, et al. Treatment of estrogen receptor-negative or hormonally refractory breast cancer with double high-dose chemotherapy intensification and bone marrow support. *J Clin Oncol* 8:1207–1216, 1990.
5. Dicke KA, Hood DL, Hanks S, et al. A marrow harvest procedure under local anesthesia. *Exp Hematol* 23:1229–1232, 1995.
6. Dicke KA, Hood DL, Donnell PJ, et al. Large volume leukapheresis alters the kinetics of progenitor cells mobilization [abstract]. 26<sup>th</sup> Annual Meeting of ISEH, August 24–28, Cannes France. *Exp Hematol* 25:282a, 1997.
7. Dicke KA, Hood DL, Hanks S, et al. Stem cell reinfusion over two consecutive days + delayed G-CSF hastens engraftment [abstract]. Ninth International Symposium on Autologous Blood and Marrow Transplantation. Dallas, TX, July 27–30, 1998.
8. Hood DL, Dicke KA, Donnell PJ, Sowell LK, Fulbright LK. Cytokeratin labeling with flow cytometry analysis to detect minimal disease in the marrow and blood of breast and lung cancer patients [abstract]. Tandem BMT Meeting, Keystone, CO, February 28–March 3, 1999.
9. Philip T, Armitage JO, Spitzer G, et al. High-dose therapy and autologous bone marrow transplantation after failure of conventional chemotherapy in adults with intermediate-grade or high-grade non-Hodgkin's lymphoma. *N Engl J Med* 316:1493–1498, 1987.

# High-Dose Chemotherapy as an Integrated Program With Normal-Dose Chemotherapy and Irradiation in Poor-Prognosis Primary Breast Cancer

*Karel A. Dicke, George R. Blumenschein*

*Arlington Cancer Center, Arlington, Texas*

The treatment of stage IIB (>9 positive lymph nodes), IIIA, and IIIB breast cancer with conventional-dose chemotherapy, surgery, and irradiation has resulted in a 45% disease-free survival (DFS) at 5 years.<sup>1</sup> The reason that 55% of patients relapse is most likely the failure to eliminate all of the microscopic tumor burden, which may contain drug-resistant clones of breast cancer. Recently, Blumenschein et al.<sup>2</sup> studied a non-cross-resistant combination of drugs following treatment of stage IIB, IIIA, and IIIB breast cancer. After or before mastectomy, the patients received 6 courses of a doxorubicin combination, followed by irradiation, and then a cyclophosphamide (Cytosan)/methotrexate/fluorouracil/dexamethasone plus cisplatin combination (McCFUD). This resulted in a 62% DFS rate at 7 years.<sup>2</sup> The late relapses observed provided a reason to initiate a study to add high-dose chemotherapy to this treatment regimen. We were encouraged by the 74% 4-year DFS rate in poor-prognosis breast cancer published by Peters et al.<sup>3</sup> We report here the results of 40 patients treated with high-dose chemotherapy in conjunction with the Blumenschein treatment regimen.

## METHODS

Forty patients diagnosed with stage IIB (>9 positive lymph nodes), IIIA, and IIIB breast cancer were entered in the study for 1992–1999 as approved by the Arlington Cancer Center Institutional Review Board. Patient characteristics are depicted in Table 1.

Generally, stage IIB and IIIA patients were seen after mastectomy and started on chemotherapy. Stage IIIB patients were started on chemotherapy and had mastectomy after receiving 2 or 3 courses of induction chemotherapy. The initial program consisted of CAVe (cyclophosphamide 500 mg/m<sup>2</sup> intravenously [IV] on day 1, VP-16 80 mg/m<sup>2</sup> IV on days 1, 2, and 3, and adriamycin 50 mg/m<sup>2</sup> continuous infusion over 72 hours). After 6 courses of CAVe, the patients received radiation therapy to the chest wall and peripheral lymphatics; they then started on McCFUD therapy for 3 courses. McCFUD consisted of methotrexate 120 mg/m<sup>2</sup>,



**Table 1.** Adjuvant Patient Characteristics\*

Number of patients	40
Median age, y	46
ER/PR <sup>+</sup>	26 (2 unknown)
Her-2/neu <sup>+</sup>	7/20 (20 unknown)
Tumor status	Stage II >10 LN <sup>+</sup> Stage IIIA, IIIB

\*ER, estrogen receptor; LN, lymph node; PR, progesterone receptor.

decadron 10 mg IV every 6 hours  $\times$  8 doses, fluorouracil 1000 mg/m<sup>2</sup> IV over 1 hour 6 hours after methotrexate, cisplatin 60 mg/m<sup>2</sup> on day 2, leucovorin 15 mg po every 6 hours  $\times$  8 doses starting 24 hours after methotrexate, and cyclophosphamide 300 mg/m<sup>2</sup> continuous infusion from day 3 to day 5. After finishing the McCFUD protocol, patients started the high-dose (HD) program. This consisted of 1 course of CVP (cyclophosphamide, VP-16, and cisplatin) followed 5 weeks later by a course of TIP (paclitaxel, ifosfamide, and cisplatin) as depicted in Table 2.

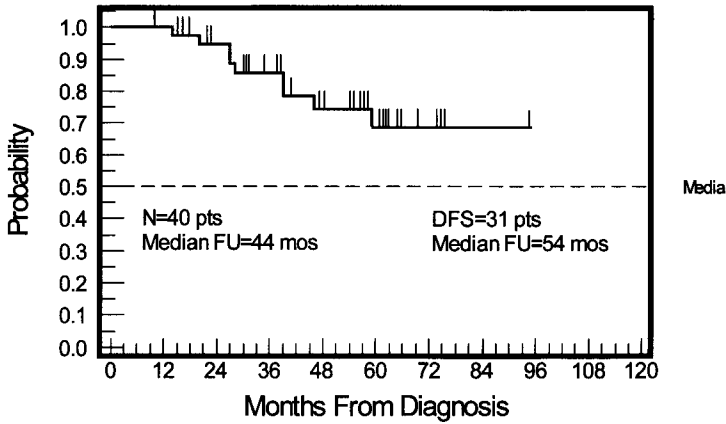
These regimens are dose-intensive, nonmyeloablative, and growth factor-dependent but not dependent on stem cell support.

## RESULTS

Figure 1 presents DFS from diagnosis. The projected 5-year DFS is 70%. Thirty-one patients are still disease-free, with a median follow-up of 54 months. We studied the effect of Her-2/neu positivity on DFS. Of the 20 patients tested, 7 were positive, whereas 13 were negative (Table 3). It can be noted in Table 3 that only 2 patients who were Her-2/neu-negative relapsed, whereas 4 of the 7 positive patients relapsed. A Kaplan-Meier survival estimate of Her-2/neu<sup>+</sup> and Her-2/neu<sup>-</sup> patients is depicted in Figure 2.

**Table 2.** The High-Dose Program in Adjuvant Bad-Prognosis Breast Cancer

	Level I Intensity
CVP	
Cyclophosphamide, g/m <sup>2</sup>	2-3
VP-16, mg/m <sup>2</sup>	600-750
Cisplatin, mg/m <sup>2</sup>	90
TIP	
Paclitaxel, mg/m <sup>2</sup>	300
Ifosfamide, g/m <sup>2</sup>	7.5-9
Cisplatin, mg/m <sup>2</sup>	90



**Figure 1.** Disease-free survival (DFS). FU, follow-up; pt, patient.

## DISCUSSION

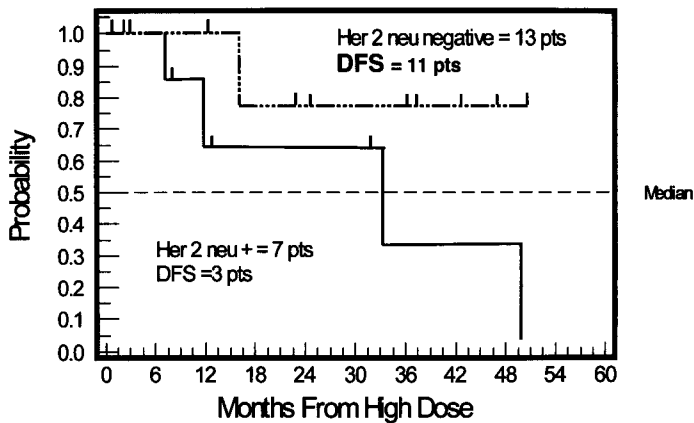
The addition of HD to the Blumenschein aggressive normal-dose program does not increase the 5-year DFS of 70% but may extend the rate to 8 years. Longer-term follow-up is needed to confirm this statement. The treatment-related mortality is 0%, and quality of life is excellent. Long-term side effects were observed in 1 patient with hemorrhagic cystitis after ifosfamide.

Our results confirm the data of Peters et al.<sup>3</sup> in that patients treated with an intermediate high-dose regimen had a 5-year DFS rate similar to that of patients treated with stem cell–dependent doses.<sup>4</sup> In the study of Peters et al., however, the mortality rate in the stem cell–dependent dose arm was 7%, which may account for the lack of difference between the 2 arms. The use of stem cells may introduce additional malignant cells from the graft into the recipient. The risk of relapse due to infused malignant cells is a realistic danger unless sensitive detection tests identify the presence of malignant cells in the apheresis product before infusion. Such tests have been developed by us and others.<sup>5,6</sup>

**Table 3.** Influence of Her-2/neu on Disease-Free Survival (DFS) ( $n = 20$ )\*

	Her-2/neu <sup>+</sup>	Her-2/neu <sup>-</sup>
<i>n</i>	7	13
DFS	3	11
Relapse	4	2

\*The data confirm results of DeAraujo,<sup>7</sup> lower DFS rate in Her-2/neu<sup>+</sup> patients.



**Figure 2.** Survival according to Her-2/neu status. DFS, disease-free survival; pt, patient.

Overexpression of Her-2/neu is a bad prognostic factor, and Her-2/neu<sup>+</sup> patients with breast cancer have a shorter DFS after HD and stem cell support, as reported by DeAraujo.<sup>7</sup> The introduction of Herceptin as part of the overall treatment plan is investigated to limit relapses in patients who have Her-2/neu<sup>+</sup> disease.

## REFERENCES

1. Blumenschein GR. Use of noncross-resistant chemotherapy in combination with irradiation and surgery for treatment of regionally advanced primary breast cancer. In: Dicke KA, Keating A, eds. *Autologous Blood and Marrow Transplantation: Proceedings of the Eighth International Symposium, Arlington, Texas*. Charlottesville, VA: Carden Jennings, 1997, p. 253–258.
2. Blumenschein GR, DiStefano A, Caderao JC, et al. Multimodality therapy for locally advanced and limited stage IV breast cancer: the impact of effective noncross-resistant late consolidation chemotherapy. *Clin Cancer Res* 3:2633–2637, 1997.
3. Peters WP, Ross M, Vredenburgh JJ, et al. High-dose chemotherapy and autologous bone marrow support as consolidation after standard-dose adjuvant therapy for high-risk primary breast cancer. *J Clin Oncol* 11:1132–1143, 1993.
4. Peters W, Roser G, Vredenburgh J, et al. A prospective, randomized comparison of two doses of combination alkylating agents (AA) as consolidation after CAF in high-risk primary breast cancer involving ten or more axillary lymph nodes (LN): preliminary results of CALGB 9082/SWOG 9114/NCIC MA-13. *Proc ASCO* 18:1a, 1999. Abstract 2.
5. Ross AA, Layton TJ, Stenzel-Johnson P, et al. Enrichment of tumor cells from autologous transplantation grafts from breast cancer patients. In: Dicke KA, Keating A, eds. *Autologous Blood and Marrow Transplantation: Proceedings of the Ninth International Symposium, Arlington, Texas*. Charlottesville, VA: Carden Jennings, 1999, p. 521–528.

6. Hood DL, Dicke KA, Donnell PJ, Fulbright LK, Blumenschein GR. Detection of cyto-keratin<sup>+</sup> cells in marrow as a predictor for tumor cell contamination and measurement of tumor cell loss in apheresis products. In: Dicke KA, Keating A, eds. *Autologous Blood and Marrow Transplantation: Proceedings of the Ninth International Symposium, Arlington, Texas*. Charlottesville, VA: Carden Jennings, 1999, p. 256–264.
7. DeAraujo C, Bitran J, Testingi T, et al. Follow-up on HER2/NEU overexpression as a negative prognostic factor in women with stage II/III high risk (>10 involved nodes) breast cancer treated with autologous bone marrow transplantation (ABMT) [abstract]. *Proc ASCO* 18:44a, 1999. Abstract 166.

# **Studies With the High-Dose Chemotherapy Regimen CTC (Cyclophosphamide, Thiotepa, and Carboplatin) in Breast Cancer**

***Sjoerd Rodenhuis, Elisabeth G.E. de Vries, Jos H. Beijnen***

*Division of Medical Oncology (S.R.), The Netherlands Cancer Institute,  
Amsterdam; Department of Medical Oncology (E.G.E.d.V.),  
Groningen University Hospital, Groningen; Department of Pharmacy (J.H.B.),  
The Netherlands Cancer Institute and Slotervaart Hospital,  
Amsterdam, The Netherlands*

## **ABSTRACT**

The high-dose chemotherapy regimen CTC incorporates cyclophosphamide 6 g/m<sup>2</sup>, thiotepa 480 mg/m<sup>2</sup>, and carboplatin 1600 mg/m<sup>2</sup>. CTC is related to the frequently used CTCb regimen, but contains twice as much carboplatin and is administered in short-term infusions over 4 days rather than as a continuous infusion. The regimen has been used extensively in the Netherlands, mainly in breast cancer and germ cell cancer.

CTC has been employed in 2 randomized studies of high-dose chemotherapy in breast cancer. The first was a randomized phase 2 single-center study in 81 patients that did not show a (relapse-free) survival benefit for the high-dose arm. The second trial was a randomized phase 3 study in 885 patients with 4 or more axillary lymph node metastases. A preliminary analysis of this study revealed a non-significant trend toward improved recurrence-free survival ( $P=.057$ ) for the high-dose regimen. A more definitive analysis is expected in 2002.

## **INTRODUCTION**

A variety of high-dose chemotherapy regimens have been used in the treatment of solid tumors.<sup>1</sup> For breast cancer, the STAMP-I and STAMP-V regimens have received most attention. The STAMP-I (or CPB) regimen contains cyclophosphamide, BCNU, and cisplatin. Its use has been described in several key publications by Peters and colleagues, including the study showing that a single course of STAMP-I may result in long-term disease-free survival in some patients with advanced breast cancer<sup>2</sup> and the uncontrolled study of high-dose

chemotherapy in primary breast cancer with 10 or more positive axillary lymph nodes.<sup>3</sup> The CPB regimen has also been used in the large American Intergroup Study that evaluated the efficacy of high-dose chemotherapy in primary breast cancer.<sup>4</sup> The preliminary information from this presentation indicates that CPB may reduce the relapse rate in high-risk breast cancer but is also associated with a significant treatment-related mortality of 7.4%.

The other type of high-dose chemotherapy regimen that has been used frequently in breast cancer is the STAMP-V (or CTCb) regimen,<sup>1</sup> containing cyclophosphamide 6 g/m<sup>2</sup>, thiotepa 500 mg/m<sup>2</sup>, and carboplatin 800 mg/m<sup>2</sup>. The use of the CTCb regimen has been reported in advanced breast cancer in a recently published randomized study.<sup>5</sup> This so-called Philadelphia trial compared a late intensification strategy with CTCb and continued conventional-dose chemotherapy with the CMF (cyclophosphamide, methotrexate, and fluorouracil) regimen. No advantage for the high-dose regimen over conventional-dose chemotherapy could be demonstrated. CTCb has also been used in a randomized study in high-risk primary breast cancer.<sup>6</sup> In that trial, CTCb was used as a late intensification after 4 courses of conventional-dose adjuvant chemotherapy with FEC (fluorouracil, epirubicin, and cyclophosphamide). Again, the high-dose regimen was randomized against continued conventional-dose therapy, this time with multiple courses of intensified FEC. The outcome of this study was reported with a median follow-up of only 20 months, and there was no indication that CTCb was superior to conventional-dose therapy at this early time point.

### THE CTC REGIMEN

A high-dose chemotherapy regimen that is similar to the CTCb regimen<sup>7</sup> has been used in 2 Dutch randomized studies in breast cancer. This regimen, called CTC, incorporates cyclophosphamide 6 g/m<sup>2</sup>, thiotepa 480 mg/m<sup>2</sup>, and carboplatin 1600 mg/m<sup>2</sup>. Thus, the carboplatin dose is twice as high as that in the CTCb regimen. In addition, the drugs in the CTC regimen are administered as short-term (30- to 60-minute) infusions divided over 4 days, whereas the drugs in the CTCb regimen are administered as a continuous intravenous infusion over 4 days.

It is currently uncertain whether the differences between CTC and CTCb are of clinical significance. Recent findings suggest, however, that the way in which thiotepa and cyclophosphamide are infused may significantly influence the activation of the prodrug, cyclophosphamide. Cyclophosphamide itself is inactive, but must be metabolized into its active form, 4-hydroxycyclophosphamide, by a cytochrome P450 (CYP450) enzyme. 4-Hydroxycyclophosphamide is in equilibrium with its tautomeric form aldophosphamide, which rapidly degrades into the alkylating metabolite phosphoramidate mustard. This activation route of cyclophosphamide is effectively inhibited by thiotepa, which blocks the CYP450 enzyme at very low

concentrations.<sup>8</sup> As a result, a continuous infusion of thiotepa may lead to sustained thiotepa concentrations that continuously inhibit the cyclophosphamide-activating enzyme. Pharmacokinetic modeling studies using the NONMEM program suggest that this may not importantly alter the area under the curve of the 4-hydroxycyclophosphamide concentration but does significantly decrease the 4-hydroxycyclophosphamide peak concentrations. Whether these changes lead to decreased efficacy, decreased toxicity, or both is at this point unclear.

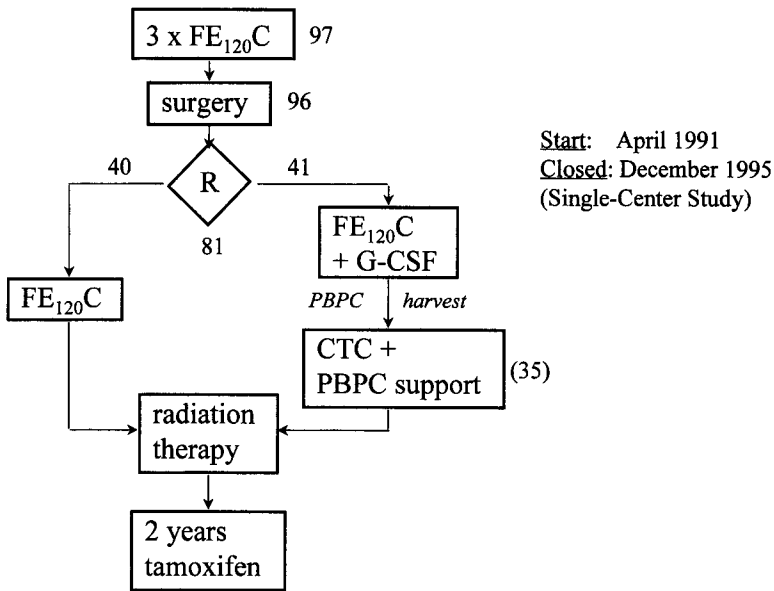
The CTC regimen has been used extensively as a high-dose regimen in breast cancer and in other solid tumors.<sup>9-11</sup> Double and even triple administrations of CTC have been investigated as well.<sup>12,13</sup> After second or third courses of CTC, end-organ toxicity has been observed that does not occur or is exceedingly rare after a single administration. These toxicities include hemorrhagic cystitis (despite the administration of mesna), veno-occlusive disease, and hemolytic uremic syndrome. The frequency of these toxicities is clearly dose dependent, and 3 subsequent administrations of CTC in a dose that has been decreased by one third have been shown to be both feasible and effective in advanced breast cancer.<sup>14</sup>

### **THE CTC REGIMEN IN RANDOMIZED STUDIES OF HIGH-RISK BREAST CANCER**

In 1998, we published the results of a small randomized study of CTC in 81 patients.<sup>15</sup> All patients had received up-front FEC chemotherapy for breast tumors with extensive axillary node metastases, and all had undergone surgery. The patients were then randomized to receive either a fourth course of FEC followed by radiotherapy and tamoxifen or the same treatment followed by high-dose chemotherapy with CTC and peripheral blood stem cell transplantation between the FEC course and the radiotherapy (Figure 1). The CTC regimen was well tolerated, and there were no toxic deaths. With a median follow-up of 49 months (range, 21–76 months), there was no difference in progression-free or overall survival between the groups.

Although clearly negative, it must be kept in mind that this study was small and was powered to detect only a 30% difference in relapse-free survival. Thus, a smaller but still clinically important advantage for the high-dose regimen could easily have been missed.

The approach developed in the small randomized phase 2 study was subsequently used to design a Dutch national study.<sup>16</sup> For this trial, patients younger than 56 years, who had undergone either a mastectomy or breast conserving surgery for stage II or III breast cancer, and who had no distant metastases were eligible if they had at least 4 tumor-positive axillary lymph nodes. All Dutch university hospitals, the 2 cancer institutes, and 1 large regional hospital participated. The study was funded by the Dutch Health Insurers Council (College



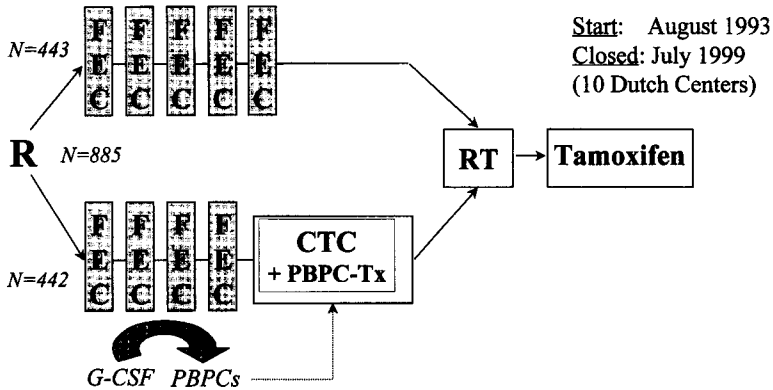
**Figure 1.** Study design of the randomized phase 2 study in patients with primary breast cancer and extensive axillary node metastases.<sup>15</sup> CTC, high-dose cyclophosphamide, thiotepa, and carboplatin;  $FEC_{120}C$ , fluorouracil 500 mg/m<sup>2</sup>, epirubicin 120 mg/m<sup>2</sup>, and cyclophosphamide 500 mg/m<sup>2</sup> q 3 weeks; G-CSF, granulocyte colony-stimulating factor; PBPC, peripheral blood progenitor cell; R, randomization.

voor Zorgverzekeringen). This arrangement precluded crossing over from the conventional treatment arm to the high-dose treatment arm: high-dose chemotherapy was not available outside clinical studies.<sup>17</sup>

The study design is depicted in Figure 2. Patients in the conventional treatment arm received 5 courses of FEC, underwent radiation therapy, and were started on tamoxifen. Patients in the high-dose arm received identical treatment, except that the fifth course of FEC was replaced by high-dose chemotherapy with CTC. In these patients, the second FEC course was used to mobilize and harvest stem cells. For this purpose, granulocyte colony-stimulating factor (G-CSF) (filgrastim) was used following the second FEC course as described.<sup>9</sup>

A total of 885 patients were randomized between August 1993 and July 1999. Preliminary outcome data have been reported at the 2000 American Society of Clinical Oncology meeting in New Orleans.<sup>16</sup> With a median follow-up of 35 months, the 3-year recurrence-free survival (RFS) for the conventional-dose arm was 65%, and that for the high-dose arm was 72%. This apparent benefit for high-dose chemotherapy was of borderline significance (2-sided *P* value, .057, log-rank test).





**Figure 2.** Study design of the Dutch national study of high-dose chemotherapy in high-risk breast cancer.<sup>16</sup> CTC, high-dose cyclophosphamide, thiotepa, and carboplatin; G-CSF, granulocyte colony-stimulating factor; PBPC, peripheral blood progenitor cell; R, randomization; RT, radiotherapy; Tx, transplant.

At the time of the analysis, however, only half of the events required for a statistically reliable analysis had taken place.

A subgroup analysis of the first 284 patients was planned for the year 2000 at the request of the sponsor of the study. For this part of the study, a significant recurrence-free and overall survival benefit was apparent at a median follow-up of 53 months. Because the RFS benefit for the whole patient population is not statistically significant at this point in time, the results should be interpreted with caution.<sup>18</sup>

Consequently, these data certainly do not prove the superiority of high-dose chemotherapy over conventional therapy.

## DISCUSSION

At this time it is clearly impossible to know whether high-dose chemotherapy is superior to standard-dose chemotherapy in breast cancer. The randomized studies that have been reported in primary breast cancer were either severely underpowered<sup>15,19</sup> or have insufficient follow-up to be analyzed reliably.<sup>16-18</sup>

The outcome of the Philadelphia study,<sup>5</sup> which focused on advanced breast cancer, is a special case; because it was relatively large, it has sufficient follow-up and was clearly negative. The results of this study should, however, not be overinterpreted. Two specific points deserve particular attention:

1. Patients in the conventional chemotherapy group received a substantially higher (!) cumulative dose of chemotherapy than those randomized to the

high-dose group. A median of 8 additional courses of CMF were given to patients randomized to the conventional arm of the study. For cyclophosphamide alone, this amounts to 11.2 g/m<sup>2</sup>, which is almost twice the dose of cyclophosphamide in the CTCb regimen.

2. Patients were randomized at a maximum of 8 weeks after the last dose of conventional chemotherapy. Following these 8 weeks, a bone marrow harvest and/or stem cell mobilization and harvest had to take place and the patients had to be scheduled for high-dose therapy. As a result, patients could have had up to 3 months' delay between their last chemotherapy and the actual start of the high-dose therapy. This could very well be detrimental to the results of high-dose therapy, since regrowth of tumor must have taken place in the chemotherapy-free interval.

These points of criticism certainly do not invalidate the findings of the Philadelphia study, which clearly argue against the previously common practice of administering CTCb chemotherapy routinely several months after a response to conventional chemotherapy. It is, however, conceivable that any benefit of high-dose therapy could have been missed as a result of the study design.

## CONCLUSION

In the adjuvant chemotherapy setting, a fairly large number of randomized studies, in both the United States and Europe, have recently completed patient accrual or will shortly do so, and many of these will have adequate follow-up by 2002 or 2003. Studies of adjuvant therapy in high-risk breast cancer require many years of follow-up before a definitive analysis can be done. Until that time, a case can be made to initiate studies that directly compare the efficacy and toxicities of the different high-dose regimens. One such study is already in progress in North America, in which the CTCb regimen is compared with a high-dose regimen incorporating busulfan, melphalan, and thiotepa. Similar comparative studies involving the CTC regimen are being considered in the Netherlands.

## REFERENCES

1. Van der Wall E, Beijnen JH, Rodenhuis S. High-dose chemotherapy regimens for solid tumors: a review. *Cancer Treat Rev* 21:105–132, 1995.
2. Peters WP, Shpall EJ, Jones RB, et al. High-dose combination alkylating agents with bone marrow support as initial treatment for metastatic breast cancer. *J Clin Oncol* 6: 1368–1376, 1988.
3. Peters WP, Ross M, Vredenburgh JJ, et al. High-dose chemotherapy and autologous bone marrow support as consolidation after standard-dose adjuvant therapy for high-risk primary breast cancer. *J Clin Oncol* 11:1132–1143, 1993.
4. Peters WP, Rosner G, Vredenburgh J, et al. A prospective, randomized comparison of

- two doses of combination alkylating agents (AA) as consolidation after CAF in high-risk primary breast cancer involving two or more axillary lymph nodes (LN): preliminary results of CALGB 9082/SWOG 9114/NCIC MA-13 [abstract]. *Proc ASCO* 18:1a, 1999. Abstract 2.
5. Stadtmauer EA, O'Neill A, Goldstein LJ, et al. Conventional-dose chemotherapy compared with high-dose chemotherapy plus autologous hematopoietic stem cell transplantation for metastatic breast cancer. *N Engl J Med* 342:1069–1076, 2000.
  6. The Scandinavian Breast Cancer Study Group 9401. Results from a randomized adjuvant breast cancer study with high dose chemotherapy with CTCb supported by autologous bone marrow stem cells versus dose escalated and tailored FEC therapy [abstract]. *Proc ASCO* 18:2a, 1999. Abstract 3.
  7. Rodenhuis S, Baars J, Schornagel JH, Vlasveld LT, et al. Feasibility and toxicity study of a high-dose chemotherapy regimen incorporating carboplatin, cyclophosphamide and thiotepa. *Ann Oncol* 3:855–860, 1992.
  8. Huitema ADR, Kerbusch T, Tibben MM, Rodenhuis S, Beijnen JH. Reduction of cyclophosphamide bioactivation by thioTEPA: critical sequence dependency in high-dose regimens. *Cancer Chemother Pharmacol* 46:19–27, 2000.
  9. Van der Wall E, Nooijen WJ, Baars JW, et al. High-dose carboplatin, thiotepa and cyclophosphamide (CTC) with peripheral blood stem cell support in the adjuvant therapy of high-risk breast cancer: a practical approach. *Br J Cancer* 71:857–862, 1995.
  10. Rodenhuis S, Van der Wall E, Ten Bokkel Huinink WW, et al. Pilot study of a high-dose carboplatin-based salvage strategy for relapsing or refractory germ cell cancer. *Cancer Invest* 13:355–362, 1995.
  11. Rodenhuis S, DeWit R, De Mulder PHM, et al. A multi-center prospect phase II study of high-dose chemotherapy in germ cell cancer patients relapsing from complete remission. *Ann Oncol* 12:1467–1473, 1999.
  12. Rodenhuis S, Westermann A, Holtkamp MJ, et al. Feasibility of multiple courses of high-dose cyclophosphamide, thiotepa and carboplatin for breast cancer or germ cell cancer. *J Clin Oncol* 14:1473–1483, 1996.
  13. Rodenhuis S, Huitema ADR, Baars JW, et al. Multiple courses of cyclophosphamide, thiotepa and carboplatin: managing toxicity by dose reduction and pharmacokinetic monitoring. In: Dicke KA, Keating A, eds. *Autologous Blood and Marrow Transplantation: Proceedings of the Ninth International Symposium, Arlington, Texas*. 1999, p. 422–434.
  14. Schrama JG, Baars JW, Holtkamp MMJ, Schornagel JH, Rodenhuis S. Phase II study of triple high-dose alkylating chemotherapy with cyclophosphamide, thiotepa and carboplatin in hormone-refractory breast cancer [abstract]. *Proc AACR* 41:332, 2000. Abstract 2108.
  15. Rodenhuis S, Richel DJ, Van der Wall E, et al. A randomized trial of high-dose chemotherapy and hematopoietic progenitor cell support in operable breast cancer with extensive axillary lymph node involvement. *Lancet* 352:515–521, 1998.
  16. Rodenhuis S, Bontenbal M, Beex L, et al. Randomized phase II study of high-dose chemotherapy with cyclophosphamide, thiotepa and carboplatin in operable breast cancer with 4 or more axillary lymph nodes [abstract]. *Proc ASCO* 19:75a, 2000. Abstract 86.
  17. De Vries EGE, Ten Vergert EM, Mastenbroek CG, Dalesio O, Rodenhuis S. Breast cancer studies in the Netherlands [letter]. *Lancet* 348:407–408, 1996.

18. McNamee D. High-dose chemotherapy positive in breast cancer trial [news]. *Lancet* 355:1973, 2000.
19. Hortobagyi GN, Buzdar AU, Theriault RL, et al. Randomized trial of high-dose chemotherapy and blood cell autografts for high-risk primary breast carcinoma. *J Natl Cancer Inst* 92:225–233, 2000.

# Immunotherapy With Activated T Cells After High-Dose Chemotherapy and Peripheral Blood Stem Cell Transplantation for Breast Cancer

*Lawrence G. Lum*

*Roger Williams Hospital, Providence, Rhode Island*

## ABSTRACT

Nontoxic approaches are needed to improve overall survival (OS) and progression-free survival (PFS) for patients with stage IIIb/IV breast cancer because conventional and high-dose chemotherapy (HDC) with peripheral blood stem cell transplant (PBSCT) has reached limiting toxicities. Patients were given multiple infusions of anti-CD3 (OKT3)-activated T cells (ATCs), interleukin (IL)-2, and granulocyte-macrophage colony-stimulating factor (GM-CSF) after PBSCT. ATCs were produced by activating peripheral blood T cells with OKT3 and IL-2. Phenotyping showed that ATCs were >95% CD3<sup>+</sup>, with roughly a 50:50 mix of CD4<sup>+</sup> and CD8<sup>+</sup> cells after culture. In the phase 1/2 immunotherapy trial (PBSCT and combination immunotherapy [IT]), 23 women with stage IIIb/IV breast cancer were given multiple infusions (3 doses of  $1 \times 10^{10}$  3 times per week for the first 3 weeks and  $2 \times 10^{10}$  per week for an additional 6 weeks), totaling up to  $21 \times 10^{10}$  ATCs each. They also received low-dose IL-2 (300,000 U/m<sup>2</sup> per day) between days 1 and 65 and GM-CSF between days 5 and 21 after PBSCT. Twenty patients received HDC, and 3 patients received dose-dense sequential chemotherapy. GM-CSF was given between 5 and 21 days after PBSCT. The patients received (1) carboplatin, cyclophosphamide, and thiotepa or (2) paclitaxel (Taxol), carboplatin, and cyclophosphamide followed by PBSCT. There were no treatment-limiting toxicities. OS was 70% and PFS was 50% after 32 months of follow-up in 23 patients. In a historical control group of 22 patients, OS was 50% and PFS was 10% at 32 months. The differences between those who received PBSCT and IT and those who received PBSCT are nearly significant (2-tailed  $P=.09$  for OS and PFS). In summary, the results from this approach are encouraging and warrant further investigation.

## INTRODUCTION

Breast cancer patients with  $\geq 4$  positive axillary lymph nodes are at high risk for local recurrence and metastasis.<sup>1</sup> The risk of recurrence correlates with the number of positive axillary lymph nodes.<sup>2,3</sup> Roughly half of these patients will develop metastatic disease within 18 months.<sup>4</sup> Although 60%–70% of patients achieve a complete remission after PBSCT and 30% of patients survive disease-free off therapy with 3-year follow-up,<sup>5,6</sup> long-term PFS remains low. Patients with high-risk metastatic or recurrent breast cancer are incurable using conventional therapies. Because conventional and high-dose chemotherapy regimens with PBSCT have reached dose-limiting toxicities, nontoxic immunologic approaches are needed to provide additional antitumor effect to improve OS and PFS for such patients.

Binding of anti-CD3 monoclonal antibody (mAb) to the human T-cell receptor triggers proliferation, cytokine secretion, and cytotoxicity.<sup>7–10</sup> Anti-CD3 ATCs are produced by OKT3 stimulation of peripheral blood mononuclear cells (PBMCs) in the presence of low-dose IL-2. ATCs can be expanded from PBMCs from normal subjects or patients with malignancy and mediate non–major histocompatibility complex (MHC)-restricted cytotoxicity.<sup>11–21</sup> Preclinical studies show that ATCs mediate non–MHC-restricted cytotoxicity to Daudi cells (lymphocyte-activated killer [LAK] targets), K562 cells (natural killer [NK] targets), leukemic blasts,<sup>22,23</sup> neuroblastomas,<sup>12</sup> and plasma cells in multiple myeloma.<sup>24</sup> Cytokines such as interferon (IFN)- $\gamma$ , tumor necrosis factor (TNF)- $\alpha$ , or GM-CSF, which may enhance antitumor activity, are produced by ATCs. ATCs exhibit both LAK cell–like and NK cell–like cytotoxic activity. They serve as vehicles for targeting antibodies or gene therapy products.<sup>25</sup>

In preclinical models, ATCs reduced MCA-38-LD liver metastases in C57BL/6 mice more effectively than the same number of activated NK cells.<sup>26</sup> Studies of human ATCs injected into SCID mice to treat human HT29 carcinoma tumors showed that ATCs could prevent deaths due to tumor.<sup>27</sup> ATCs infused at the time of syngeneic bone marrow transplant increased the survival of mice with syngeneic lymphoma.<sup>28</sup>

A clinical trial using ATCs in renal cell carcinoma and multiple myeloma patients has been reported in which peripheral blood lymphocytes (PBLs) activated with OKT3 were then infused with IL-2.<sup>29</sup> The therapy led to lymphocytosis with mild and tolerable toxicities, which were likely due to high-dose IL-2 therapy. A second study suggested that infusing the T cells during the white blood cell nadir after cyclophosphamide, enriching for CD4<sup>+</sup> cells, and using IL-2 may be important for obtaining clinical responses.<sup>30</sup> The phase 1 clinical trial using anti-CD3–activated CD4<sup>+</sup> cells and IL-2 after 300 or 1000 mg/m<sup>2</sup> intravenous cyclophosphamide showed promise, with the induction of 1 complete response, 2 partial responses, and 8 minor responses in patients with advanced cancers and non-Hodgkin's lymphoma.<sup>31</sup> These studies showed that ATCs can provide antitumor or

antilymphoma effects. Finally, donor lymphocyte infusions (DLIs) have been shown to provide antileukemia effects in patients who have relapsed after allogeneic bone marrow transplant for chronic myelogenous leukemia.<sup>32,33</sup>

This study presents clinical data on women with stage IIIb/IV breast cancer who were given IT consisting of ATCs, IL-2, and GM-CSF after PBSCT. We hypothesized that IT would provide the maximal antitumor effect when given after HDC and PBSCT.

## METHODS

### Generation and Expansion of ATCs

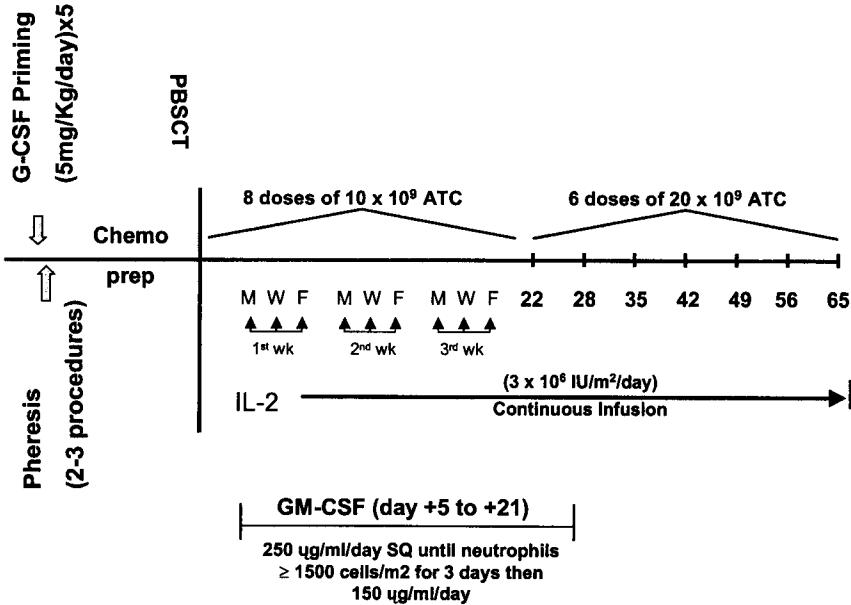
ATCs were produced by activating leukapheresis products containing from  $1.5$  to  $28.0 \times 10^9$  PBMCs with OKT3 (20 ng/mL) and culturing the PBMCs in 100 U/mL of IL-2 for 14 days. ATCs were harvested, washed, and cryopreserved in liquid nitrogen. Fluorescein isothiocyanate (FITC)- or phycoerythrin (PE)-conjugated mAbs (Becton Dickinson, San Jose, CA) were used to detect the expression of CD3, CD4, CD8, CD45RO/CD3, CD25, CD56, CD3/CD56, and CD16/CD56. Cytokine kits from R&D Systems were used to detect IFN- $\gamma$ , TNF- $\alpha$ , and GM-CSF.

### Clinical Protocol

This study was conducted at St. Luke's Medical Center in Milwaukee, Wisconsin, with a protocol that was approved by the US Food and Drug Administration and the St. Luke's Medical Center Human Subjects Committee. Informed consent was obtained on consent forms approved by the St. Luke's Medical Center Human Subjects Committee. The study was conducted between April 5, 1996, and February 1, 1999. The eligibility criteria included (1) women with histologically documented metastatic adenocarcinoma of the breast; (2) measurable or evaluable recurrent metastatic disease (stage IIIb or IV) documented by radiograph, computed tomography scan, nuclear medicine scan, or physical exam; and (3) refractory disease (lack of response to  $\geq 2$  regimens).

In the phase 1/2 IT clinical trial, 23 women with stage IIIb/IV breast cancer were given multiple infusions of ATCs totaling up to  $21 \times 10^{10}$  ATCs. The treatment schema is shown in Figure 1. Three doses of  $1 \times 10^{10}$  3 times per week were given for the first 3 weeks and  $2 \times 10^{10}$  per week were given for an additional 6 weeks. Low-dose IL-2 (300,000 U/m<sup>2</sup> per day) was given between days 1 and 65, and GM-CSF (125  $\mu\text{g}/\text{m}^2$  twice a week) was given between days 5 and 21. Twenty patients received PBSCT and IT after HDC, and 3 patients who had relapse after PBSCT received dose-dense sequential chemotherapy followed by IT. PBSCs were collected by leukapheresis after priming with G-CSF (10  $\mu\text{g}/\text{kg}$ ) for 5 days. When the target number of PBSCs was reached, pheresis was continued to obtain the

## ATC + IL-2 + GM-CSF Infusions after PBSCT for Stage IIIb or Metastatic Breast Cancer



**Figure 1.** Protocol schema. The schema shows the collection of peripheral blood stem cells (PBSCs) for transplantation (PBSCT) and mononuclear cells (PBMCs) for activated T-cell (ATC) expansions followed by PBSCT, infusions of ATC, interleukin (IL)-2, and granulocyte-macrophage colony-stimulating factor (GM-CSF). G-CSF, granulocyte colony-stimulating factor; SQ, subcutaneously.

starting number of T cells ( $10$ – $15 \times 10^9$ ). Seven of 20 patients received paclitaxel ( $300$ – $600$  mg/m<sup>2</sup>), cisplatin ( $55$  mg/m<sup>2</sup>), and cyclophosphamide ( $1875$  mg/m<sup>2</sup>) as a preparative regimen for PBSCT, and 13 of 20 patients received carboplatin ( $200$  mg/m<sup>2</sup>), cyclophosphamide ( $1500$  mg/m<sup>2</sup>), and thiotepa ( $125$  mg/m<sup>2</sup>). Three patients received a dose-dense sequential regimen of doxorubicin, paclitaxel, and cyclophosphamide before PBSCT and IT.

## RESULTS

Phenotyping showed that ATCs were  $>95\%$  CD3<sup>+</sup>, 50% CD4<sup>+</sup>, 50% CD8<sup>+</sup>, and  $<5\%$  CD56<sup>+</sup> after 2 weeks of ex vivo expansion. No B cells were detected. The ATCs from normal subjects produce IFN- $\gamma$ , TNF- $\alpha$ , and GM-CSF. Expansion of patient ATCs ranged from 6.29- to 34.5-fold, with the total ATCs harvested ranging from 17.6 to 380 billion.



Table 1. PBSCT and Immunotherapy\*

No.	Age, y	Chemotherapy	Stage†	Detectable Disease‡	Survival, d‡	Status, d	No. Cells at Harvest, $\times 10^{10}$	Fold Expansion	ATC Toxicities >Grade III
1	40	Taxol 500, Carbo, Cy	IV	Yes	Alive, 857	Progressed, 490	23	11.36	Skin rash, hemoglobin, platelets
2	38	Taxol 500, Carbo, Cy	IV	Yes	Alive, 847	No progression	24	9.62	None
3	51	Taxol 500, Carbo, Cy	IV	Yes	Alive, 721	No progression	32	13.54	None
4	39	Taxol 500, Carbo, Cy	IV	Yes	Died, 197	Progressed, 119	38	35	None
5	31	Taxol 500, Carbo, Cy	IIIb	No	Alive, 714	Progressed, 172	19	10.72	None
6	53	Taxol 300, Carbo, Cy	IV	Yes	Died, 150	Progressed, 106	20	8.18	Skin rash
7	60	Taxol 600, Carbo, Cy	IV	No	Alive, 584	No progression	34	6.29	None
8	51	CTC	IV	Yes	Died, 502	Progressed, 84	19	7.55	Fever
9	51	Dose dense	Relapse‡	—	Alive, 433	No progression	12	9.35	None
10	50	CTC	IIIb	No	Alive, 430	Progressed, 445	1.76	15.9	None
11	35	CTC	IV	Yes	Alive, 430	Progressed, 185	26	168.50	None
12	45	Dose dense	Relapse‡	—	Alive, 329	No progression	26	18.05	None
13	36	CTC	IV	Yes	Alive, 857	No progression	25	8.33	None
14	36	Dose dense	Relapse‡	—	Died‡	Progressed, 44	23.6	15.03	None
15	45	CTC	IV	Yes	Alive, 311	No progression	8.6	6.46	None
16	53	CTC	IV	No	Alive, 283	No progression	16	12.30	None
17	54	CTC	IV	Yes	Died, 108	Progressed, 108	25.7	17.1	None
18	39	CTC	IV	No	Alive, 154	No progression	32	7.92	None
19	44	CTC	IV	Yes	Alive, 137	No progression	29	34.52	None
20	52	CTC	IV	Yes	Alive, 99	No progression	22	14.50	None
21	46	CTC	IV	Yes	Alive, 80	No progression	NA	NA	None
22	53	CTC	IV	Yes	Alive, 66	No progression	NA	NA	None
23	53	CTC	IV	Yes	Alive, 14	No progression	NA	NA	None

\*Carbo, carboplatin; Cy, cyclophosphamide; CTC, cyclophosphamide, thiotepa, and carboplatin (STAMP V); NA, not available; dose dense, adriamycin, taxol, and cyclophosphamide. †At the time of transplant. ‡After transplant.

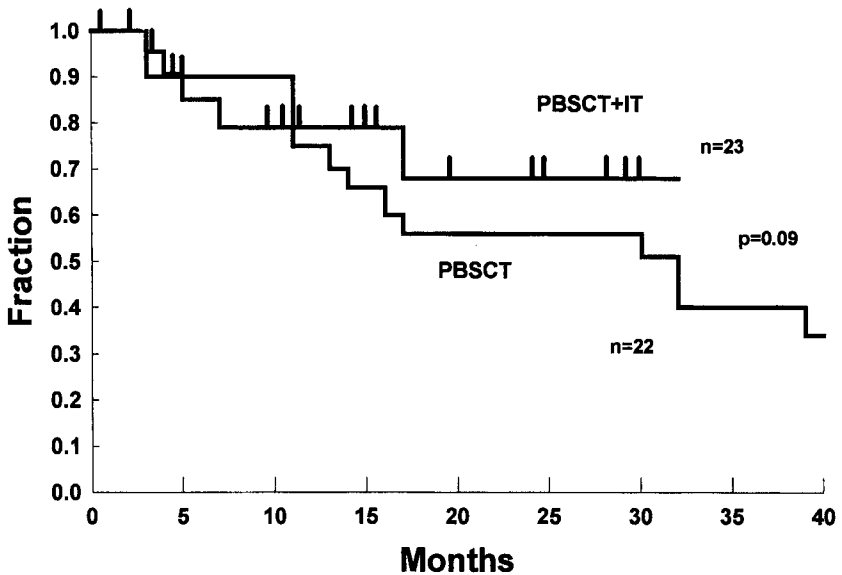
Table 1 summarizes the clinical data including the patient's age, stage, presence or absence of disease at the time of PBSCT, survival in days after PBSCT, survival free of progression after PBSCT, number of ATCs harvested, fold expansion, and toxicities related to ATC infusions. All patients were given at least  $4 \times 10^8$  G-CSF-primed peripheral blood mononuclear cells at the time of PBSCT. All patients were engrafted, and there were no delays in engraftment. There were no deaths due to regimen-related toxicities or dose-limiting toxicities of IT. The patients received continuous-infusion IL-2 or daily subcutaneous IL-2 injections. All patients finished the IT portion of the protocol. OS was 70% and PFS was 50% after 32 months of follow-up in 23 patients (Figures 2 and 3). In an historical control group of 22 patients who received PBSCT alone, OS was 50% and PFS was 10% at 32 months. The difference between those who received PBSCT and IT and those who received PBSCT alone is nearly significant, with a 2-tailed *P* value of .09 for OS and PFS.

In vitro immune function tests show that anti-CD3/anti-CD28-costimulated proliferative responses could be detected 3 months after PBSCT, whereas anti-CD3-stimulated proliferative responses remained depressed. Sequentially phenotyping for T cells, B cells, and NK cells using monoclonal antibodies directed at CD3, CD4, CD8, and CD56 cells was not revealing. Standard  $^{51}\text{Cr}$  release assays were used to measure the cytotoxic ability of ATCs directed at Daudi cells (LAK targets) and K562 cells (NK targets) before the infusions and of PBLs from the patients during and after ATC infusions. There was no correlation between the presence/absence of cytotoxicity or magnitude of cytotoxicity with clinical responses in the patients.

## DISCUSSION

The clinical results using combination IT and PBSCT after HDC or dose-dense sequential chemotherapy for metastatic breast cancer are remarkable. Fifteen of 20 patients in the PBSCT and IT group had measurable disease at the time of transplant. Even though most patients had bulky disease, it is encouraging that more patients who had measurable disease did not progress immediately after PBSCT. It is important to note that the historical controls were transplanted only after they had been treated into remission using 4 cycles of cyclophosphamide, adriamycin, and fluorouracil (CAF), whereas those who received PBSCT and IT did not always enter remission after 4 cycles of CAF. If all things were equal, the group that received PBSCT and IT should have been at a much higher risk for relapse or progressive disease. The statistical comparisons with the historical control group of 22 patients who received PBSCT after Stamp V (cyclophosphamide, thiotepa, and carboplatin) conditioning showed that improvements in OS and PFS in the PBSCT and IT group were better than in the group that received

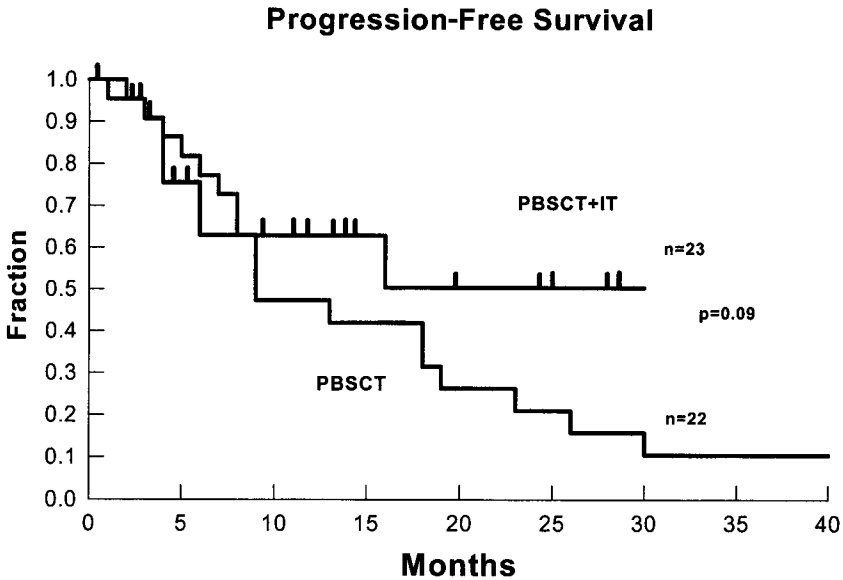
## Overall Survival



**Figure 2.** Survival curves. *PBSCT+IT* shows the overall survival for 23 patients who received peripheral blood stem cell transplantation (*PBSCT*) followed by combination immunotherapy (*IT*) for stage IIIb/IV breast cancer; the *PBSCT* curve shows 22 patients with stage IV breast cancer who received *PBSCT* after Stamp V (cyclophosphamide, thiotepa, and carboplatin) conditioning alone.

*PBSCT* alone (near statistical significance,  $P=0.09$ ). This was surprising and quite encouraging, because the original study was designed to find a 20% improvement in OS or PFS in a group of 60 patients with stage IIIb or IV disease. The differences between the 2 groups occurred despite the fact that the historical control group was treated with adjuvant CAF chemotherapy until they achieved a state of minimal residual disease before *PBSCT*. Therefore, if the study group had less disease at the time of transplant, the overall survival and progression-free survival data may have been better.

Data from the 3 patients who received *PBSCT* and *IT* after dose-dense sequential chemotherapy provide useful clinical information, because the patients had relapsed after *PBSCT* following Stamp V conditioning. These 3 patients included in the *PBSCT* and *IT* group received stem cell support and *IT* after sequential chemotherapy with adriamycin, paclitaxel, and cyclophosphamide (Cytoxan) instead of Stamp V. The dose-dense sequential approach was used because a second round of HDC was deemed to be excessively toxic for those who



**Figure 3.** Progression-free survival curves. *PBSCT+IT* shows the progression-free survival for 23 patients with stage IIIb/IV breast cancer who received peripheral blood stem cell transplantation (PBSCT) followed by combination immunotherapy (IT); the *PBSCT* curve represents 22 patients who received PBSCT after Stamp V (cyclophosphamide, thiotepa, and carboplatin) conditioning alone.

had relapsed within a year after PBSCT. All 3 patients had measurable disease at the time of transplant, and 2 of the 3 did not progress during the period of observation.

In vitro immune monitoring data show that anti-CD3 (OKT3)-induced proliferative responses remain depressed >3 months after PBSCT, and these responses could be corrected or partially corrected in anti-CD3/anti-CD28–costimulated cultures in a manner similar to that reported earlier in autologous and allogeneic bone marrow transplantation (BMT) recipients.<sup>34</sup> Sequentially phenotyping for T cells, B cells, and NK cells using monoclonal antibodies directed at CD3, CD4, CD8, and CD56 cells was not revealing. Nearly all of the patients had inverted CD4/CD8 ratios early after PBSCT. The proportions of CD4 and CD8 cells gradually normalized over a period of 6–12 months. Because there was no correlation between the proportions of CD4 and CD8 subsets or non-MHC-restricted cytotoxicity directed at Daudi or K562 targets and clinical responses, other factors that were not assessed may be responsible for the clinical responses.

OS and PFS data obtained from this phase 1/2 clinical trial are encouraging. If the trend continues and the data can be confirmed in a larger group of patients, this

may be the first demonstration that autologous ex vivo expanded ATCs can produce a durable antitumor effect when given after autologous PBSCT. Our earlier studies using ATCs without the use of HDC or dose-dense sequential chemotherapy were not successful in inducing even partial remissions. These results suggest that IT immediately after PBSCT or dose-dense sequential chemotherapy may indeed take advantage of the minimal tumor burden that exists after HDC or dose-dense chemotherapy to provide an antitumor effect. Longer follow-up and a larger cohort of patients would help confirm these encouraging findings.

### ACKNOWLEDGMENTS

This work was supported in part by funds from the American Cancer Society, Immunex Corp., Birnshein Foundation, and St. Luke's Medical Center, Milwaukee, Wisconsin. The author thanks Dr. Robert Taylor, Dr. Jonathan Treisman, Pam Lyon, Kristine Gleesing, Kathy Bielinski, and the Vince Lombardi Cancer Center nurses for their contribution and dedication to patient care. Special thanks to Dr. Ann Lefever and members of the William Schuett Cell Laboratory for their dedicated efforts in producing activated T cells. I thank Sandy Hogan for her secretarial support. Part of this article was presented at the 13th International Symposium on Molecular Biology of Hematopoiesis, New York, New York, July 16, 2000, and the European Group for Blood and Marrow Transplantation (EBMT) Meeting, Florence, Italy, September 2000.

### REFERENCES

1. Bookman MA, Goldstein LJ, Scher RM. Medical management of early-stage breast cancer [review]. *Curr Probl Cancer* 15:157-232, 1991.
2. Nemoto J, Vana J, Bedwani RN. Management and survival of female breast cancer: results of a national survey by the American College of Surgeons. *Cancer* 45:2917-2917, 1980.
3. Carter CL, Allen C, Henson DE. Relation of tumor size, lymph node status, and survival in 24,740 breast cancer cases. *Cancer* 63:181-187, 1989.
4. Haskell CM, Lowitz BB, Casciato DA. Breast cancer. In: Casciato DA, Lowitz BB, eds. *Manual of Clinical Oncology*. Boston, MA: Little, Brown, 1988, p. 150-165.
5. Antman K, Bearman SI, Davidson N. *Dose Intensive Therapy in Breast Cancer: Current Status*. New York, NY: Alan R. Liss, 1990.
6. Jones RB, Shpall EJ, Ross M. AFM induction chemotherapy, followed by intensive alkylating agent consolidation with autologous bone marrow support for advanced breast cancer: current results. *Proc ASCO* 7:121, 1990.
7. Van Wauwe JP, De Mey JR, Gooseens JG. OKT3: a monoclonal anti-human T lymphocyte antibody with potent mitogenic properties. *J Immunol* 124:2708-2713, 1980.
8. Meuer SC, Hodgdon JC, Hussey RE, Protentis JP, Schlossman SF, Reinherz EL. Antigen-

- like effects of monoclonal antibodies directed at receptors on human T cell clones. *J Exp Med* 158:988–993, 1983.
9. Meuer SC, Hussey RE, Cantrell DA, et al. Triggering of the T3-Ti anti-receptor complex results in clonal T cell proliferation through an interleukin 2 dependent autocrine pathway. *Proc Natl Acad Sci U S A* 81:1509–1513, 1984.
  10. Weiss A, Imboden JB. Cell surface molecules and early events involved in human T lymphocyte activation. *Adv Immunol* 41:1–38, 1987.
  11. Ochoa AC, Gromo G, Alter BJ, Sondel PM, Bach FH. Long-term growth of lymphokine-activated killer (LAK) cell: role of anti-CD3, beta-IL 1, interferon-gamma and -beta. *J Immunol* 138:2728–2733, 1987.
  12. Anderson PM, Bach FH, Ochoa AC. Augmentation of cell number and LAK activity in peripheral blood mononuclear cells activated with anti-CD3 and interleukin-2: preliminary results in children with acute lymphocytic leukemia and neuroblastoma. *Cancer Immunol Immunother* 27:82–88, 1988.
  13. Chen BP, Malkovsky M, Hank JA, Sondel PM. Nonrestricted cytotoxicity mediated by interleukin-2 expanded leukocytes is inhibited by anti-LFA-1 monoclonal antibodies (MoAb) but potentiated by anti-CD3 MoAb. *Cell Immunol* 110:282–293, 1987.
  14. Lotzova E, Savary CA, Herberman RB, et al. Augmentation of antileukemia lytic activity by OKT3 monoclonal antibody: synergism of OKT3 and interleukin-2. *Natl Immunol Cell Growth Reg* 6:219–223, 1987.
  15. Yang SC, Fry KD, Grimm EA, Roth JA. Successful combination immunotherapy for the generation *in vivo* of antitumor activity with anti-CD3, interleukin 2, and tumor necrosis factor alpha. *Arch Surg* 125:220–225, 1990.
  16. Ueda M, Joshi ID, Dan M, et al. Preclinical studies for adoptive immunotherapy in bone marrow transplantation, II: generation of anti-CD3 activated cytotoxic T cells from normal donors and autologous bone marrow transplant candidates. *Transplantation* 56:351–356, 1993.
  17. Uberti JP, Joshi I, Ueda M, Martilotti F, Sensenbrenner LL, Lum LG. Preclinical studies using immobilized OKT3 to active human T cells for adoptive immunotherapy: optimal conditions for the proliferation and induction of non-MHC restricted cytotoxicity. *Clin Immunol Immunopathol* 70:234–240, 1994.
  18. Anderson PM, Blazar BR, Bach FH, Ochoa AC. Anti-CD3 + IL-2 stimulated murine killer cells: *in vitro* generation and *in vivo* antitumor activity. *J Immunol* 142:1383–1394, 1989.
  19. Anderson PM, Ochoa AC, Ramsay NKC, Hasz D, Weisdorf D. Anti-CD3 + interleukin-2 stimulation of marrow and blood: comparison of proliferation and cytotoxicity. *Blood* 80:1846–1853, 1992.
  20. Ting C-C, Hargrove ME, Yun YS. Augmentation by anti-T3 antibody of the lymphokine-activated killer cell-mediated cytotoxicity. *J Immunol* 141:741–748, 1988.
  21. Ochoa AC, Hasz DE, Rezonsew R, Anderson PM, Bach FH. Lymphokine-activated killer activity in long-term cultures with anti-CD3 plus interleukin 2: identification and isolation of effector subsets. *Cancer Res* 49:963–968, 1989.
  22. Sosman JA, Oettel KR, Hank JA, Fisch P, Sondel PM. Specific recognition of human leukemia cells by allogeneic T cell lines. *Transplantation* 48:486–495, 1989.
  23. Sosman JA, Oettel KR, Hank JA, Sondel PM. Isolation and characterization of human

- cytolytic cells (CTL) with specificity for allogeneic leukemic blasts [abstract]. *FASEB J* 3 (Part 1):A506, 1989.
24. Massaia M, Attisano C, Peola S, et al. Rapid generation of antiplasma cell activity in the bone marrow of myeloma patients by CD3-activated T cells. *Blood* 82:1787-1797, 1993.
  25. Culver KW, Berger M, Miller AD, Anderson WF, Blaese RM. Lymphocyte gene therapy for adenosine deaminase deficiency [abstract]. *Pediatr Res* 31:149A, 1992.
  26. Loeffler CM, Platt JL, Anderson PM, Katsanis E. Antitumor effects of IL-2 liposomes and anti-CD3-stimulated T-cells against murine MCA-38 hepatic metastasis. *Cancer Res* 51:2127-2132, 1991.
  27. Murphy WJ, Conlon KC, Sayers TJ, et al. Engraftment and activity of anti-CD3-activated human peripheral blood lymphocytes transferred into mice with severe combined immune deficiency. *J Immunol* 150:3634-3642, 1993.
  28. Katsanis E, Xu Z, Anderson PM, et al. Short-term *ex vivo* activation of splenocytes with anti-CD3 plus IL-2 and infusion post-BMT into mice results in *in vivo* expansion of effector cells with potent anti-lymphoma activity. *Bone Marrow Transplant* 14:563-572, 1994.
  29. Curti BC, Longo DL, Ochoa AC, et al. Treatment of cancer patients with *ex vivo* anti-CD3-activated killer cells and interleukin-2. *J Clin Oncol* 11:652-660, 1993.
  30. Saxton ML, Longo DL, Wetzel HE, et al. Adoptive transfer of anti-CD3-activated CD4<sup>+</sup> T cells plus cyclophosphamide and liposome-encapsulated interleukin-2 cure murine MC-38 and 3LL tumors and establish tumor-specific immunity. *Blood* 89:2529-2536, 1997.
  31. Curti BD, Ochoa AC, Powers GC, et al. Phase I trial of anti-CD3-stimulated CD4<sup>+</sup> T cells, infusional interleukin-2, and cyclophosphamide in patients with advanced cancer. *J Clin Oncol* 16:2752-2760, 1998.
  32. Kolb HJ, Mittermuller J, Clemm C, Holler E. Donor leukocyte transfusions for treatment of recurrent chronic myelogenous leukemia in marrow transplantation patients. *Blood* 76:2462-2465, 1990.
  33. Kolb HJ, Schattenberg A, Goldman JM, et al. Graft-versus-leukemia effect of donor lymphocyte transfusions in marrow grafted patients. European Group for Blood and Marrow Transplantation Working Party on Chronic Leukemia. *Blood* 86:2041-2050, 1995.
  34. Joshi I, Lum LG, Gutta R, Ledbetter J, Sensenbrenner L, WSU BMT Team. Defects in anti-CD3-induced proliferative responses in lymphocytes (PBL) from BMT patients can be repaired by adding 9.3 (anti-CD28) [abstract]. *Blood* 78:229a, 1991.

# Summary of Current Studies in Breast Cancer Using High-Dose Chemotherapy and Autologous Blood Cell Transplantation, Including NCI-C CTG MA.16

***Stefan Glück, Michael Crump, Douglas Stewart, Andrew Arnold, Stephen Couban, Peter Kirkbride, Mark Levine, Susan O'Reilly, Kathleen Pritchard, Anne Smith, Dongsheng Tu, Janet Dansey, Susan Marlin, Lois Shepherd***

*The National Cancer Institute of Canada  
Clinical Trials Group, Canada*

## ABSTRACT

The evidence for use of high-dose chemotherapy (HDCT) and autologous stem cell transplantation (autoSCT) for breast cancer still remains inconclusive at best. A number of randomized prospective controlled phase 3 trials (RCTs) have been either published or presented recently or are under way in North America and Europe. It will be crucial to complete the RCTs and obtain the data when all studies reach mature status. Only then will level I evidence become available to determine the efficacy and effectiveness of HDCT and autoSCT in breast cancer.<sup>1</sup> Unfortunately, level I evidence (using RCTs) has not been a focus for clinical investigations. More than 20,000 patients underwent this treatment worldwide, but only 8 phase 3 studies (with participation of far fewer than 1000 patients with metastatic breast cancer and little more than 1500 patients with high-risk early breast cancer) have been either reported or published. A definite answer is still not available. Therefore, it remains extremely important that patients with metastatic and high-risk early breast cancer participate in RCTs. In Canada, the National Cancer Institute Clinical Trials Group started such a study in 1997: NCI-C CTG MA.16. The objectives of the study are to compare overall survival, response rates, toxicity, and quality of life. Women 16 years of age and older with responding metastatic breast cancer and no prior chemotherapy with an Eastern Cooperative Oncology Group (ECOG) performance status of 0–2 are eligible for this study, using either standard-dose chemotherapy (SDCT) or HDCT with autoSCT. The calculated sample size (300 randomized patients) has the power of 80% to detect a difference of 13% at 2 years for overall survival. The patients are randomized after 4 cycles of conventional SDCT to receive further SDCT at the discretion of the oncologist and patient or 1 cycle of



HDCT. The SDCT is either anthracycline based (for patients not exposed to anthracyclines) or a taxane-based combination (for patients who were given anthracyclines in the adjuvant setting). High-dose mitoxantrone (70 mg/m<sup>2</sup> intravenously [IV]), cyclophosphamide (6000 mg/m<sup>2</sup> IV), and carboplatin (1600 mg/m<sup>2</sup> IV) are used as the HDCT protocol. This treatment was delivered in 4 equal doses over 4 days, followed by autoSCT infusion. Patients were stratified according to induction chemotherapy (ID), response to ID, metastatic distribution, and receptor status. The study is continuing accrual. The median overall survival is not yet reached. Only after a full analysis with a sufficient number of events (analysis planned for the end of 2000), can conclusions regarding differences between arms be drawn.

## INTRODUCTION

The use of HDCT and autoSCT for breast cancer has steadily increased over the last decade. The Autologous Blood and Marrow Transplantation Registry (ABMTR) reported >3000 cases in 1996.<sup>2</sup> This increase is due to encouraging results from a variety of phase 1 and phase 2 studies, one RCT published in 1995,<sup>3</sup> and a number of retrospective and contemporary analyses.<sup>4</sup> At the same time, mortality due to the treatment steadily decreased from >15% to 2–3%.<sup>2</sup> Toxicity also decreased, mainly because of the use of peripheral blood (rather than bone marrow) as a source of stem cells, the use of modern supportive care including hematopoietic growth factors, and better patient selection. A number of phase 3 studies were initiated in the early and mid-1990s, but accrual was slow because in the United States this promising treatment was offered to patients outside of clinical trials long before enough evidence became available to support such decisions. European and Canadian institutions demanded more evidence<sup>1</sup> to justify the rather toxic and potentially dangerous treatment. Results from a number of phase 3 trials evaluating HDCT and autoSCT for breast cancer have recently become available. These results are summarized below.

### Metastatic Breast Cancer

A study presented by Lotz et al.<sup>5</sup> shows a median time to progression of 15.7 vs. 26.9 months ( $P=0.04$ ). After 2 years, a lower proportion of patients treated with HDCT had relapsed compared with those treated with conventional chemotherapy (27% vs. 52%). Overall survival was not significantly different between the groups; however, a trend for longer median overall survival (16 vs. 36 months) was observed with the intensive regimen. These differences are clinically relevant but statistically not significant because the sample size is too low (only 61 patients accrued into the study, PEGASE 04) to have the power to detect any statistically meaningful difference in survival.

Stadtmauer et al.<sup>6</sup> recently published a study of 199 patients with metastatic breast cancer that has enough power to detect a difference of survival of 20% at 2 years. The median follow-up was reported to be 37 months. This trial did not show any benefit of the alkylator-based HDCT over SDCT in terms of event-free (6 vs. 10 months) or overall (24 vs. 26 months) survival.

The study published by Bezwoda et al.<sup>3</sup> in 1995 clearly demonstrates the advantage of mitoxantrone-based HDCT and autoSCT over the standard treatment, as used by the South African authors. Both progression-free and overall survival were statistically better, with clinically meaningful advantage. Obviously, this study has a few flaws, eg, unusual standard treatment that is not being used in North America or Europe, a rather small sample size of 45 patients in each arm, and tamoxifen intervention more common in the HDCT arm.

Peters et al.<sup>7</sup> presented a randomized prospective study of alkylator-based HDCT for patients with metastatic breast cancer at the 1996 American Society of Clinical Oncology meeting. Although the study found a statistically significant difference in outcome between treatment arms, it did not compare standard treatment with HDCT but instead compared immediate vs. delayed HDCT and autoSCT after reaching complete remission to AFM (doxorubicin, fluorouracil, and methotrexate) nonalkylator induction chemotherapy. Interestingly, delayed HDCT (providing a treatment-free interval) resulted in superior survival to high-dose consolidation immediately after induction chemotherapy.

One of the abovementioned studies is positive; one is negative, showing only minimal differences in outcomes; one shows a positive trend (with statistically significant difference for time to progression) but does not have enough power to detect any significant differences; and one does not compare HDCT vs. SDCT. In spite of these results, the question regarding the use of HDCT and autoSCT in patients with metastatic breast cancer remains unanswered and therefore controversial. The National Cancer Institute of Canada Clinical Trials Group designed a study, NCI-CTG MA.16,<sup>8</sup> to answer the question of whether consolidation treatment with HDCT and autoSCT can improve survival. This treatment is being compared with what presently in North America and Europe is considered standard treatment for first-line therapy of metastatic breast cancer. The study was initially designed to have a power of 80% to detect a difference of 20% in overall survival at 2 years. By June 1999, approximately 1 year ahead of time, the fully calculated sample size was reached; therefore, it was agreed to increase the sample size by an additional 100 patients. A smaller, 13% difference in survival at 2 years could then be detected with a power of 80%. Currently, no other active study in North America has the potential to scientifically solve the question of consolidation treatment with HDCT and autoSCT for patients with metastatic breast cancer. The extended NCIC-CTG MA.16 does have the potential to answer this highly important clinical question.

## HDCT and AutoSCT as Adjuvant Treatment

Results from 4 different randomized prospective phase 3 studies in patients with high-risk stage II breast cancer (usually  $\geq 10$  axillary lymph nodes involved with metastatic disease) have been presented or published.

Peters et al.<sup>9</sup> presented data on 783 randomized patients, treated with 4 cycles of CAF (cyclophosphamide, doxorubicin, and fluorouracil) followed by 1 cycle of CDDP (cisplatin)/cyclophosphamide/BCNU using either high doses and autologous stem cell rescue or doses that require only granulocyte colony-stimulating factor (G-CSF) support. At 3 years, the differences in event-free and overall survival were statistically not different (68% vs. 64% and 78 vs. 80%, respectively). In this patient population, clinical studies require a much longer follow-up time. As an example, results of studies that eventually proved the effectiveness of HDCT and autoSCT in multiple myeloma or non-Hodgkin's lymphoma initially were negative at 2- to 3-year follow-up. In the adjuvant setting, many studies in patients with breast cancer often have shown positive results only after 5 or more years of observation time. The study of Peters et al.<sup>7</sup> is too early to deliver final results. Very high incidence of treatment-related deaths (7.5%) in the high-dose arm were observed in the first year. Recently, Peters et al.<sup>9</sup> reported an evaluation of the first 341 patients who were followed up for at least 3 years. Although a statistically significant difference could not be detected, the event-free survival at 3 years identified a difference of 12% in favor of the HDCT arm. The number of relapses was 126 in the intermediate-therapy arm vs. 85 in the HDCT arm.<sup>10</sup>

Bergh et al.,<sup>11</sup> representing the Scandinavian Breast Cancer Study Group, reported on their trial of 525 patients in the same patient population as that of Peters et al. They compared directly 3 cycles of FEC (fluorouracil, epirubicin, and cyclophosphamide) followed by 1 cycle of high-dose CTCb (cyclophosphamide, thiotepa, and carboplatin) and autoSCT to a so-called standard arm, consisting of 9 cycles of "tailored FEC" supported by G-CSF. At 20 months, they reported 78 relapses in the tailored FEC and 50 relapses in the HDCT arm (differences not significant). At the same time, 40 deaths have been observed in each arm. In the nontransplant arm, a few patients developed secondary acute leukemia and myelodysplasias. This very balanced study is obviously comparing 2 different dose-intensified regimens rather than 1 HDCT and autoSCT to conventional/standard treatments. The total dose as well as the dose intensity is higher in the FEC arm than in the transplantation arm. The observation of secondary hematologic malignancies in the standard arm is worrisome. Follow-up is again too short to draw final conclusions.

Rodenhuis et al.<sup>12</sup> published a study comparing 4 cycles of FEC at a standard dose to 1 cycle of FEC plus 1 cycle of CTCb followed by autoSCT. The patients all had apex of the axilla lymph nodes positive for involvement with breast cancer. In another study, Rodenhuis et al.<sup>13</sup> reported that 885 patients with high-risk breast

cancer were randomized to receive or not receive HDCT and autoSCT and are evaluable: 72% of patients on the HDCT arm remain free of recurrence vs. 65% on the standard arm ( $P=.057$ ). At 3 years, the overall survival is 84% and 80%, respectively (not significant). The follow-up for the study remains short, but the interim analysis of the first 284 patients (which was required by the Dutch regulatory body) identified a statistically significant improvement of overall survival ( $P<.039$ ).<sup>13</sup>

Hortobagyi et al.<sup>14</sup> studied 78 patients with high-risk breast cancer (as defined by either >10 lymph nodes positive after resectable breast cancer or  $\geq 4$  lymph nodes positive after neoadjuvant chemotherapy). All patients received 8 cycles of FAC (fluorouracil, doxorubicin, and cyclophosphamide), and 50% were randomized to receive 2 cycles of HDCT (using VP-16, cyclophosphamide, and cisplatin) followed by autoSCT. The 4-year disease-free survival was 52% vs. 51% (by actual treatment received;  $P=.84$ ), and overall survival was 64% vs. 63% (by actual treatment received;  $P=.66$ ), which is statistically not different between the groups. The authors concluded that because of the modest sample size this trial has a limited statistical power; however, the data suggest that HDCT with autoSCT as consolidation after 8 cycles of adjuvant chemotherapy is unlikely to produce major improvements over FAC alone.

Bezвода<sup>15</sup> presented a study randomizing 154 patients with stage II breast cancer involving  $\geq 10$  lymph nodes. Patients who received chemotherapy with autoSCT fared significantly better than those in the control arm. However, according to the article by Horton,<sup>16</sup> this study was reevaluated, and the presented data could not be confirmed. The study may have indeed have been carried out in a fraudulent manner. Thus, this should be considered when referring to the data and conclusions of the article.

In the adjuvant setting, more and better-designed studies are necessary to clearly show whether HDCT and autoSCT is superior treatment to standard chemotherapy in patients with high-risk stage II breast cancer.

## CONCLUSIONS

To date, no definite answers are available to the initial question, whether HDCT and autoSCT can improve quantity or quality of life. Paramount requirements to answer this question successfully include completing the available prospective, randomized phase 3 studies; using HDCT earlier in the course of treatment; applying drugs that are active in breast cancer; comparing the experimental treatment to true standard therapy; and using appropriate sample size to detect clinically meaningful and statistically significant differences. Within the next few years, a number of European<sup>17</sup> and 2 Canadian<sup>8,18</sup> studies that are currently accruing patients will contribute toward the important information regarding the role of HDCT and autoSCT for breast cancer.

## REFERENCES

1. Sackett DL. Rules of evidence and clinical recommendations on the use of antithrombotic agents. *Chest* 95:2S-4S, 1989.
2. Autologous Blood and Marrow Transplant Registry. Medical College of Wisconsin, Milwaukee, WI 53226, 1996.
3. Bezwoda WR, Seymore L, Dansey RD. High-dose chemotherapy with hematopoietic rescue as primary treatment or metastatic breast cancer: a randomized trial. *J Clin Oncol* 13:2483-2489, 1995.
4. Glück S, Crump M, Bociek G, Stewart D. High dose chemotherapy with autologous blood stem cell transplantation: increasing evidence for efficacy in patients with metastatic breast cancer. In: Dicke KA, Keating A, eds. *Autologous Blood and Marrow Transplantation, Proceedings of the Ninth International Symposium on Autologous Blood and Marrow Transplantation, Arlington, Texas*. Charlottesville, VA: Carden Jennings, 1999, p. 290-302.
5. Lotz JP, Cure H, Janvier M, et al. High dose chemotherapy with hematopoietic stem cell transplantation for metastatic breast cancer: results of the French protocol PEGASE 04. *Proc ASCO* 18:161a, 1999.
6. Stadtmayer EA, O'Neill A, Goldstein LJ, et al. Phase III randomized trial of high dose chemotherapy and stem cell support shows no difference in overall survival or severe toxicity compared to maintenance chemotherapy with cyclophosphamide, methotrexate and 5 fluorouracil for women with metastatic breast cancer who are responding to conventional induction chemotherapy: the Philadelphia intergroup study (PBT-1). *Proc ASCO* 18:1, 1999.
7. Peters WP, Jones RB, Vredenburgh J, et al. A large, prospective, randomized trial of high-dose combination alkylating agents (CPB) with autologous cellular support (ABMS) as consolidation for patients with metastatic breast cancer achieving complete remission after intensive doxorubicin-based induction therapy (AFM). *Proc ASCO* 15:49, 1996.
8. Crump M, Glück S, Stewart D, et al. A randomised trial of high-dose chemotherapy with autologous blood stem cell support (ASCT) compared to standard therapy in women with metastatic breast cancer: a National Cancer Institute of Canada Clinical Trials Group (NCIC CTG) Study [abstract]. *Proc ASCO*. NCIC CTG Protocol Number MA.16, 1997
9. Peters WP, Rossner G, Vredenburgh J, et al. A prospective randomized comparison of two doses of combination alkylating agents as consolidation after CAF in high risk primary breast cancer involving ten or more axillary lymph nodes: preliminary results of CALGB 9082/SWOG9114/NCICMA113. *Proc ASCO* 18:2a, 1999.
10. Peters WP, et al. Update on CALGB 9082/SWOG9114/NCICMA113. Presented at the Second Meeting of the Breast Cancer International Research Group, Edmonton, Alberta, Canada, June 26, 2000.
11. The Scandinavian Breast Cancer Study Group 9401. Results from a randomized adjuvant breast cancer study with high dose chemotherapy with CTCb supported by autologous bone marrow stem cells versus dose escalated and tailored FEC therapy. *Proc ASCO* 18:3a, 1999.
12. Rodenhuis S, Richel DJ, van der Wall, et al. Randomized trial of high dose chemotherapy and haematopoietic progenitor-cell support in operable breast cancer with extensive

- axillary lymph node involvement. *Lancet* 325:515–521, 1998.
13. Rodenhuis S, de Vries EGE, Beijnen JH, et al. Dutch randomized studies of HDCT with cyclophosphamide, thiotepa and carboplatin in high risk breast cancer. Presented at the Tenth International Symposium on Autologous Blood and Marrow Transplantation, Dallas, Texas, July 12, 2000.
  14. Hortobagyi GN, Buzdar AU, Champlin R, Gajewski J. Lack of efficacy of adjuvant high dose (HD) tandem combination chemotherapy (CT) for high risk primary breast cancer: a randomised trial. *Proc ASCO* 17:471, 1998.
  15. Bezwoda WR. Randomized controlled trial of high dose chemotherapy versus standard dose chemotherapy for high risk, surgically treated primary breast cancer. *Proc ASCO* 18:4a, 1999.
  16. Horton R. After Bezwoda. *Lancet* 355:942–943, 2000.
  17. Rosti G. European Bone Marrow Transplantation Group. Chair: Solid Tumors. 10th Symposium. Ravenna, Italy.
  18. A multicentre phase III randomised trial comparing docetaxel in combination with doxorubicin and cyclophosphamide (TAC) versus TAC followed by high dose chemotherapy with mitoxantrone, cyclophosphamide and vinorelbine with autologous peripheral stem cell transplantation and G-CSF in adjuvant treatment of operable breast cancer with 4 or more positive axillary nodes. TAX 321 (BCIRG 002).

# **Epirubicin/Paclitaxel Combination Mobilizes Adequate Amounts of Peripheral Blood Progenitor Cells to Support 3 Courses of High-Dose Dense Chemotherapy in Patients With Breast Cancer**

**Ugo De Giorgi, Giovanni Rosti, Maurizio Marangolo**

*Department of Oncology and Hematology, City Hospital, Ravenna, Italy*

## **ABSTRACT**

We are evaluating high-dose dense chemotherapy (HDDCT) in patients with breast cancer using 3 cycles of epirubicin 150 mg/m<sup>2</sup> (as a 2-hour infusion) and paclitaxel 400 mg/m<sup>2</sup> (as a 6-hour infusion) with peripheral blood progenitor cell (PBPC) support and filgrastim every 16–19 days. In this ongoing study, we are verifying the possibility of collecting large amounts of PBPCs to obtain a sufficient number of cells for 3 courses of HDDCT. The threshold fixed in our study was  $>6 \times 10^6$  CD34<sup>+</sup> cells/kg body weight. Our mobilizing regimen consisted of epirubicin 150 mg/m<sup>2</sup> given as a 2-hour infusion (day 1) and paclitaxel 175 mg/m<sup>2</sup> as a 3-hour infusion (day 2) plus colony-stimulating factor (CSF) (starting 24 hours after paclitaxel). Seventeen patients with stage II–IV breast cancer have been evaluated. In 16 patients (95%), adequate numbers of PBPCs were collected from a single leukapheresis, whereas 1 patient (5%) required 2 procedures. The majority of leukaphereses (59%) were performed on day 11 after epirubicin administration; all procedures were conducted on an outpatient basis. The median numbers of CD34<sup>+</sup>, CD34<sup>+</sup>CD33<sup>-</sup>, and CD34<sup>+</sup>CD38<sup>-</sup> cells/kg collected per patient were  $15.4 \times 10^6$ ,  $10.2 \times 10^6$ , and  $0.5 \times 10^6$ , respectively. The mobilizing regimen was quite well tolerated: neutropenia grade 4 was recorded in 16 of 17 patients, with a median duration of 3 days (range, 1–5 days). Results of 48 HDDCT courses showed grade 4 neutropenia for a median of 2 days (range, 0–4 days); no patient developed grade 4 thrombocytopenia, but grade 3 anemia was present in 18 courses of HDDCT. These preliminary data show that epirubicin and paclitaxel in combination with CSF are effective in releasing adequate amounts of PBPCs, which can then be safely employed to support multiple courses of HDDCT.

## INTRODUCTION

In the last few years, several thousand patients around the world have been treated with different types of dose-intensification strategies. This term usually refers to an increase in drug dosages. Several different approaches exist, and high-dose chemotherapy with autologous bone marrow transplantation (nowadays substituted with peripheral blood progenitor cells) is one possible strategy that has been extensively employed for breast cancer patients. Promising data from phase 2 studies have not been reproduced to date in controlled phase 3 randomized trials, even bearing in mind that some of the studies reported at the 1999 meeting of the American Society of Clinical Oncology (ASCO 99) had inadequate follow-up or used an unusual standard arm. At present, therefore, there is still much room to exploit the role of peak dose, a term that refers to high doses of drugs (generally alkylators) delivered once or twice within a 3- to 5-week period. Peak-dose strategy has been included in more recent programs, eg, the High-Dose Sequential Chemotherapy trials launched at the National Cancer Institute in Milan.<sup>1</sup> In those trials, active drugs are rapidly recycled, some at the maximum tolerated dose (eg, cyclophosphamide 7 g/m<sup>2</sup>) or medium dose (eg, epirubicin 120 mg/m<sup>2</sup>), with the final segment generally comprising peak-dose alkylators. Mature follow-up in patients with 10 or more positive nodes treated in the adjuvant setting shows a very impressive 49% disease-free survival. In recent years, after the failure in the clinical setting of the so-called Goldie and Coldman hypothesis of alternating chemotherapy, new theories have been generated. One of the most promising is the dose-dense delivery. With dose-dense delivery, the time intervals are reduced and the drug is delivered at ideal dose levels; thus, dose intensification is achieved by rapidly recycled treatment, rather than by dramatic dose escalation as is the case for peak dose. Some promising results have been published, such as those from the Memorial Sloan-Kettering Cancer Center in patients with high-risk breast cancer (median positive axillary nodes, 8; range, 4–25) who received sequential dose-dense therapy with adriamycin, paclitaxel, and cyclophosphamide.<sup>2</sup> The median intertreatment interval was 14 days (range, 13–36 days), and the median delivered dose-intensity was 92% of the planned level.<sup>3</sup> At a median follow-up of 48 months (range, 3–57 months), the actuarial disease-free survival rate is 78%. Other ongoing trials compared ATC (adriamycin followed by paclitaxel and cyclophosphamide at medium doses) with standard programs.<sup>4</sup> High-dose dense therapy is an evolution of the dose-dense concept (reduced intervals), but with an increase in density of the delivered drugs. This report deals with the phase 2 feasibility study conducted at the Department of Oncology and Hematology in Ravenna, Italy.



## MATERIALS AND METHODS

Seventeen patients underwent the high-dose dense regimen from February 1999 until June 2000; treated in the adjuvant setting were 12 with  $\geq 9$  positive axillary nodes (median, 14; range, 9–24), 4 with advanced disease, and 1 with inflammatory breast carcinoma arising in previous quadrantectomy. Median age was 47 years (range, 30–60 years). Sites of metastatic disease were lymph nodes in 2 cases and pleura in 1. Performance status was 0 (Eastern Cooperative Oncology group [ECOG] scale) for all patients. Five cases had estrogen receptor (ER)-negative tumors at diagnosis. The mobilizing treatment schedule was epirubicin 150 mg/m<sup>2</sup> in a 2-hour infusion followed the next day by paclitaxel 175 mg/m<sup>2</sup> in a 3-hour infusion. Twenty-four hours after paclitaxel infusion, patients received granulocyte-macrophage colony-stimulating factor (GM-CSF) (molgramostim, 3 patients) or G-CSF (filgrastim, 11 patients; lenograstim, 3 patients) at the dose of 5  $\mu$ g/kg subcutaneously until the final leukapheresis. The choice for hematopoietic growth factor was based on an ongoing randomized protocol at our institution. Patients were checked daily with blood counts. When white blood cell count (WBC) increased  $>3000 \mu$ L, CD34<sup>+</sup> cells were evaluated, and apheresis started when the peripheral circulating CD34<sup>+</sup> cells exceeded 40/ $\mu$ L, except for 1 case at 37.2 CD34<sup>+</sup>/ $\mu$ L.

## RESULTS

A total of 18 apheretic procedures were performed in 17 patients. The median number of CD34<sup>+</sup> cells collected was  $15.4 \times 10^6$ /kg (range, 4.5– $31.6 \times 10^6$ /kg), whereas the median number of circulating CD34<sup>+</sup> cells/ $\mu$ L at the day of apheresis was 267 (range, 37.2–717). The mobilizing regimen was well tolerated: no nonhematologic toxicities higher than grade 1 (Common Toxicity Criteria [CTC] version 2.0) occurred; neutropenia grade 4 was recorded in 16 of 17 patients, with a median duration of 3 days (range, 1–5 days); in 1 case, fever occurred. All patients were on ciprofloxacin prophylactic therapy, 500 mg po bid. Aphereses were performed a median of 11 days (range, 11–13 days) after the day of epirubicin treatment. A few days after the last apheresis (median, 7; range, 4–11 days), patients received the first of 3 courses of dose-dense chemotherapy, consisting of epirubicin 150 mg/m<sup>2</sup> as a 2-hour infusion followed the next day by paclitaxel 400 mg/m<sup>2</sup> as a 3-hour infusion. Thirty minutes before the administration of epirubicin, patients received dexrazoxane 1000 mg/m<sup>2</sup>. Peripheral blood progenitor cells were thawed and reinfused 48–72 hours after paclitaxel, and the next day, filgrastim 5  $\mu$ g/kg was added until polymorphonuclear cells (PMNs) were  $>1000/\mu$ L for 3 consecutive days or  $>10,000/\mu$ L (Figure 1). The first 2 patients were treated as inpatients until hematopoietic recovery; the others were

Epirubicin	150 mg/m <sup>2</sup>	Day 0	}
Paclitaxel	175 mg/m <sup>2</sup>	Day 1	
G-CSF or GM-CSF		From day 2	
↓			
Leukapheresis (>6×10 <sup>6</sup> /kg)			
↓			
Epirubicin	150 mg/m <sup>2</sup>	Day 0	} q 16–19 days × 3
Paclitaxel	400 mg/m <sup>2</sup>	Day 1	
PBPC infusion		Day 3 or 4	
G-CSF	5 μg/kg	Day 4 or 5	

**Figure 1.** High-dose dense treatment schedule. G-CSF, granulocyte colony-stimulating factor; GM-CSF, granulocyte-macrophage CSF; PBPC, peripheral blood progenitor cell.

allowed to return home and were checked at the outpatient clinic at our department. Blood counts were performed daily to provide continuous monitoring of hematologic toxicity. The mandatory criterion for returning home was to have a general practitioner participating in the study.

Seventeen patients received a total of 48 courses of high-dose dense chemotherapy. Reasons for not receiving the planned 3 courses were the following: neurotoxicity grade 3 (after the first high-dose cycle) in 1 patient and surgical option in the case of inflammatory disease.

The intertreatment interval was not fixed ab initio but was suggested to recycle at 16–19 days. In our study, the time between first and second course was a median of 18 days (range, 17–23 days), and between the second and third was also 18 days (range, 16–23 days).

### Hematologic Toxicity of the High-Dose Dense Regimen

Median dose of reinfused CD34<sup>+</sup> cells was 5.1×10<sup>6</sup>/kg (range, 1.5–10.5×10<sup>6</sup>/kg). In terms of neutropenia, no significant differences were observed among the 3 courses. Grade 4 neutropenia was recorded in 12 of 17 patients during the first cycle (median duration, 2 days; range, 1–4 days), in 12 of 16 patients during the second (median, 3 days; range, 1–4 days), and in 10 of 15 patients in the third (median, 2.5 days; range, 1–4 days). In 5 courses, febrile neutropenia developed. No patient had grade 4 thrombocytopenia; grade 3 for a maximum of 4 days (range, 1–4 days) was observed in 9 courses, without any difference regarding the course (3 for each course). Platelet transfusions were never requested. Grade 3 anemia was present in 18 courses, and in all cases, 2

packed red cell (PRC) transfusions were delivered. Grade 2 anemia was registered in nearly all other cases.

### **Nonhematologic Toxicity of the High-Dose Dense Regimen**

One case of short-lasting (2 days) grade 3 stomatitis was recorded in 1 patient. Neurotoxicity was one of our main concerns because the paclitaxel dose intensity was high in our study: 155.55 mg/m<sup>2</sup> per week for the 3 courses of dose-dense therapy or 133.68 mg/m<sup>2</sup> per week for the whole program. According to the CTC version 2.0, grade 1 neurotoxicity, sensory as well as motor, was recorded in all patients and developed after the first course of high-dose dense chemotherapy. After the second course, 8 of 16 patients developed grade 2 sensory and/or motor toxicity. Six patients showed grade 3 neurotoxicity at the end of the whole program for a period ranging from 3 days to 1 month. In no case did neurotoxicity higher than grade 1 persist after 30 days. In 1 patient, grade 3 neurotoxicity after the first cycle was the cause of withdrawal from the study. All patients who completed 2 or 3 courses of high-dose dense chemotherapy could return to their activities without neurologic sequelae. A follow-up, including electromyography evaluation, is ongoing to detect subliminal neurological damage. A prospective evaluation of ocular neurotoxicity is ongoing; it was partially presented in a recent letter.<sup>5</sup>

### **DISCUSSION**

No conclusions can yet be drawn with regard to the clinical efficacy of the high-dose dense program presented here because of the lack of adequate follow-up (median, 8 months; range, 1–15 months). No patients with high-risk operable breast cancer have relapsed so far. Four patients with advanced disease achieved a complete remission, lasting >13 months, 10 months, >8 months, and >6 months. In terms of feasibility, the primary end point of the study, the high-dose dense schedule is feasible, and neurotoxicity does not seem to be a limiting factor, despite the extremely high dose intensity achieved. Anemia was a constant toxicity in our experience, and erythropoietin will probably be added to the drug list. Future approaches may include a study comparing high-dose dense programs with standard chemotherapies in adjuvant, as well as advanced, disease. In the future, our group will consider the possibility of conducting a phase 2 study employing stem cells obtained by the *ex vivo* expansion of a minimal aliquot of bone marrow.

### **ACKNOWLEDGMENTS**

This study was supported by a grant of Istituto Oncologico Romagnolo.

**REFERENCES**

1. Gianni AM, Siena S, Bregni M, et al. Efficacy, toxicity, and applicability of high-dose sequential chemotherapy as adjuvant treatment in operable breast cancer with 10 or more involved axillary nodes: five-year results. *J Clin Oncol* 15:2312–2321, 1997.
2. Budman DR, Berry DA, Cirincione CT, et al. Dose and dose intensity as determinants of outcome in the adjuvant treatment of breast cancer. *J Natl Cancer Inst* 90:1205–1211, 1998.
3. Hudis C, Seidman A, Baselga J, et al. Sequential dose-dense doxorubicin, paclitaxel, and cyclophosphamide for resectable high-risk breast cancer: feasibility and efficacy. *J Clin Oncol* 17:93–100, 1999.
4. Burtness B, Windsor S, Holston B, et al. Adjuvant sequential dose-dense doxorubicin, paclitaxel and cyclophosphamide (ATC) for high-risk breast cancer is feasible in the community setting. *Cancer J Sci Am* 5:224–229, 1999.
5. De Giorgi U, Acciarri R, Fiorentini G, Rosti G, Marangolo M. Glaucoma and paclitaxel. *Lancet* 355:231, 2000.

# **CHAPTER 3**

## **SOLID TUMORS**



# **High-Dose Chemotherapy With Autologous Stem Cell Rescue for the Treatment of Patients With Brain Tumors**

***Sharon Gardner, Jonathan Finlay***

*New York University Medical Center, Department of Pediatric Oncology,  
New York, New York*

## **ABSTRACT**

Despite the use of surgery, irradiation, and standard-dose chemotherapy, the majority of patients with malignant brain tumors succumb to their disease. Over the past 15 years, investigators from several institutions have used high-dose chemotherapy with autologous stem cell rescue (ASCR) to try to improve survival in these patients. One of the earliest studies was a 2-drug regimen using thiotepa and etoposide in patients with recurrent brain tumors (Finlay JL, et al. *J Clin Oncol* 14:2495–2503, 1996). The overall response rate was 23% in 35 patients with radiographically measurable disease who survived at least 28 days after autologous bone marrow rescue. Subsequent studies have used several different combinations of chemotherapy, including thiotepa/etoposide with and without carboplatin, thiotepa/busulfan, thiotepa/cyclophosphamide, and cyclophosphamide/melphalan. Responses have been seen in patients with a variety of recurrent brain tumors including medulloblastoma, primitive neuroectodermal tumor (PNET), high-grade glioma, and central nervous system (CNS) germ cell tumors. Because of these encouraging results, high-dose chemotherapy with ASCR has more recently been used in young children newly diagnosed with brain tumors to avoid radiation therapy with its associated long-term sequelae in very young children. Responses with durable event-free survival were seen in children with medulloblastoma, PNET, and ependymoma. This approach is presently being examined by cooperative groups. There are 2 studies using sequential courses of high-dose chemotherapy with ASCR in children newly diagnosed with brain tumors currently under way within the Children's Oncology Group (COG). Future studies include examining the use of high-dose chemotherapy with ASCR vs. standard-dose therapy in a randomized setting and incorporating new agents such as temozolomide as part of the cytoreductive regimen. In addition, the use of high-dose chemotherapy with ASCR may be combined with other approaches including immunomodulation and gene therapy.

## INTRODUCTION

Brain tumors are the second most common malignancy in children and the most common solid tumor. They occur with a frequency of 24.5 per million children per year.<sup>1</sup> In adults, the incidence of CNS tumors per 100,000 population is 6.5 at 35 years, increasing to 70 by 70 years of age.<sup>2</sup> In the past 10 years, the survival rates for many malignancies, particularly pediatric tumors, have significantly improved. However, the survival of many children and adults with malignant brain tumors remains poor.

Over the past 15 years, investigators from several different institutions have used high-dose chemotherapy with autologous stem cell rescue in the treatment of patients with malignant brain tumors. The drugs considered to have the best tumoricidal activity against brain tumors are alkylating agents such as thiotepa, melphalan, BCNU, cyclophosphamide, and the platinum compounds. These drugs are particularly well suited for use at high doses with autologous stem cell support because of their steep linear-log dose-response curve. In addition, the principal dose-limiting toxicity for many of these drugs is bone marrow suppression. These drugs are cell-cycle nonspecific and therefore are not schedule dependent. Furthermore, the addition of nonalkylating agents, such as etoposide, synergistically enhances tumor kill.

One of the earliest studies using combination chemotherapy at high doses was a 2-drug regimen using thiotepa and etoposide with autologous bone marrow rescue in patients with recurrent brain tumors.<sup>3</sup> The study was piloted at the University of Wisconsin–Madison in 1986 and became a cooperative group study in the Children's Cancer Group in 1988. Of 35 patients with radiographically measurable disease who survived at least 28 days after autologous bone marrow rescue, the overall response rate (complete and partial responses) was 23%. Objective responses were seen in 4 of 14 assessable patients with high-grade glioma and in 2 of 6 patients with PNET.

In 1988, a 3-drug regimen using BCNU in addition to thiotepa and etoposide was initiated. Although responses were seen, the toxic mortality rate as a result of multiorgan system failure was unacceptably high.<sup>4</sup> In 1989, a third study using carboplatin with thiotepa and etoposide was opened at Memorial Sloan Kettering Cancer Center. There have been approximately 70 patients with brain tumors recurrent or refractory after irradiation and/or conventional-dose chemotherapy treated with this approach. Because of encouraging results seen in patients with recurrent brain tumors, this approach has more recently been used in infants and young children newly diagnosed with malignant brain tumors in an attempt to limit and, if possible, avoid the use of irradiation because of its long-term effects on the growth and development of young children.

Preliminary results of the 3-drug regimen (carboplatin, thiotepa, and etoposide) in patients with recurrent brain tumors as well as the use of high-dose



chemotherapy with ASCR in infants and young children newly diagnosed with malignant brain tumors are presented. In addition, results of studies using high-dose chemotherapy performed by other investigators are discussed.

## MATERIALS AND METHODS

### **Recurrent Malignant Brain Tumors in Children and Young Adults: Study of Carboplatin, Thiotepa, and Etoposide**

Patients with high-risk brain tumors that had either recurred or proven resistant to conventional chemotherapy and radiation therapy were considered eligible for this study. Patients had to have minimal residual disease before undergoing the high-dose chemotherapy. This could be achieved with either surgery or standard-dose chemotherapy.

Cytoreduction consisted of carboplatin as a 4-hour infusion on days -8, -7, and -6. The carboplatin was initially administered at a dose of 500 mg/m<sup>2</sup> per day; it was subsequently dosed using the Calvert formula with an area under the curve of 7 per day calculated from the urine creatinine clearance collected before each dose of carboplatin.<sup>5,6</sup> Thiotepa was administered at a dose of 300 mg/m<sup>2</sup> per day as a 3-hour infusion on days -5, -4, and -3. The etoposide was administered on the same days as the thiotepa at a dose of 250 mg/m<sup>2</sup> per day over 3 hours each day. Autologous stem cells, initially from bone marrow and more recently from peripheral blood, were reinfused on day 0.

### **Newly Diagnosed Malignant Brain Tumors in Children ≤6 Years of Age: Intensive Induction Chemotherapy Followed by Consolidation With High-Dose Carboplatin, Thiotepa, and Etoposide With Autologous Stem Cell Rescue**

Eligibility criteria included all children <3 years of age newly diagnosed with a malignant brain tumor irrespective of residual disease or neuraxis dissemination. In addition, children 3 to 6 years of age with poor-risk tumors, including 1) all high-grade gliomas, brain-stem tumors, and supratentorial PNETs, 2) medulloblastomas with neuraxis dissemination, and 3) ependymomas with residual disease and/or neuraxis dissemination, were eligible.

Patients received 5 cycles of induction chemotherapy including cisplatin, vincristine (first 3 cycles only), cyclophosphamide, and etoposide. Patients who had responsive disease or no evidence of disease after completion of the induction phase proceeded with consolidation chemotherapy. The consolidation phase consisted of high-dose carboplatin, thiotepa, and etoposide with autologous stem cell rescue as described above for patients with recurrent brain tumors. Children who had no

evidence of disease before consolidation did not receive any irradiation. Children with unresectable disease before consolidation received involved-field irradiation approximately 6 weeks after the high-dose chemotherapy.

## RESULTS

### **Recurrent Malignant Brain Tumors in Children and Young Adults: Study of Carboplatin, Thiotepa, and Etoposide**

Seventy patients with malignant brain tumors that had recurred or were refractory to irradiation and/or standard-dose chemotherapy were treated with carboplatin, thiotepa, and etoposide at Memorial Sloan Kettering Cancer Center or New York University Medical Center between 1989 and 2000. Diagnoses included medulloblastoma ( $n = 17$ ), other PNET ( $n = 13$ ), malignant glioma ( $n = 25$ ), germ cell tumor ( $n = 6$ ), ependymoma ( $n = 5$ ), and other ( $n = 4$ ). Ages ranged from 1 to 45 years (median, 14 years). Thirty-seven patients were rescued with bone marrow, 30 received peripheral blood, and 3 received both bone marrow and peripheral blood stem cells. Carboplatin was dosed using the Calvert formula in 22 patients who received bone marrow and in all patients who received peripheral blood stem cells. Overall, the toxic mortality rate was 11 of 70 (16%); however, in the past 5 years, the toxic mortality rate has been 1 of 33 (3%).

The 4-year event-free survival for patients with recurrent malignant glioma rescued with bone marrow was 10%. For patients with medulloblastoma and supratentorial PNET, the 4-year event-free survival was 35%. Five of 6 patients with recurrent CNS germ cell tumors are alive without evidence of disease, 4, 12, 15, 36, and 45 months after stem cell rescue.

### **Newly Diagnosed Malignant Brain Tumors in Children <6 Years of Age: Intensive Induction Chemotherapy Followed by Consolidation With High-Dose Carboplatin, Thiotepa, and Etoposide With Autologous Stem Cell Rescue**

Between 1992 and 1997, 75 children <6 years of age were enrolled in Head Start I. Diagnoses included medulloblastoma ( $n = 17$ ), other PNETs ( $n = 21$ ), ependymoma ( $n = 12$ ), high-grade glioma and rhabdoid tumors ( $n = 19$ ), and brain-stem tumors ( $n = 6$ ).

The median overall survival for the entire cohort was 25 months, with an estimated 6-year overall survival of 32%. The median event-free survival for the entire cohort was 14 months, with an estimated 3-year event-free survival rate of 29%. Patients with completely resected tumors had a better survival than those with incomplete resection (4-year overall survival of 57% vs. 30% [ $P=.03$ ] and 2-year

event-free survival of 54% vs. 25% [ $P=.06$ ], respectively). Survival in patients <3 years of age was not inferior to that in older children (median overall survival of 39 vs. 32 months, respectively;  $P=1.4$ ). Prognosis varied greatly between histologic subtypes. The estimated 4-year overall survival was 57% for medulloblastoma, 38% for PNET, 47% for ependymoma, and 16% for brain-stem tumors.

## DISCUSSION

Most patients with recurrent malignant brain tumors have a dismal outcome with standard-dose therapy. Not too long ago, some investigators suggested that routine surveillance scans in patients who had completed therapy for medulloblastoma were not even warranted, since no patients with recurrent disease survived.<sup>7</sup> However, the use of autologous bone marrow and, more recently, peripheral blood stem cells has allowed the administration of much higher doses of chemotherapy. In addition, improvements in supportive care and the use of autologous peripheral blood stem cells have significantly decreased toxicity associated with this therapy.

As expected, the best responses in the 3-drug regimen (carboplatin, thiotepa, and etoposide) were seen in patients with brain tumors, which tend to be more chemosensitive. These included medulloblastoma, supratentorial PNET, and germ cell tumors. Other investigators have found similar results. Mahoney et al.<sup>8</sup> reported the results of a pilot study from the Pediatric Oncology Group using escalating doses of cyclophosphamide and fixed doses of melphalan with autologous bone marrow rescue for children with recurrent or progressive malignant brain tumors. Responses were seen in 7 of 18 evaluable patients including 4 patients with medulloblastoma, 2 with germinoma, and 1 with ependymoma. The French have also seen responses in children using the combination of thiotepa and busulfan. Kalifa et al.<sup>9</sup> reported a 75% response rate in previously treated patients with medulloblastoma/PNET. Bouffet et al.<sup>10</sup> recently presented the results of the French Pediatric Oncology Society using high-dose etoposide and thiotepa for patients with refractory and recurrent malignant intracranial germ cell tumors. Six of 11 evaluable patients had responses (3 CR and 3 PR).

The treatment of very young children with malignant brain tumors is particularly challenging because of the aggressive nature of their tumors and also because of the potential long-term sequelae associated with treating these patients at such a young age. Preliminary results of the Head Start therapy indicate that a significant number of children newly diagnosed with malignant brain tumors can achieve durable remissions without the use of radiotherapy or prolonged maintenance chemotherapy.<sup>11</sup> This is particularly true for children with medulloblastoma, supratentorial PNET, and ependymoma. Additional studies are needed to confirm these results. At the present time there are 2 studies underway in COG for

children newly diagnosed with malignant brain tumors involving high-dose chemotherapy with autologous stem cell rescue.

Unfortunately, there are still patients with malignant brain tumors for whom the use of high-dose chemotherapy has not yet proven to be effective. These include patients with recurrent ependymoma or recurrent brain stem tumors and patients newly diagnosed with malignant gliomas. For these patients, modifications in the present high-dose regimens as well as other approaches are needed. Future studies include the use of other cytoreductive agents including the new oral alkylating agent temozolomide as well as intravenous busulfan. In addition, other approaches including the use of antiangiogenesis agents as well as immunomodulation and gene therapy, with and without high-dose chemotherapy, are being explored.

## REFERENCES

1. Duffner PK, Cohen ME, Myers MH, Heise HW. Survival of children with brain tumors: SEER program 1973–1980. *Neurology* 36:597–601, 1986.
2. Annegers JF, Schoenberg BS, Okazaki H, Kurland LT. Epidemiologic study of primary intracranial neoplasms. *Arch Neurol* 38:217–221, 1981.
3. Finlay JL, Goldman S, Wong MC, et al. Pilot study of high-dose thiotepa and etoposide with autologous bone marrow rescue in children and young adults with recurrent CNS tumors. *J Clin Oncol* 14:2495–2503, 1996.
4. Papadakis V, Dunkel IJ, Cramer LD, et al. High-dose carmustine, thiotepa and etoposide followed by autologous bone marrow rescue for the treatment of high risk central nervous system tumors. *Bone Marrow Transplant* 26:153–160, 2000.
5. Calvert AH, Newell DR, Gumbrell LA, et al. Carboplatin dosage: prospective evaluation of a simple formula based on renal function. *J Clin Oncol* 7:1748–1756, 1989.
6. Newell DR, Pearson AD, Balmanno K, et al. Carboplatin pharmacokinetics in children: the development of a pediatric dosing formula. *J Clin Oncol* 11:2314–2323, 1993.
7. Torres CF, Rebsamen S, Silber JH, et al. Surveillance scanning of children with medulloblastoma. *N Engl J Med* 330:892–895, 1994.
8. Mahoney DH, Strother D, Camitta B, et al. High-dose melphalan and cyclophosphamide with autologous bone marrow rescue for recurrent/progressive malignant brain tumors in children: a pilot Pediatric Oncology Group study. *J Clin Oncol* 14:382–388, 1996.
9. Kalifa C, Hartmann O, Demeocq F, et al. High-dose busulfan and thiotepa with autologous bone marrow transplantation in childhood malignant brain tumors: a phase II study. *Bone Marrow Transplant* 9:227–233, 1992.
10. Bouffet E, Baranzelli MC, Patte C, et al. High dose etoposide and thiotepa for refractory and recurrent malignant intracranial germ cell tumours (CNS-GCT). 9th International Symposium on Pediatric Neuro-Oncology [abstract]. *Neuro-Oncology* 2:S72, 2000.
11. Mason WP, Grovas A, Halpern S, et al. Intensive chemotherapy and bone marrow rescue for young children with newly diagnosed malignant brain tumors. *J Clin Oncol* 16:210–221, 1998.

# High-Dose Chemotherapy and Autologous Stem Cell Transplantation for Ovarian Carcinoma as Part of Initial Therapy

*Patrick J. Stiff*

*BMT Program, Loyola University Medical Center, Maywood, Illinois*

## ABSTRACT

Although high-dose chemotherapy and peripheral blood stem cell (PBSC) rescue are increasingly being used to treat patients with relapsed advanced epithelial ovarian cancer, their greatest benefit may be in treating patients before relapse. Two approaches have been tested: multicycle high-dose therapy with stem cell support as initial therapy or at the completion of standard-dose induction chemotherapy for responsive patients only. While conceptually attractive, several attempts at dose-dense (“double-dose”) chemotherapy with stem cell rescue have failed to yield a higher rate of pathologic complete remissions (CRs) than conventional-dose chemotherapy. According to data from relapsed patients, in which the best survivals after transplantation are seen in platinum-sensitive patients with tumor bulk <1 cm, the alternative approach would be to use high-dose therapy as a consolidation of initial remission. Phase 2 data from several sources, including a multicenter, retrospective analysis of 181 patients from France, indicate a survival and progression-free survival benefit of ~1 year for patients undergoing transplant in first remission. This approach is currently being investigated prospectively in a phase 3 trial in France (Groupe Investigation National Etude Cancer Ovaive [GINECO]), with trial enrollment to have been completed in December 2000. To take advantage of a favorable dose response for both carboplatin and paclitaxel, our group is exploring a novel regimen of high-dose paclitaxel (700 mg/m<sup>2</sup>), carboplatin (area under the curve [AUC] 28), and mitoxantrone (90 mg/m<sup>2</sup>) for high-risk patients in first remission, defined as suboptimal stage III/IV disease or optimal miliary stage III disease. At a median follow-up from diagnosis of 40 months of the first 18 such patients, 52% ± 13% were still progression free, and 14 of 18 were still alive. Whereas this compares favorably to the 20% 3-year progression-free survival (PFS) for patients treated with conventional paclitaxel and platinum, especially considering the fact that half had stage IV disease, it cannot be compared directly with conventional therapy results because our patient group by design

excludes those 15% or so who would have progressed on conventional therapy before completing induction therapy. The value of high-dose therapy as consolidation therapy of an initial remission should be verified in a phase 3 trial, and plans are being made for such a US trial with the assistance of the Autologous Blood and Marrow Transplant Registry (ABMTR).

## INTRODUCTION

Ovarian cancer, although initially chemosensitive, is frequently incurable using conventional therapies.<sup>1</sup> New paclitaxel/platinum chemotherapy regimens have improved the median survival for patients with bulky, advanced disease; however, they do not increase the proportion of patients with a surgical complete remission, and thus will likely cure few additional patients.<sup>2,3</sup> Optimal initial therapy for advanced ovarian carcinoma now appears to be carboplatin and paclitaxel, which, for suboptimal stage III and IV, produced a median PFS of ~16 months but a 3- to 4-year PFS of <20%.<sup>2</sup> As expected, patients with optimal stage III disease respond more favorably to these newer regimens, especially when intraperitoneal (IP) high-dose chemotherapy is included in the treatment regimen, as recently validated in two phase 2 trials.<sup>4,5</sup> The median survival for optimal stage III disease treated with IP therapy now exceeds 50 months. Because of its dismal prognosis, the favorable IP data, and the fact that ovarian cancer shares some of the features of other initially chemosensitive tumors that respond favorably to intensive high-dose chemotherapy regimens, interest in high-dose therapy has increased over the past 10 years. Data from several sources seem to indicate a benefit of high-dose therapy for relapsed patients who respond to salvage chemotherapy and have minimal bulk disease, defined as <1 cm.<sup>6-8</sup> Overall, ~20% of these patients appear to have a PFS that exceeds 3–4 years, and because of a lengthy PFS of 16–18 months, most who relapse subsequently respond to conventional salvage therapy.

As in other chemoresponsive diseases, however, the value of transplant therapy for this disease may be greatest in responding patients in first remission. Two approaches have been used: incorporating high-dose therapy into the initial induction regimen in lieu of conventional-dose therapy or as a consolidation of a first documented remission. The advantage of the first strategy is that tumors are treated before the development of acquired drug resistance, with the disadvantage that there may be as much as a 20% chance of de novo drug resistance that may not be overcome with the 7- to 10-fold dose increase of high-dose therapy. The advantage of the second strategy is that the tumors that have demonstrated chemosensitivity, such as the lymphomas and leukemias, are the only ones to benefit significantly from high-dose therapy; the disadvantage is that the initial courses of conventional therapy may induce drug resistance, which may not be overcome by dose-escalating the same drugs.

## HIGH-DOSE THERAPY AS INDUCTION THERAPY

Starting with Shea et al.,<sup>9</sup> several groups have reported the feasibility and safety of administering multiple cycles of high-dose carboplatin at 2- to 4-fold higher than conventional doses, either alone or with paclitaxel when given in conjunction with PBSCs. Numerous conventional chemotherapy trials of double-dose platinum have been performed, and most are negative; however, close inspection reveals that delivered dose intensity usually fell short of what was planned. In addition, only 1 agent was usually intensified. Administering PBSCs not only permits on-time drug delivery of the chemotherapy agents, but also several agents can be simultaneously administered in double doses. In the report of Shea et al.,<sup>9</sup> 18 patients received up to 3 courses of high-dose carboplatin 1200 mg/m<sup>2</sup> with PBSCs. Of the 5 evaluable patients with relapsed/persistent ovarian cancer, 3 had CRs, lasting 7.5, 8, and 11 months. An additional patient remained disease-free at 27 months, but she was consolidated with an ablative regimen after initially receiving 2 cycles of high-dose carboplatin with PBSCs.

Investigators at Sloan-Kettering<sup>10</sup> tested a strategy in previously untreated patients with advanced ovarian cancer of stem cell collection after high-dose cyclophosphamide and paclitaxel followed by carboplatin 1000 mg/m<sup>2</sup> with paclitaxel 250 mg/m<sup>2</sup> for 4 cycles with PBSC support, or later for 3 cycles, followed by a single cycle of high-dose melphalan at 140 mg/m<sup>2</sup>. A total of 55 patients were treated, of whom 44 were assessable for a response. Twelve of 22 patients (55%) with optimal stage IIC/IIIC had a pathologic CR, but only 3 of 15 patients with suboptimal stage III and 0 of 11 with stage IV had a similar response. Although surgical restaging was rigorous, the data for suboptimal stage III/IV are similar overall to that which would be expected for patients treated with conventional chemotherapy, as evidenced by the fact that patients treated with the cisplatin/paclitaxel arm of Gynecologic Oncology Group (GOG) 111 (suboptimal stage III and IV) had a pathologic CR rate of 26%. The results appeared to be slightly better than expected for patients with optimal stage III disease, which led to the development of a GOG multicenter trial of the regimen that consisted of 3 cycles of carboplatin and paclitaxel followed by the single course of melphalan in patients with optimal stage III disease. Of the 9 patients who completed the trial and underwent a second-look surgery, only 1 (11%) had a pathologic CR.<sup>11</sup> Thus, at least for the combination of double-dose carboplatin and paclitaxel, given at 2- to 3-week intervals with PBSCs, there appeared to be no benefit for patients with ovarian cancer, even for those with optimal disease after primary surgery.

This lack of benefit to this dose-dense, double-dose therapy was also seen in a more recent report of Schilder et al.,<sup>12</sup> using a similar strategy of multiple cycles of carboplatin at a somewhat higher dose (AUC 16) and paclitaxel 250 mg/m<sup>2</sup>. Again, response rates and durations were similar to the other 2 studies reported above.

Recently, however, this group has added high-dose topotecan ( $10 \text{ mg/m}^2$ ) to the high-dose carboplatin and paclitaxel combination and preliminarily reported improved results.<sup>13</sup> A second GOG pilot trial is under way to test this 3-drug combination, again in patients with optimal stage III disease. A more recent report of the same strategy, in which the topotecan is given daily over 5 days in an escalated fashion, produced an encouraging 61% pathologic CR rate for patients mostly with suboptimal disease.<sup>14</sup> One could argue that these more aggressive regimens are myeloablative, or at least significantly more intensive, to suggest that it is outside the realm of dose-dense, double-dose chemotherapy. If they are more effective than the carboplatin/paclitaxel regimens already tested, the next step will be to determine the optimal number of cycles to achieve this result. In addition, cumulative toxicity, cost, and frequency of delayed myelodysplasia and secondary acute leukemias will also need to be determined.

### HIGH-DOSE THERAPY AFTER STANDARD INDUCTION THERAPY

Approximately 15%–20% of patients with advanced ovarian cancer will have *de novo* drug resistance to conventional platinum-based induction therapy; they do not appear to benefit from high-dose therapy, similar to others with platinum-resistant disease. Thus, the rationale of transplanting patients only after responding to conventional therapy appears appropriate, as these nonresponsive patients would be excluded. Several pilot studies in the late 1980s suggested that this therapy could be performed with minimal toxicity and with a suggestion of benefit. The largest of these early trials, published in 1997 by Legroset al.,<sup>15</sup> consisted of 53 patients who were treated with either high-dose melphalan ( $140 \text{ mg/m}^2$ ) ( $n = 23$ ) or carboplatin  $1200 \text{ mg/m}^2$  and cyclophosphamide  $6.4 \text{ g/m}^2$  ( $n = 30$ ). Patients with advanced-stage disease were eligible if they responded clinically to 6 cycles of platinum-based chemotherapy (nontaxane) and underwent a second-look laparotomy. Of the 53, 37 were stage IIIc and had suboptimal III/IV disease, a positive second-look surgery, or a high-grade tumor; 15 had stage IV disease at diagnosis; and 22 had macroscopic disease at second look, with 18 undergoing secondary cytoreductive surgery. Nineteen patients had a negative second-look procedure, 7 had microscopic disease, and 5 had a clinical CR but refused a second-look procedure. These 31 were reported separately as having minimal residual disease (MRD) and compared to the 22 with macroscopic disease at the initiation of the second-look procedure. At a median follow-up of 81.5 months, 45.3% of the entire group of high-risk patients were alive, and 23% were progression-free, with a median disease-free survival (DFS) of 30.4 months. From the time of diagnosis for the entire group, the 5-year overall survival was 59.9%. For those with MRD at transplant, the median DFS was 36.7 months, and for the 19 with a negative second look, the DFS was 42.4 months and the median survival was 78.8 months. For



those with macroscopic disease, the median DFS was 23.6 months and the median overall survival was 39 months. The authors found no difference in survival between melphalan and carboplatin/cyclophosphamide preparative regimens.

Whereas these data appear better than for similar patients treated only with conventional chemotherapy, 3 major differences separate the patients treated in this study from those receiving conventional therapy. First, only responding patients were eligible for transplant, thus eliminating the 15%–20% who would have progressed during standard induction therapy. This would make the results in this study look artificially better than standard therapy. The second difference is that patients with optimal stage III disease with a negative second look were not eligible, again making comparisons to standard therapy difficult, because ~40%–50% of these patients would have been predicted to have a pathologic CR to conventional therapy. The transplantation of only patients with a positive second look or those initially with bulky disease would have made their results look inferior to that of patients treated conventionally. Finally, the proportion of stage IV disease of nearly 30% is slightly higher than that seen in a conventionally treated group; with an estimated survival of only 5% at 5 years, when treated conventionally, the results here would have been higher with a more typical (smaller) percentage of patients with stage IV disease. What can be said, however, is that those with a macroscopically positive second look appeared to do better than expected, with a median survival of 39 months compared with the expected survival of at best 20–24 months when treated with conventional salvage chemotherapy alone.

A follow-up retrospective study of 181 patients treated at multiple French centers has recently been reported, including the patients initially reported in 1997. The same selection criteria were used, again with optimal stage III patients with a negative second look generally excluded.<sup>16</sup> The 5-year survival for optimal stage III disease was 51%, and for suboptimal III/IV disease, 25%. Compared with what would be expected for patients treated with conventional platinum-based therapy at the time, the median PFS and overall survival rates appear to be 1 year longer, with the best results perhaps in the optimal stage III patients. This result would have been predicted from our data for chemosensitive relapsed disease, documenting a favorable outcome only for those with maximal bulk at transplant of <1 cm disease. Murakomi et al.<sup>17</sup> also treated a small cohort of patients with high-dose doxorubicin, cyclophosphamide, and cisplatin and autologous marrow transplants as consolidation therapy after a second-look procedure. In that report, those with microscopic disease at second look had a 70% survival at 4 years; however, those transplanted for macroscopic disease had only a 14% survival at the same time point.

Our group has treated 54 patients with a novel regimen of high-dose paclitaxel 700 mg/m<sup>2</sup> over 24 hours on day 1 of a 6-day cycle, carboplatin AUC 28 over a 5-day infusion starting on day 2, and mitoxantrone 90 mg/m<sup>2</sup> in 3 divided doses on

days 2, 4, and 6. The goal was to explore both high-dose carboplatin and paclitaxel at their maximal tolerated doses (MTDs) with stem cell support along with mitoxantrone, the most active agent *in vitro*, at escalated doses for platinum-resistant disease. Of the 54 patients, 18 were transplanted in first remission. All had adverse prognostic factors similar to those of the French investigation. Fifty percent had stage IV disease, with only 1 patient transplanted in clinical remission with optimal III disease; however, her disease was miliary at diagnosis. Of the 11 undergoing second-look surgery, 10 (90%) were positive, with 9 having disease <1 cm at the time of transplant. At a median follow-up from diagnosis of 40 months, 52%  $\pm$  13% were progression free, and 14 (78%) were alive. Considering that all but one had either suboptimal III or IV disease, one would have expected a median PFS of only 16 months and, at 40 months, only ~10%–15% would still be progression free. As with the French data, however, direct comparison to conventionally treated patients cannot be made, as only responding patients were considered eligible for this therapy.

### THE FUTURE

These promising data suggest a benefit of high-dose therapy as a consolidative therapy for patients with ovarian cancer, but valid direct comparisons cannot be made, as indicated above. The optimal strategy is to perform phase 3 trials. One such trial, sponsored by the GOG in the United States, closed prematurely because of lack of accrual, primarily due to lack of referrals to transplant centers. However, based on the favorable single-center and later multicenter retrospective data from France, GINECO is nearing completion of a similar trial. Patients with stage III/IV disease without a pathologic CR at second look or poor prognostic factors (stage IV, suboptimal primary surgery, and high-grade tumors) are randomized after second look to either high-dose therapy with cyclophosphamide 6 g/m<sup>2</sup>, carboplatin 1600 mg/m<sup>2</sup>, and stem cell transplant or 3 monthly courses of cyclophosphamide 600 mg/m<sup>2</sup> and carboplatin 300 mg/m<sup>2</sup>. Their accrual goal is 140 patients, with a goal of detecting a 25% difference in survival at 3 years. Additional trials are ongoing in Germany and through the European Group for Blood and Marrow Transplantation (EBMT) that explore up-front, multicycle, high-dose therapy as done by the investigators at Sloan Kettering and later the GOG.

A renewed effort at conducting a phase 3 trial in the US is under way, through the assistance of the ABMTR. The proposed design will be similar to the French study in that only responders will be eligible; however, it will differ in that, at the completion of induction therapy, responding patients will be randomized to either a single ablative transplant or 2 additional cycles of conventional paclitaxel and carboplatin therapy. Following completion of assigned therapy, a second-look procedure will be performed. The primary end point will be a 25% increase in those

with a pathologically negative second look. Those treated on the standard-dose arm with residual disease will then be permitted to undergo a transplant as consolidation of their documented response to conventional therapy, making this potentially more attractive to patients. The goal is to initiate this protocol in early 2001.

## REFERENCES

1. Kristensen GB, Trope C. Epithelial ovarian cancer. *Lancet* 349:113–117, 1997.
2. McGuire WP, Hoskins WJ, Brady MF, et al. Cyclophosphamide and cisplatin compared with paclitaxel and cisplatin in patients with stage III and stage IV ovarian cancer. *N Engl J Med* 334:1–6, 1996.
3. Trope C, Kristensen G. Current status of chemotherapy in gynecologic cancer [abstract]. *Semin Oncol* 24:S151, 1997.
4. Alberts DS, Liu PY, Hannigan EV, et al. Intraperitoneal cisplatin plus intravenous cyclophosphamide versus intravenous cisplatin plus intravenous cyclophosphamide for stage III ovarian cancer. *N Engl J Med* 335:1950–1955, 1996.
5. Markman M, Bundy B, Benda J, et al. Randomized phase II study of intravenous (IV) cisplatin (CIS)/paclitaxel (PAC) versus moderately high dose IV carboplatin (CARB) followed by IV PAC and intraperitoneal (IP) CIS in optimal residual ovarian cancer (OC): an intergroup trial (GOG, SWOG, ECOG) [abstract]. *Proc ASCO* 17:361a, 1998.
6. Stiff P, Bayer R, Camarda M, et al. A phase II trial of high-dose mitoxantrone, carboplatin, and cyclophosphamide with autologous bone marrow rescue for recurrent epithelial ovarian carcinoma: analysis of risk factors for clinical outcome. *Gynecol Oncol* 57:278–285, 1995.
7. Stiff PJ, Bayer R, Kerger C, et al. High-dose chemotherapy with autologous transplantation for persistent/relapsed ovarian cancer: a multivariate analysis of survival for 100 consecutively treated patients. *J Clin Oncol* 15:1309–1317, 1997.
8. Stiff PJ, Vuem-Stone J, Lazarus HM, et al. High dose chemotherapy and autologous stem cell transplantation for ovarian carcinoma: an autologous blood and marrow transplant registry report. *Ann Intern Med*. In press.
9. Shea TC, Mason J, Storniolo AM, et al. Sequential cycles of high-dose carboplatin administered with recombinant human granulocyte-macrophage colony-stimulatory factor and repeated infusions of autologous peripheral blood progenitor cells: a novel and effective method for delivering multiple courses of dose-intensive therapy. *J Clin Oncol* 10:464–473, 1992.
10. Aghajanian C, Fennelly D, Shapiro F, et al. Phase II study of “dose dense” high-dose chemotherapy treatment with peripheral blood progenitor-cell support as primary treatment for patients with advanced ovarian cancer. *J Clin Oncol* 16:1852–1860, 1998.
11. Shilder RJ, Shea TC. Multiple cycles of high dose chemotherapy for ovarian cancer. *Semin Oncol* 25:349–355, 1998.
12. Shilder RJ, Johnson S, Gallo J, et al. Phase I trial of multiple cycles of high-dose chemotherapy supported by autologous peripheral blood stem cells. *J Clin Oncol* 17:2198–2207, 1999.
13. Shilder RJ, Gallo J, Johnson SW, et al. Phase I study of multiple cycles of high dose topote-

- can, carboplatin and paclitaxel with peripheral blood stem cell support [abstract]. *Proc ASCO* 17:75a, 1998.
14. Prince HM, Rischin D, Quinn M, et al. Repetitive high-dose topotecan, carboplatin and paclitaxel with peripheral blood progenitor cell (PBSC) support in previously untreated ovarian cancer: results of a phase I/II study [abstract]. *Bone Marrow Transplant* 26 (Suppl 1): S34, 2000.
  15. Legros M, Dauplat J, Fluery J, et al. High-dose chemotherapy with hematopoietic rescue in patients with stage III to IV ovarian cancer: long-term results. *J Clin Oncol* 15: 1302–1308, 1997.
  16. Cure H, Extra JM, Viens P, et al. High dose chemotherapy with hematopoietic stem cell support as consolidation therapy for patients with platin-sensitive advanced epithelial ovarian cancer. *Proceedings of the Fourth International Symposium on High Dose Chemotherapy and Stem Cell Transplantation in Solid Tumors*. Berlin, Germany, 1998.
  17. Murakomi M, Shinozaka T, Miyamoto T, et al. The impact of autologous bone marrow transplantation on hematopoietic recovery after high dose cyclophosphamide, doxorubicin and cisplatin chemotherapy for patients with gynecological malignancy. *Asia Oceania J Obstet Gynecol* 19:85–93, 1993.

# High-Dose Therapy With Stem Cell Support for Small Cell Lung Cancer

*Anthony Elias*

*Dana-Farber Cancer Institute, Harvard Medical School, Boston, Massachusetts*

## ABSTRACT

The principles of dose and combination therapy are strongly supported by preclinical and clinical evidence. However, clinical success requires eradication of all clonogenic tumor if solely cytotoxic strategies are employed. The kinetics of tumor regrowth, particularly for small cell lung cancer (SCLC), suggests that near-eradication may be unimportant. Many established chemotherapeutic agents—including etoposide or teniposide, cisplatin or carboplatin, ifosfamide, cyclophosphamide, vincristine, and doxorubicin—have major activity against SCLC and strong preclinical rationales for dose escalation. Whether dose-intensive therapy can achieve greater survival and whether this benefit can outweigh the enhanced toxicities generated is the major unanswered question.

Methods to deliver dose-intensive therapy include shortening cycle length, increasing dose and/or number of agents over multiple cycles, or increasing dose as consolidation of clinical response. In many phase 2 trials evaluating high-dose therapy with hematopoietic cellular support, outcomes are frequently better than those reported by conventional-dose approaches. However, patient selection and perhaps staging biases contribute to these results. It is also questionable whether the possible benefit is generalizable to the entire population of patients with that disease and/or stage of disease, or if the treatment strategy is applicable only for the best of the best.

At the Dana-Farber Cancer Institute and Beth Israel Deaconess Medical Center, more than 55 patients with limited-stage and more than 30 with extensive-stage SCLC have been treated with high-dose combination alkylating agents (high-dose cyclophosphamide, carmustine, and cisplatin [CBP] or ifosfamide, carboplatin, and etoposide [ICE]) after response to conventional-dose induction therapy. Of the original cohort of 36 limited-stage SCLC (stages IIIA or B), 29 were in or near complete remission (CR) before treatment with high-dose CBP with marrow and peripheral blood progenitor cell (PBPC) support followed by chest and prophylactic cranial radiotherapy. For this group, the 5-year event-free survival is 53% (minimum follow-up, 40 months; range, to 11 years). By multivariate analysis,

response to induction was most important (CR/near CR best vs. partial remission [PR]), but short induction (<4 cycles), which included ifosfamide also, was associated with better prognosis. The updated results of the limited- and extensive-stage patients, as well as our experience with extrapulmonary small cell carcinoma, will be provided.

Two major complementary strategies to administer high-dose therapy for SCLC include a dose-intensive multicycle approach as initial treatment and the “later” intensification in responders. The advantages and disadvantages for each approach will be discussed. It may be optimal to merge the two strategies: a brief dose-intensive induction followed by a single or double cycle of stem cell-supported therapy followed by thoracic radiotherapy (TRT) and prophylactic cranial irradiation (PCI). Ultimately, randomized trials for patients with limited comorbidity will be necessary to determine whether the increased toxicity is worthwhile and for which subsets of patients this approach is curative. In most cases, if the treatment is deemed worthwhile, technological advances in supportive therapy will develop to increase feasibility and decrease cost. At present, high-dose therapy for patients with SCLC should be administered as part of an approved research protocol.

### **RATIONALE FOR DOSE-INTENSIVE THERAPY IN SCLC**

The principles of dose and combination therapy are strongly supported by preclinical and clinical evidence. Increased dose intensity of certain chemotherapeutic agents has greater cytotoxicity against the overall tumor cell population and is more likely to kill drug-resistant tumor cells. Which agents are chosen depends on pharmacology/mode of action and schedule/dose relationships to cytotoxicity. For these reasons, alkylating agents usually form the backbone of most high-dose regimens, because near log-linear dose-response relationships are consistently demonstrated for the alkylating agents and radiation in preclinical *in vitro* and *in vivo* experiments.<sup>1-4</sup> Clinical success requires eradication of all clonogenic tumor if solely cytotoxic strategies are employed. The kinetics of tumor regrowth (Gompertzian model) suggests that near-eradication might yield fairly similar clinical outcomes compared with more modest antitumoral effects delivered over longer periods. The ability to detect clinical benefits from high-dose therapy would be greatest in clinical settings with high risk of systemic relapse but low tumor burden. Increased cytotoxicity may be unimportant if tumor burden is great. Chemosensitivity, particularly the shape of the dose-response relationship for the drug-resistant tumor cell subpopulations, is also critical. Dose escalation of agents inactive against a particular disease is not a likely strategy to generate significant clinical success.

Many established chemotherapeutic agents—including etoposide or teniposide, cisplatin or carboplatin, ifosfamide, cyclophosphamide, vincristine, and doxo-

rubicin—have major activity against SCLC. Many of these agents, particularly the oxazaphosphorines and the platinum, have strong preclinical rationales for dose escalation. There is also extensive clinical evidence to support a dose-response relationship with these agents against a variety of tumor types, including SCLC. The major controversy surrounding dose-intensive therapy is whether this increase in tumor response can translate into prolonged survival and whether this benefit can outweigh the enhanced toxicities generated. Methods to deliver dose-intensive therapy include shortening cycle length, increasing dose and/or number of agents over multiple cycles, or increasing dose as consolidation of clinical response.

Upon review of the phase 2 trials evaluating high-dose therapy with hematopoietic cellular support, outcomes are frequently better than those reported by conventional-dose approaches. However, patient selection (low patient comorbidity) and staging biases clearly contribute to these results. Even if randomized data support the use of high-dose therapy, one may still ask whether the benefit is generalizable to the entire population of patients with that disease and/or stage of disease, or if the treatment strategy is applicable only for the best of the best. In most cases, if the treatment is deemed worthwhile, technological advances in supportive therapy will develop to increase feasibility.

A further question concerning dose-intensive strategies is whether they can be combined with other modalities. For example, dose-intensive therapy does improve overall response and complete response rates. Therefore, this approach may serve as a suitable foundation to generate minimal residual tumor burdens and potentially render other therapeutic strategies more effective. The use of combinations of treatment modalities becomes more compelling given the generic properties of tumors, namely plasticity, adaptability, and heterogeneity.

### CONVENTIONAL-DOSE THERAPY IN SCLC

Approximately 15%–20% of all bronchogenic carcinomas, small cell lung cancers are the fourth leading cause of death from cancer in both men and women in the United States.<sup>5</sup> Systemic metastatic disease is present in almost all patients at diagnosis: overt in two thirds (extensive-stage disease [ED]) and subclinical in one third (limited-stage disease [LD]). Established chemotherapeutic agents include etoposide, cisplatin, carboplatin, ifosfamide, cyclophosphamide, vincristine, and doxorubicin. Consensus conventional-dose treatment consists of 4–6 cycles of platinum/etoposide alone for ED or with concurrent chest radiation therapy for LD.<sup>6</sup> Complete response rates are 50%–70% for LD patients and 10%–20% for ED patients. By 2 years, however, 20%–40% of LD patients and <5% of ED patients remain alive<sup>7,8</sup>; 5-year survival is about half that. Although ifosfamide improved survival in ED patients in conjunction with cisplatin and etoposide,<sup>9</sup> this lead has not been tested in LD patients. New agents with promising activity include the taxanes,

gemcitabine, and the topoisomerase I inhibitors. The role of these new agents are being evaluated in ongoing first-line therapy trials. The underlying cardiovascular and pulmonary comorbidity, median age of 60–65 years, and enhanced risk of secondary smoking-related malignancies inherent in lung cancer patients contribute to an increased risk when applying dose-intensive therapy.

### **Dose Intensity: Without Cellular Support**

Klasa et al.<sup>10</sup> analyzed dose intensity (expressed in drug dose administered per square meter per week) of individual agents or regimens delivered in ED SCLC trials. Higher dose intensities of cyclophosphamide and doxorubicin with vincristine (CAV) and with etoposide (CAE), but not etoposide and cisplatin (EP), were associated with a longer median survival. The relative range of doses administered and the response and survival advantages were small.<sup>10</sup>

Six randomized trials have evaluated dose intensity in ED SCLC with or without cytokine support.<sup>11–16</sup> The actual delivered doses, when reported, were significantly less different between the arms than the planned dose intensity differences (1.2- to 2-fold). Two of these trials showed a modest survival advantage for the higher-dose therapy. Arriagada et al.<sup>17</sup> treated LD patients with 6 cycles of conventional-dose chemotherapy wherein the first cycle only was randomly assigned conventional dose vs. modest intensification. A complete response and survival advantage for the patients receiving the intensified chemotherapy was observed. This result was somewhat unexpected, since the relative difference in the two groups was so small. It is possible that dose intensity, particularly if given early in the course of treatment, may be more effective in the LD rather than the ED setting. Early intensification and treatment of earlier-stage disease are two themes to consider when designing new trials.

Multidrug cyclic weekly therapy was designed to increase the dose intensity of treatment by taking into account the differing toxicities of the weekly agents. Early phase 2 results were promising, although patient selection effects were evident.<sup>18,19</sup> None of the randomized trials demonstrated survival benefits,<sup>20–23</sup> perhaps because of the greater morbidity, dose reductions, and delays required for the weekly schedules; thus the actual delivered dose intensities were not that different. Moreover, not only were doses and schedules varied, but so were the regimens, leading to interpretation obstacles.<sup>24</sup>

Currently established cytokines (eg, granulocyte-macrophage colony-stimulating factor [GM-CSF] and G-CSF) were able to maintain dose intensity across multiple cycles.<sup>25</sup> Fukuoka et al.<sup>26</sup> documented a statistically significant survival advantage for the use of G-CSF to support the CODE (cyclophosphamide, vincristine, doxorubicin, and etoposide) regimen (59 vs. 32 weeks). With cytokine use, a modest increment in dose intensity, limited by cumulative thrombocytopenia, can



be achieved (1.5- to 2-fold). The effectiveness of various thrombopoietins or other cytokines to increase achievable dose intensity remains uncertain.

### **Dose Intensity: With Cellular Support**

Trials reported before 1995 of patients with SCLC undergoing autologous bone marrow transplantation were reviewed by Elias and Cohen<sup>27</sup> if specifics about their response status (relapsed or refractory, untreated, or responding to first-line chemotherapy [partial or complete response]) and their extent of disease (LD or ED) had been provided. Patients in these various categories were pooled for aggregated relapse-free and overall survival characteristics.

Complete and overall responses in 52 patients with relapsed or refractory disease were 19% and 56%,<sup>28-41</sup> but lasted only 2-4 months. Although combination chemotherapy, especially regimens containing multiple alkylating agents, produced slightly higher response rates, these regimens were more toxic (18% vs. 6% deaths). The high complete-response rate substantiated a dose-response relationship but was insufficient for cure.

Complete and overall responses in 103 patients with untreated SCLC (71% limited disease) who received single- or double-cycle high-dose therapy as initial treatment were 42% and 84%, respectively.<sup>42-48</sup> Relapse-free, 2-year, and overall survival rates were comparable to treatment with conventional multicycle regimens. Transplantation in the newly diagnosed SCLC setting is potentially hazardous because of the frequency of life-threatening complications from uncontrolled disease and the likelihood of tumor cell contamination in untreated autografts. Theoretically, early intensification may have greater impact on the disease.

High-dose chemotherapy with autologous hematopoietic support has been given to approximately 466 patients in response to first-line chemotherapy as consolidation.<sup>49-68</sup> About 40%-50% of partial responders converted to complete response, but without durable effect. Of patients with limited disease in complete response at the time of high-dose therapy, about 35% remained progression free at a median follow-up of >3 years at the time of publication.

Brugger and colleagues<sup>64,65</sup> administered 2 cycles of mobilization chemotherapy to 18 LD patients. Thirteen (72%) received high-dose ICE with epirubicin as consolidation. Event-free survival was 56% (median follow-up, 44 months). About 25% had stage I or II SCLC, and surgical resection was performed in 7 patients. PBPCs collected after the second cycle of mobilization chemotherapy contained no microscopic tumor cells as measured by immunocytochemistry using keratin and EMA-125 antibodies.

At the Dana-Farber Cancer Institute and Beth Israel Deaconess Medical Center, more than 55 patients with limited-stage and more than 30 with extensive-stage SCLC have been treated with high-dose combination alkylating agents (high-dose

CBP or ICE) following response to conventional-dose induction therapy. Of the original cohort of 36 limited-stage SCLC (stage IIIA or B), 29 were in or near CR before treatment with high-dose CBP with bone marrow and PBPC support followed by chest and prophylactic cranial radiotherapy.<sup>62,66</sup> For this group, the 5-year event-free survival is 53% (range of follow-up, 40 months to 11 years). By multivariate analysis, response to induction was most important (CR or near CR best vs. PR), but short induction (<4 cycles) and the use of ifosfamide during induction also impart better prognosis. Of the ED patients, 17% remain progression free >2 years after high-dose therapy, largely patients with oligometastatic disease.

Humblet et al.<sup>60</sup> performed the only randomized trial to be reported. Five cycles of conventional chemotherapy with prophylactic cranial irradiation were given to 101 patients with SCLC. Of these, 45 were randomized to 1 further cycle of either high- or conventional-dose therapy using cyclophosphamide, etoposide, and carmustine.<sup>60</sup> Dose response was demonstrated. Complete response was achieved in 77% of partial responders after high-dose therapy, but in none after conventional-dose treatment. High-dose therapy enhanced disease-free survival and tended to improve survival. However, since overall outcomes were mediocre, with an 18% toxic death rate on the high-dose arm, the investigators concluded that dose-intensive therapy should not be considered a standard therapy in SCLC. Almost all patients recurred in the chest, reflecting the fact that chest radiotherapy was not given in this trial.

Sites of prior tumor involvement are most likely to be sites of first relapse because of the greater tumor burden, drug-resistant clones in the chest, poorer drug delivery, intratumoral resistance factors such as hypoxia in areas of bulk tumor, or in the case of autograft contamination, the possibility of homing with microenvironmental support for the tumor in local-regional sites.<sup>48,56</sup> Using 50 Gy radiotherapy with conventional-dose therapy, chest relapse is reduced from 90% to 60%. Thus, high-dose curative treatment approaches should include radiotherapy to sites of bulk disease.

In many of the older trials, doses were attenuated and treatment-related morbidity and mortality were higher than currently expected. Many trials employed either single high-dose chemotherapeutic agents (plus low-dose agents),<sup>47–52,67,68</sup> or single alkylating agents.<sup>44,47,54–57</sup> Combination alkylating agents were employed in a minority of patients.<sup>29,32,38,43,58–66</sup>

## FUTURE DIRECTIONS

### Intensify Involved Field Radiotherapy

Thoracic radiotherapy provides a 25%–30% improvement in local-regional control and a 5% increase in long-term progression-free survival for limited-stage

SCLC.<sup>69,70</sup> Local-regional relapse still remains high (~60% actuarial risk of local relapse by 3 years) with the typical 45–50 Gy TRT<sup>71–73</sup> and may be underestimated because of the competing risk of systemic relapse.<sup>74</sup> Further enhancement of local-regional control might increase the proportion of long-term survivors.

Dose intensity of chest radiotherapy has not been sufficiently studied. The Eastern Cooperative Oncology Group and the Radiation Therapy Oncology Group compared 45-Gy TRT given either daily over 5 weeks or twice a day over 3 weeks concurrent with cisplatin and etoposide chemotherapy.<sup>75</sup> Tumor recurrence in the chest was reduced from 61% to 48% at 2 years with the more intense TRT. A survival advantage for the more-intensive radiotherapy has been reported.<sup>76</sup> Many investigators have pointed to this trial as establishing a new benchmark for SCLC treatment outcomes. However, as in high-dose trials, a patient selection bias is evident. Patients who were too sick (not suited for up-front combined modality therapy) or who had bilateral bulky mediastinal adenopathy (too large a radiotherapy port) were not generally enrolled onto the trial. Thus, a full 40% of patients enrolled in this trial had no apparent mediastinal adenopathy on computerized tomography, distinctly unusual for SCLC populations. This observation in no way undermines the demonstrated benefit of more intense radiotherapy, but caution is required in applying this advance to the general population of SCLC.

Using a shrinking-field technique, Choi et al.<sup>77</sup> gave escalating doses of TRT concurrently with cisplatin and etoposide either as daily 180-cGy fractions or as twice-a-day 150 cGy fractions in LD SCLC. The maximal tolerated doses defined by acute esophagitis were 45 Gy for twice-a-day administration and >70 Gy for daily administration. Intensification of TRT dose is feasible and should be evaluated in a randomized setting. Since most relapses occur in-field, a more focused port may be feasible to reduce morbidity of more intense TRT.

### **Intensify Induction**

Induction therapy may reduce tumor burden, stabilize rapidly progressive systemic and local symptoms from SCLC, select patients possessing chemosensitive tumors for subsequent intensification, and diminish micrometastases in the autograft sources, as discussed below. On the other hand, chemoresistant tumor cells might proliferate or even be induced across treatment, and may outweigh these advantages. The Arriagada trial supports initial intensification of induction.<sup>17</sup> A logical extension of this concept is the administration of multicycle dose-intensive combination therapies supported by cytokines and PBPCs.<sup>78–85</sup> Pettengell et al.<sup>80</sup> treated good-performance-status SCLC patients with conventional-dose ICE supported by autologous whole blood cells given on day 3 of chemotherapy for 6 cycles. Cycle length could be shortened to 2 weeks using either pheresis products or 750 cc whole blood stored at 4°C. Cycles were repeated upon platelet

recovery to 30,000/ $\mu$ L, rather than the usual 100,000/ $\mu$ L. In this phase 1 trial of 25 patients, the full planned dose intensity for each of the arms was reached across the first 3 cycles, and 56% of patients completed all 6 cycles. Mortality was 12%, and complete response rate was 64%. The authors noted that the collection of whole blood without cryopreservation substantially reduced the cost and complexity of cellular support for nonablative therapy.<sup>80</sup> In a subsequent randomized phase 2 study, 50 “good prognosis” patients were given ICE every 2 or 4 weeks.<sup>79</sup> The median dose intensity delivered over the first 3 cycles was 1.8 (0.99–1.97) vs. 0.99 (0.33–1.02) on the 2-week vs. 4-week cycles, respectively. Paradoxically, more hematopoietic and infectious events occurred on the standard-dose 4-week arm. A phase 3 trial is ongoing.

In the European Group for Blood and Marrow Transplantation, 47 patients underwent mobilization with epirubicin and G-CSF followed by 3 cycles of moderately intensive ICE.<sup>81</sup> Radiation to chest and head was recommended. Of 35 evaluable patients, the complete and near-complete response rate was 69%. Mortality was 14%. A phase 3 trial is ongoing.

Using an innovative trial design, Humblet et al.<sup>85</sup> treated 37 limited-stage patients with 4 intensive alternating cycles of etoposide with either ifosfamide or carboplatin with stem cell support. To integrate early chest radiotherapy, bursts of 10 Gy TRT in 5 fractions were given concurrently with each chemotherapy administration (total dose, 40 Gy). Mortality was 3%. The median event-free survival was 18 months, and 80% remain alive at 30 months. Eight of 13 relapses occurred in the brain, perhaps because no PCI was given.

### **Minimal Residual Tumor/Autograft Involvement**

Autograft contamination by tumor cells may cause relapse. Gene marking studies have definitively proven that residual tumor cells do directly contribute to relapse in certain hematologic malignancies and neuroblastoma (verbal communication, Stem Cell Conference, San Diego, March, 1993),<sup>86–88</sup> although the concept has not been adequately tested in solid tumors.<sup>89</sup> These cells also serve to indicate that the patient has increased systemic chemotherapy-resistant tumor burden.

In SCLC, the marrow is a common metastatic site. Subclinical micrometastatic disease is detected in marrow in 13%–54% of newly diagnosed limited-stage and 44%–77% of newly diagnosed extensive-stage SCLC<sup>90–94</sup> using immunohistochemical techniques with sensitivities of  $\sim 1$  in  $10^4$  cells. Two thirds of patients in CR may have subclinical disease in marrow,<sup>95,96</sup> and residual tumor appears to predict relapse.<sup>96</sup> Brugger et al.<sup>97</sup> detected circulating tumor cells in patients with metastatic SCLC or breast cancer mobilized with G-CSF and IPE (ifosfamide, cisplatin, and etoposide) chemotherapy, but not after the second cycle of chemotherapy. In the short term, *in vivo* chemotherapy induction may purge the

patient and the autologous stem cell source.<sup>67</sup> In our unpublished data using a technique with a sensitivity of 1–10 in 10<sup>6</sup>, up to 77% of LD patients in or near complete response before high-dose therapy have detectable tumor cells in their marrow by keratin staining.<sup>98</sup>

Molecular and antigenic characterization of these residual cancer cells may guide strategies for further treatment. We are using a fluorescence microscope with automated computerized scanning with one set of fluorescent probes for detection and a second set with different fluorophores for biologic characterization to analyze patterns of coexpression of various markers in these cells.<sup>98</sup> Prospective trials to determine the clinical significance of marrow or peripheral blood tumor contamination and the impact of novel stem cell sources to support high-dose therapy are underway.

## CONCLUSIONS

Two major complementary strategies to administer high-dose therapy for SCLC include dose-intensive multicycle approach as initial treatment and the “later” intensification in responders. Advantages for each approach are evident. The multicycle approach can achieve early dose intensity and maintain it for about 3–4 cycles. Disadvantages to this approach include subtransplant doses, high mortality rates, late administration of chest radiotherapy (except for the recent trial of Humblet et al.), and the collection of stem cells early in treatment when they have a higher potential to be contaminated with tumor cells. Advantages to later intensification include a patient with decreased tumor burden and tumor-related symptoms with consequent improved performance status and a partial purge of the autograft. Early dose-intensive thoracic radiotherapy can be given before high-dose therapy. The drawback of later administration of the dose-intensive cycle can be surmounted in part by intensification and shortening of induction chemoradiotherapy. The optimum may be to merge the two strategies into one: a brief dose-intensive induction followed by a single or double cycle of stem cell-supported therapy followed by TRT and PCI. Ultimately, a randomized trial in patients with limited comorbid disease will be necessary to determine whether the increased toxicity is worthwhile and for which subsets of patients this approach is curative.

High-dose therapy has a strong scientific basis: it kills more tumor cells and achieves minimal tumor burden in most patients. In clinical situations in which toxicity has been acceptable, it typically results in prolonged progression-free survival in a subset of patients. An additional group of patients may be near cure. High-dose therapy may have increased value if additional targets of residual tumor cells can be identified for novel treatment strategies and modalities. Most biologic strategies, such as active or adoptive immunotherapy, gene function replacement (retinoblastoma gene and/or *p53*), or interruption of autocrine or paracrine growth loops, work best against minimal tumor burden.

## REFERENCES

1. Teicher BA. Preclinical models for high-dose therapy. In: Armitage JO, Antman KH, eds. *High-Dose Cancer Therapy: Pharmacology, Hematopoietins, Stem Cells*. Baltimore, MD: Williams and Wilkins, 1992, p. 14–42.
2. Frei E III. Combination cancer chemotherapy: presidential address. *Cancer Res* 32: 2593–2607, 1972.
3. Frei III E, Canellos GP. Dose, a critical factor in cancer chemotherapy. *Am J Med* 69:585–594, 1980.
4. Frei E III, Antman KH. Combination chemotherapy, dose, and schedule: section XV, principles of chemotherapy. In: Holland JF, Frei E III, Bast RC Jr, Kufe DW, Morton DL, Weichselbaum RR, eds. *Cancer Medicine*. Philadelphia, PA: Lea and Febiger, 1993, p. 631–639.
5. Boring CC, Squires TS, Tong TT. Cancer Statistics, 1993. *CA Cancer J Clin* 44:19–51, 1994.
6. Johnson DH, Kim K, Sause W, et al. Cisplatin and etoposide plus thoracic radiotherapy administered once or twice daily in limited stage small cell lung cancer: final report of intergroup trial 0096 [abstract]. *Proc ASCO* 15:374, 1996. Abstract 1113.
7. Seifter EJ, Ihde DC. Therapy of small cell lung cancer: a perspective on two decades of clinical research. *Semin Oncol* 15:278–299, 1988.
8. Osterlind K, Hansen HH, Hansen M, Dombernowsky P, Andersen PK. Long-term disease-free survival in small-cell carcinoma of the lung: a study of clinical determinants. *J Clin Oncol* 4:1307–1313, 1986.
9. Loehrer PJ, Ansari R, Gonin R, et al. Cisplatin plus etoposide with and without ifosfamide in extensive small-cell lung cancer: a Hoosier Oncology Group study. *J Clin Oncol* 13: 2594–2599, 1995.
10. Klasa RJ, Murray N, Coldman AJ. Dose-intensity meta-analysis of chemotherapy regimens in small-cell carcinoma of the lung. *J Clin Oncol* 9:499–508, 1991.
11. Cohen MH, Creaven PJ, Fossieck BE, et al. Intensive chemotherapy of small cell bronchogenic carcinoma. *Cancer Treat Rep* 61:349–354, 1977.
12. Brower M, Ihde DC, Johnston-Early A, et al. Treatment of extensive stage small cell bronchogenic carcinoma: effects of variation in intensity of induction chemotherapy. *Am J Med* 75:993–1000, 1983.
13. Johnson DH, Einhorn LH, Birch R, et al. A randomized comparison of high-dose versus conventional-dose cyclophosphamide, doxorubicin, and vincristine for extensive-stage small-cell lung cancer: a phase III trial of the Southeastern Cancer Study Group. *J Clin Oncol* 5:1731–1738, 1987.
14. Mehta C, Vogl SE. High-dose cyclophosphamide in the induction therapy of small cell lung cancer: minor improvements in rate of remission and survival. *Proc AACR* 23:155, 1982.
15. Figueredo AT, Hryniuk WM, Strautmanis I, et al. Co-trimoxazole prophylaxis during high-dose chemotherapy of small-cell lung cancer. *J Clin Oncol* 3:54–64, 1985.
16. Ihde DC, Mulshine JL, Kramer BS, et al. Prospective randomized comparison of high-dose and standard-dose etoposide and cisplatin chemotherapy in patients with extensive-stage small-cell lung cancer. *J Clin Oncol* 12:2022–2034, 1994.

17. Arriagada R, Le Chevalier T, Pignon J-P, et al. Initial chemotherapeutic doses and survival in patients with limited small-cell lung cancer. *N Engl J Med* 329:1848–1852, 1993.
18. Miles DW, Earl HM, Souhami RL, et al. Intensive weekly chemotherapy for good-prognosis patients with small-cell lung cancer. *J Clin Oncol* 9:280–285, 1991.
19. Murray N, Gelmon K, Shah A, et al. Potential for long-term survival in extensive stage small-cell lung cancer (ESCLC) with CODE chemotherapy and radiotherapy [abstract]. *Lung Cancer* 11 (Suppl 1):99, 1994. Abstract 377.
20. Furuse K, Kubota K, Nishiwaki Y, et al. Phase III study of dose intensive weekly chemotherapy with recombinant human granulocyte-colony stimulating factor (G-CSF) versus standard chemotherapy in extensive stage small cell lung cancer (SCLC) [abstract]. *Proc ASCO* 15:375, 1996. Abstract 1117.
21. Murray N, Livingston RB, Shepard FA, et al. Randomized study of CODE versus alternating CAV/EP for limited stage small cell lung cancer: an Intergroup Study of the National Cancer Institute of Canada Clinical Trials Group and the Southwest Oncology Group. *J Clin Oncol* 17:2300–2308, 1999.
22. Sculier JP, Paesmans M, Bureau G, et al. Multiple drug weekly chemotherapy versus standard combination regimen in small cell lung cancer: a phase III randomized study conducted by the European Lung Cancer Working Party. *J Clin Oncol* 11:1858–1865, 1993.
23. Souhami RL, Rudd R, Ruiz de Elvira MC, et al. Randomized trial comparing weekly versus 3-week chemotherapy in small cell lung cancer: a Cancer Research Campaign trial. *J Clin Oncol* 12:1806–1813, 1994.
24. Johnson DH, Carbone DP. Increased dose-intensity in small cell lung cancer: a failed strategy [editorial]. *J Clin Oncol* 17:2297–2299, 1999.
25. Crawford J, Ozer H, Stoller R, et al. Reduction by granulocyte colony-stimulating factor of fever and neutropenia induced by chemotherapy in patients with small-cell lung cancer. *N Engl J Med* 325:164–170, 1991.
26. Fukuoka M, Masuda N, Negoro S, et al. CODE chemotherapy with or without granulocyte colony-stimulating factor in small-cell lung cancer. *Br J Cancer* 75:306–309, 1997.
27. Elias A, Cohen BF. Dose intensive therapy in lung cancer. In: Armitage JO, Antman KH, eds. *High-Dose Cancer Therapy: Pharmacology, Hematopoietins, Stem Cells*. 2nd ed. Baltimore, MD: Williams and Wilkins, 1995, p. 824–846. Chapter 45.
28. Phillips GL, Fay JW, Herzig GP, et al. Nitrosourea (BCNU), NSC #4366650 and cryopreserved autologous marrow transplantation for refractory cancer: a phase I-II study. *Cancer* 52:1792–1802, 1983.
29. Stahel RA, Takvorian RW, Skarin AT, Canellos GP. Autologous bone marrow transplantation following high-dose chemotherapy with cyclophosphamide, BCNU, and VP-16 in small cell carcinoma of the lung and a review of current literature. *Eur J Cancer Clin Oncol* 20:1233–1238, 1984.
30. Wolff SW, Fer MF, McKay CM, et al. High-dose VP-16-213 and autologous bone marrow transplantation for refractory malignancies: a phase I study. *J Clin Oncol* 1:701–705, 1983.
31. Pico JL, Beaujean F, Debre M, et al. High dose chemotherapy (HDC) with autologous bone marrow transplantation (ABMT) in small cell carcinoma of the lung (SCCL) in relapse. *Proc ASCO* 2:206, 1983.

32. Pico JL, Baume D, Ostronoff M, et al. Chimiotherapie à hautes doses suivie d'autogreffe de moelle osseuse dans le traitement du cancer bronchique a petites cellules. *Bull Cancer* 74:587–595, 1987.
33. Postmus PE, Mulder NH, Elema JD. Graft versus host disease after transfusions of non-irradiated blood cells in patients having received autologous bone marrow: a report of 4 cases following ablative chemotherapy for solid tumors. *Eur J Cancer Clin Oncol* 24:889–894, 1988.
34. Rushing DA, Baldauf MC, Gehlsen JA, et al. High-dose BCNU and autologous bone marrow reinfusion in the treatment of refractory or relapsed small cell carcinoma of the lung (SCCL). *Proc ASCO* 3:217, 1984.
35. Spitzer G, Dicke KA, Verma DS, Zander A, McCredie KB. High-dose BCNU therapy with autologous bone marrow infusion: preliminary observations. *Cancer Treat Rep* 63:1257–1264, 1979.
36. Spitzer G, Dicke KA, Latam J, et al. High-dose combination chemotherapy with autologous bone marrow transplantation in adult solid tumors. *Cancer* 45:3075–3085, 1980.
37. Eder JP, Antman K, Shea TC, et al. Cyclophosphamide and thiotepa with autologous bone marrow transplantation in patients with solid tumors. *J Natl Cancer Inst* 80:1221–1226, 1988.
38. Elias AD, Ayash LJ, Wheeler C, et al. A phase I study of high-dose ifosfamide, carboplatin, and etoposide with autologous hematopoietic stem cell support. *Bone Marrow Transplant* 15:373–379, 1995.
39. Douer D, Champlin RE, Ho WG, et al. High-dose combined-modality therapy and autologous bone marrow transplantation in resistant cancer. *Am J Med* 71:973–976, 1981.
40. Harada M, Yoshida T, Funada H, et al. Combined-modality therapy and autologous bone marrow transplantation in the treatment of advanced non-Hodgkin's lymphoma and solid tumors: the Kanawaza experience. *Transplant Proc* 14:733–737, 1982.
41. Lazarus HM, Spitzer TR, Creger RT. Phase I trial of high-dose etoposide, high-dose cisplatin, and reinfusion of autologous bone marrow for lung cancer. *Am J Clin Oncol* 13:107–112, 1990.
42. Lange A, Kolodziej J, Tomeczko J, et al. Aggressive chemotherapy with autologous bone marrow transplantation in small cell lung carcinoma. *Archiv Immunol Ther Exp* 39:431–439, 1991.
43. Nomura F, Shimokata K, Saito H, et al. High dose chemotherapy with autologous bone marrow transplantation for limited small cell lung cancer. *Jpn J Clin Oncol* 20:94–98, 1990.
44. Spitzer G, Farha P, Valdivieso M, et al. High-dose intensification therapy with autologous bone marrow support for limited small-cell bronchogenic carcinoma. *J Clin Oncol* 4:4–13, 1986.
45. Johnson DH, Hande KR, Hainsworth JD, Greco FA. High-dose etoposide as single-agent chemotherapy for small cell carcinoma of the lung. *Cancer Treat Rep* 67:957–958, 1983.
46. Littlewood TJ, Spragg BP, Bentley DP. When is autologous bone marrow transplantation safe after high-dose treatment with etoposide? *Clin Lab Haematol* 7:213–218, 1985.
47. Littlewood TJ, Bentley DP, Smith AP. High-dose etoposide with autologous bone marrow transplantation as initial treatment of small cell lung cancer: a negative report. *Eur J*



- Respir Dis* 68:370–374, 1986.
48. Souhami RL, Hajichristou HT, Miles DW, et al. Intensive chemotherapy with autologous bone marrow transplantation for small cell lung cancer. *Cancer Chemother Pharmacol* 24:321–325, 1989.
  49. Smith IE, Evans BD, Harland SJ, et al. High-dose cyclophosphamide with autologous bone marrow rescue after conventional chemotherapy in the treatment of small cell lung carcinoma. *Cancer Chemother Pharmacol* 14:120–124, 1985.
  50. Banham S, Burnett A, Stevenson R, et al. Pilot study of combination chemotherapy with late dose intensification and autologous bone marrow rescue in small cell bronchogenic carcinoma. *Br J Cancer* 42:486, 1982.
  51. Banham S, Loukop M, Burnett A, et al. Treatment of small cell carcinoma of the lung with late dosage intensification programmes containing cyclophosphamide and mesna. *Cancer Treat Rev* 10 (Suppl A):73–77, 1983.
  52. Burnett AK, Tansey P, Hills C, et al. Haematologic reconstitution following high dose and supralethal chemoradiotherapy using stored non-cryopreserved autologous bone marrow. *Br J Haematol* 54:309–316, 1983.
  53. Jennis A, Levitan N, Pecora AL, Isaacs R, Lazarus H. Sequential high dose chemotherapy (HDC) with filgrastim/peripheral stem cell support (PSCS) in extensive stage small cell lung cancer (SCLC) [abstract]. *Proc ASCO* 15:349, 1996. Abstract 1021.
  54. Ihde DC, Diesseroth AB, Lichter AS, et al. Late intensive combined modality therapy followed by autologous bone marrow infusion in extensive stage small-cell lung cancer. *J Clin Oncol* 4:1443–1454, 1986.
  55. Cunningham D, Banham SW, Hutcheon AH, et al. High-dose cyclophosphamide and VP-16 as late dosage intensification therapy for small cell carcinoma of lung. *Cancer Chemother Pharmacol* 15:303–306, 1985.
  56. Sculier JP, Klastersky J, Stryckmans P, et al. Late intensification in small-cell lung cancer: a phase I study of high doses of cyclophosphamide and etoposide with autologous bone marrow transplantation. *J Clin Oncol* 3:184–191, 1985.
  57. Klastersky J, Nicaise C, Longeval E, et al. Cisplatin, adriamycin and etoposide (CAV) for remission induction of small-cell bronchogenic carcinoma: evaluation of efficacy and toxicity and pilot study of a “late intensification” with autologous bone marrow rescue. *Cancer* 50:652–658, 1982.
  58. Cornbleet M, Gregor A, Allen S, Leonard R, Smyth J. High dose melphalan as consolidation therapy for good prognosis patients with small cell carcinoma of the bronchus (SCCB). *Proc ASCO* 3:210, 1984.
  59. Wilson C, Pickering D, Stewart S, et al. High dose chemotherapy with autologous bone marrow rescue in small cell lung cancer. *In Vivo* 2:331–334, 1988.
  60. Humblet Y, Symann M, Bosly A, et al. Late intensification chemotherapy with autologous bone marrow transplantation in selected small-cell carcinoma of the lung: a randomized study. *J Clin Oncol* 5:1864–1873, 1987.
  61. Stewart P, Buckner CD, Thomas ED, et al. Intensive chemoradiotherapy with autologous marrow transplantation for small cell carcinoma of the lung. *Cancer Treat Rep* 67: 1055–1059, 1983.
  62. Elias AD, Ayash L, Frei E III, et al. Intensive combined modality therapy for limited stage

- small cell lung cancer. *J Natl Cancer Inst* 85:559–566, 1993.
63. Tomeczko J, Pacuszko T, Napora P, Lange A. Treatment intensification which includes high dose induction improves survival of lung carcinoma patients treated by high-dose chemotherapy with hematopoietic progenitor cell rescue but does not prevent high rate of relapses. *Bone Marrow Transplant* 18 (Suppl 1):S44–S47, 1996.
  64. Brugger W, Frommhold H, Pressler K, Mertelsmann R, Kanz L. Use of high-dose etoposide/ifosfamide/carboplatin/epirubicin and peripheral blood progenitor cell transplantation in limited-disease small cell lung cancer. *Semin Oncol* 22 (Suppl 2):3–8, 1995.
  65. Brugger W, Fetscher S, Hasse J, et al. Multimodality treatment including early high-dose chemotherapy with peripheral blood stem cell transplantation in limited-disease small cell lung cancer. *Semin Oncol* 25 (Suppl 2):42–48, 1998.
  66. Elias A, Ibrahim J, Skarin AT, et al. Dose intensive therapy for limited stage small cell lung cancer: long-term outcome. *J Clin Oncol* 17:1175–1184, 1999.
  67. Farha P, Spitzer G, Valdivieso M, et al. High-dose chemotherapy and autologous bone marrow transplantation for the treatment of small cell lung carcinoma. *Cancer* 52: 1351–1355, 1983.
  68. Marangolo M, Rosti G, Ravaioli A, et al. Small cell carcinoma of the lung (SCCL): high-dose (HD) VP-16 and autologous bone marrow transplantation (ABMT) as intensification therapy: preliminary results. *Int J Cell Cloning* 3:277, 1985.
  69. Pignon JP, Arriagada R, Ihde DC, et al. A meta-analysis of thoracic radiotherapy for small-cell lung cancer. *N Engl J Med* 327:1618–1624, 1992.
  70. Warde P, Payne D. Does thoracic irradiation improve survival and local control in limited-stage small-cell carcinoma of the lung? A meta-analysis. *J Clin Oncol* 10:890–895, 1992.
  71. Perry MC, Eaton WL, Propert KJ, et al. Chemotherapy with or without radiation therapy in limited small-cell carcinoma of the lung. *N Engl J Med* 316:912–918, 1987.
  72. Bunn PA, Lichter AS, Makuch RW, et al. Chemotherapy alone or chemotherapy with chest radiation therapy in limited stage small cell lung cancer. *Ann Intern Med* 106:655–662, 1987.
  73. Kies MS, Mira JG, Crowley JJ, et al. Multimodal therapy for limited small-cell lung cancer: a randomized study of induction combination chemotherapy with or without thoracic radiation in complete responders; and with wide-field versus reduced-field radiation in partial responders: a Southwest Oncology Group study. *J Clin Oncol* 5:592–600, 1987.
  74. Arriagada R, Kramar A, Le Chevalier T, De Cremoux H. Competing events determining relapse-free survival in limited small-cell lung carcinoma. *J Clin Oncol* 10:447–451, 1992.
  75. Turrisi AT, Kim K, Johnson DH, et al. Daily (qd) v twice-daily (bid) thoracic irradiation (TI) with concurrent cisplatin-etoposide (PE) for limited small cell lung cancer (LSCLC): preliminary results on 352 randomized eligible patients [abstract]. *Lung Cancer* 11 (Suppl 1):172, 1994. Abstract 667.
  76. Turrisi AT, Kim K, Blum R, et al. Twice-daily compared with once-daily thoracic radiotherapy in limited small-cell lung cancer treated concurrently with cisplatin and etoposide. *N Engl J Med* 340:265–271, 1999.
  77. Choi NC, Herndon JE II, Rosenman J, et al. Phase I study to determine the maximum tol-

- erated dose (MTD) of radiation in standard daily and hyperfractionated accelerated twice daily radiation schedules with concurrent chemotherapy for limited stage small cell lung cancer (Cancer and Leukemia Group B 8837). *J Clin Oncol* 16:3528–3536, 1998.
78. Tepler I, Cannistra SA, Frei E III, et al. Use of peripheral blood progenitor cells abrogates the myelotoxicity of repetitive outpatient high-dose carboplatin and cyclophosphamide chemotherapy. *J Clin Oncol* 11:1583–1591, 1993.
  79. Woll PJ, Lee SM, Lomax L, et al. Randomised phase II study of standard versus dose-intensive ICE chemotherapy with reinfusion of haemopoietic progenitors in whole blood in small cell lung cancer (SCLC) [abstract]. *Proc ASCO* 15:333, 1996. Abstract 957.
  80. Pettengell R, Woll PJ, Thatcher N, Dexter TM, Testa NG. Multicyclic, dose-intensive chemotherapy supported by sequential reinfusion of hematopoietic progenitors in whole blood. *J Clin Oncol* 13:148–156, 1995.
  81. Perey L, Rosti G, Lange A, et al. Sequential high-dose ICE chemotherapy with circulating progenitor cells (CPC) in small cell lung cancer: an EBMT study. *Bone Marrow Transplant* 18 (Suppl 1):S40–S43, 1996.
  82. Crown J, Wasserheit C, Hakes T, et al. Rapid delivery of multiple high-dose chemotherapy courses with granulocyte colony-stimulating factor and peripheral blood-derived hematopoietic progenitor cells. *J Natl Cancer Inst* 84:1935–1936, 1992.
  83. Gianni AM, Siena S, Bregni M, et al. Prolonged disease-free survival after high-dose sequential chemo-radiotherapy and hemopoietic autologous transplantation in poor prognosis Hodgkin's disease. *Ann Oncol* 2:645–653, 1991.
  84. Ayash L, Elias A, Wheeler C, et al. Double dose-intensive chemotherapy with autologous marrow and peripheral blood progenitor cell support for metastatic breast cancer: a feasibility study. *J Clin Oncol* 12:37–44, 1994.
  85. Humblet Y, Bosquee L, Weynants P, Symann M. High-dose chemo-radiotherapy cycles for LD small cell lung cancer patients using G-CSF and blood stem cells. *Bone Marrow Transplant* 18 (Suppl 1):S36–S39, 1996.
  86. Gribben JG, Freedman AS, Neuberg D, et al. Immunologic purging of marrow assessed by PCR before autologous bone marrow transplantation for B-cell lymphoma. *N Engl J Med* 325:1525–1533, 1991.
  87. Brenner MK, Rill DR, Moen RC, et al. Gene-marking to trace origin of relapse after autologous bone-marrow transplantation. *Lancet* 341:85–86, 1993.
  88. Brenner MK, Rill DR. Gene marking to improve the outcome of autologous bone marrow transplantation. *J Hematother* 3:33–36, 1994.
  89. O'Shaughnessy JA, Cowan KH, Cottler-Fox M, et al. Autologous transplantation of retrovirally-marked CD34-positive bone marrow and peripheral blood cells in patients with multiple myeloma or breast cancer [abstract]. *Proc ASCO* 13:296, 1994. Abstract 963.
  90. Stahel RA, Mabry M, Skarin AT, Speak J, Bernal SD. Detection of bone marrow metastasis in small-cell lung cancer by monoclonal antibody. *J Clin Oncol* 3:455–461, 1985.
  91. Canon JL, Humblet Y, Lebacqz-Verheyden AM, et al. Immunodetection of small cell lung cancer metastases in bone marrow using three monoclonal antibodies. *Eur J Cancer Oncol* 24:147–150, 1988.
  92. Trillet V, Revel D, Combaret V, et al. Bone marrow metastases in small cell lung cancer: detection with magnetic resonance imaging and monoclonal antibodies. *Br J Cancer* 60:

- 83–88, 1989.
93. Berendsen HH, De Leij L, Postmus PE, Ter Haar JG, Popperna S, The TH. Detection of small cell lung cancer metastases in bone marrow aspirates using monoclonal antibody directed against neuroendocrine differentiation antigen. *J Clin Pathol* 41:273–276, 1988.
  94. Beiske K, Myklebust AT, Aamdal S, Langhom R, Jakobsen E, Fodstad O. Detection of bone marrow metastases in small cell lung cancer patients. *Am J Pathol* 141:531–538, 1992.
  95. Hay FG, Ford A, Leonard RCF. Clinical applications of immunocytochemistry in the monitoring of the bone marrow in small cell lung cancer (SCLC). *Int J Cancer* 42 (Suppl 2): 8–10, 1988.
  96. Leonard RCF, Duncan LW, Hay FG. Immunocytological detection of residual marrow disease at clinical remission predicts metastatic relapse in small cell lung cancer. *Cancer Res* 50:6545–6548, 1990.
  97. Brugger W, Bross KJ, Glatt M, Weber F, Mertelsmann R, Kanz L. Mobilization of tumor cells and hematopoietic progenitor cells into peripheral blood of patients with solid tumors. *Blood* 83:636–640, 1994.
  98. Elias A, Li Y, Wheeler C, et al. CD34-selected peripheral blood progenitor cell (PBPC) support in high dose therapy of small cell lung cancer (SCLC): use of a novel detection method for minimal residual tumor (MRT) [abstract]. *Proc ASCO* 15: 341, 1996. Abstract 991.

# **High-Dose Chemotherapy for Germ Cell Tumors: The European Point of View**

***Giovanni Rosti, Patrizia Ferrante, Ugo De Giorgi, Helen Baldomero,  
Anna Cariello, Giorgio Papiani, Maurizio Marangolo***

*Department of Oncology and Hematology (G.R., P.F., U.D.G., A.C., G.P., M.M.),  
Ospedale Civile, Ravenna, Italy; University of Basel (H.B.), Basel, Switzerland*

## **ABSTRACT**

High-dose chemotherapy for germ cell tumors is alive and well in Europe, with more than 300 patients treated each year. The mortality rate in 1999 was 3%, and the majority of patients received peripheral blood progenitor cells (PBPCs) as hematologic support. Several phase 2 studies and an overview have shown that patients with sensitive disease are the best candidates to achieve long-term survival. A phase 3 randomized study (IT-94) is approaching its final accrual (280 patients). It will be the first study addressing the role of high-dose chemotherapy in this disease.

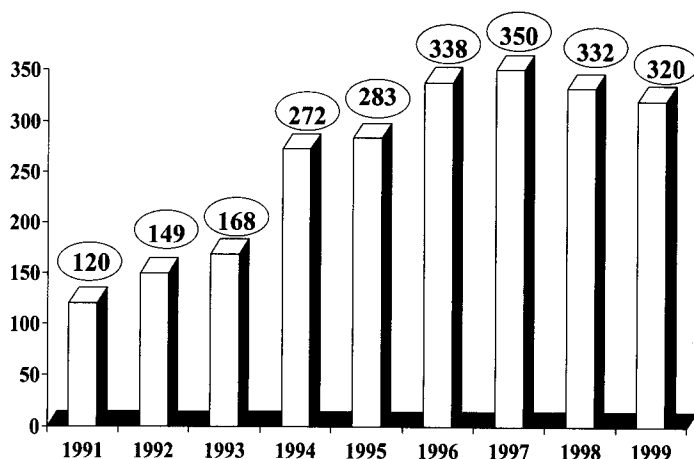
## **INTRODUCTION**

The outcome of advanced germ cell tumors is extremely good compared with that of other solid tumors.<sup>1</sup> Nevertheless, patients in relapse after previous complete remission (CR) and those not achieving CR with first-line therapy have a very dismal prognosis.

High-dose chemotherapy treatments for germ cell tumors started in the early 1980s as a modality to circumvent drug resistance, the ultimate cause of treatment failure. The clinical and biological characteristics of possible candidates for intensified treatment include young age, clinical good condition, rare bone marrow involvement, and sensitivity to major drugs even after relapse. This article reports the present situation in Europe in this field.

## **THE EUROPEAN SURVEY AND THE EBMT SOLID TUMORS REGISTRY**

Despite the fact that germ cell (testicular or extragonadal) cancers represent a small minority among adult solid tumor types, the number of patients receiving an autograft recently has been high.

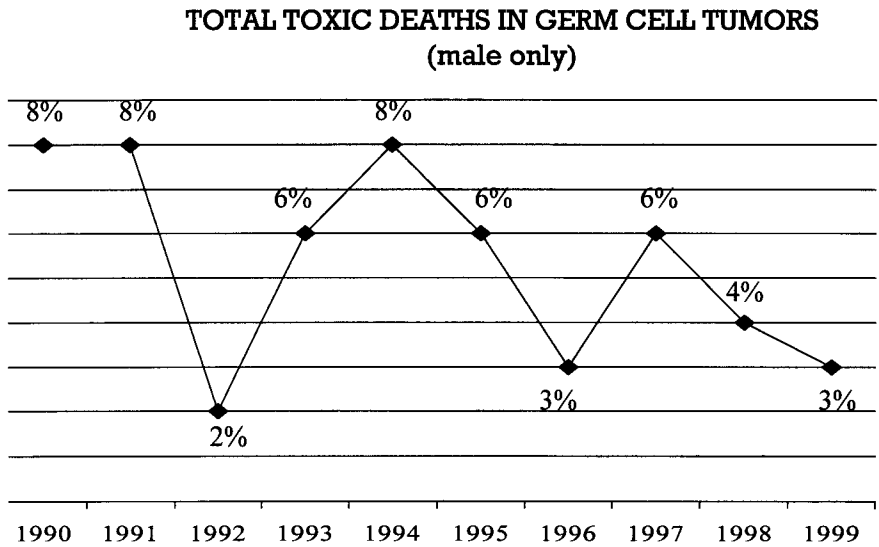


**Figure 1.** High-dose chemotherapy for germ cell tumors in Europe. Source: European Group for Blood and Marrow Transplantation survey.

Figure 1 shows the number of patients (1 patient = 1 graft) during the last 9 years in Europe. In the last few years, a plateau has emerged, with 320–350 cases per year, and we can foresee that it will not increase in the future. The majority of transplanted patients are currently reported to the European Group for Blood and Marrow Transplantation (EBMT) Solid Tumors Registry.<sup>2</sup> By March 2000, a total of 1465 cases were included: 691 (47%) in relapse or progression, 574 (39%) as consolidation; for 200 (14%), disease status at graft has not been reported and a careful data request is underway.

The majority of relapsing patients (429 of 691) are in sensitive relapse; 1366 are male; the mean age is  $30 \pm 9$  years, median age 30 years (range, 1–63 years). Only 89 patients were <18 years old. More than 90% of these patients received PBPCs as the sole source of hematopoietic support in 1998 and 1999, after the shift from autologous bone marrow transplantation (autoBMT) to PBPC beginning in 1993. Toxic death rate (any death within the first 100 days from graft, not directly related to the disease) has been dramatically reduced to 3% (Figure 2), which is not higher than reported with major standard-dose regimens.<sup>3</sup> Among 122 female patients with germ cell tumors, the toxic death rate was 7% (data not shown).

Of the patients, 1068 received 1 autotransplant; 237 had 2 grafts; and 61 had 3 or more grafts. Mean days with polymorphonuclear cells (PMN)  $<500 \mu\text{L}$  were  $19 \pm 18$  (median, 17; range, 7–68) and  $12 \pm 7$  (median, 11; range, 1–70) for autoBMT and PBPCs, respectively. The median values for thrombocytopenia (platelets  $<50,000/\mu\text{L}$ ) were  $25 \pm 19$  and  $21 \pm 18$  days, respectively.



**Figure 2.** Toxic death rate (at 100 days after graft) for germ cell tumors. Source: European Group for Blood and Marrow Transplantation database.

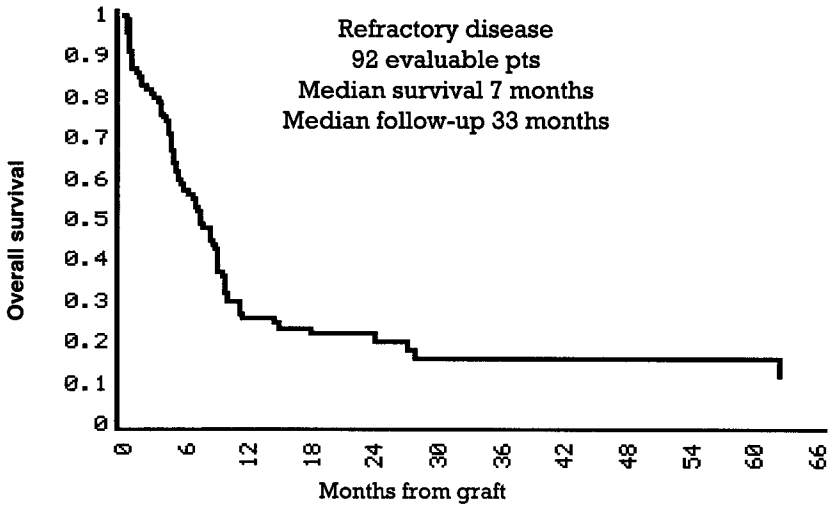
## RESULTS

Ninety-two evaluable patients were treated with high-dose chemotherapy for refractory disease and have a median survival of only 7 months (Figure 3). Much better results have been obtained in patients with sensitive relapse at the time of transplant (second complete responses are excluded in the analysis reported in Figure 4). Those data are in accordance with a recent survey from 4 major European and US centers<sup>4</sup> showing that status at transplant is one of the most significant prognostic factors affecting survival.

In a recent report of 37 patients from the Netherlands,<sup>5</sup> patients relapsing after standard chemotherapy have a 44-month median overall survival; our group<sup>6</sup> has presented similar data with a smaller cohort of patients and a different high-dose schedule. Despite several phase 2 studies published in the past decade of high-dose chemotherapy for relapsing<sup>5,6</sup> or poor-risk<sup>7</sup> patients, autotransplantation had been considered experimental therapy. Although a matched-pair analysis from Germany and Norway<sup>8</sup> suggests a benefit from high-dose therapy in ~10% (perhaps lower than expected), the final word should come from randomized studies.

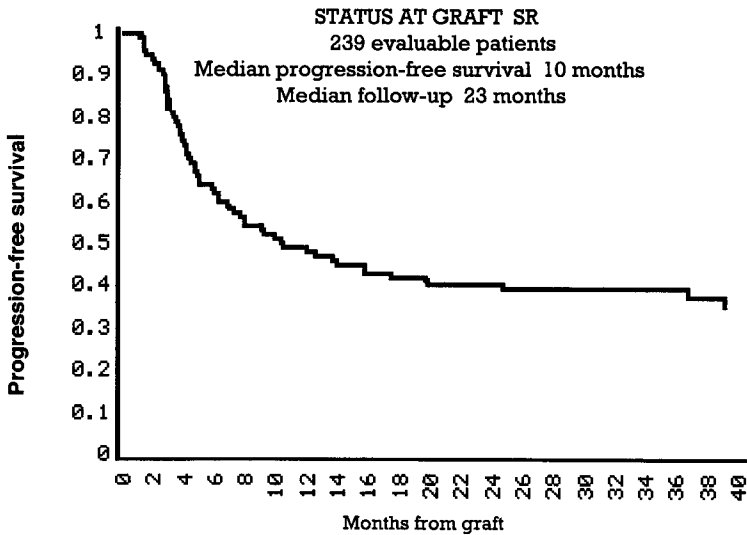
In 1994, the EBMT launched an international study, named IT-94, for patients with an incomplete response or those relapsing after a previous complete remission who are randomized to 4 courses of standard therapy (VeIP [vinblastine, ifosfamide, cisplatin] or

**EBMT 99 GERM CELL TUMORS**



**Figure 3.** Overall survival for patients with refractory disease. Source: European Group for Blood and Marrow Transplantation database.

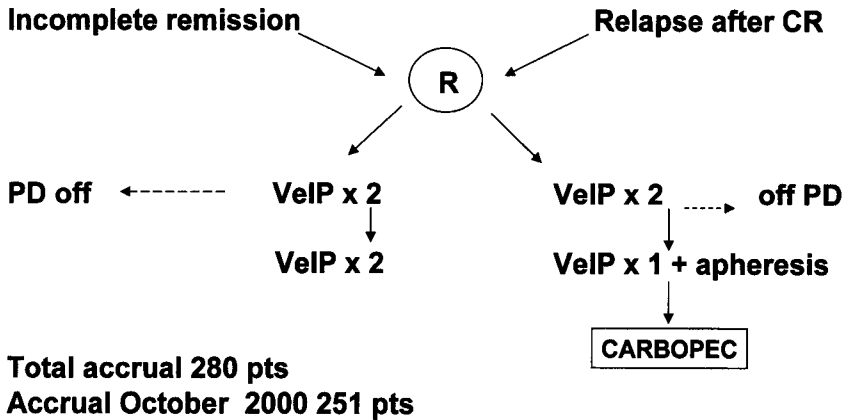
**EBMT 99 GERM CELL TUMORS**



**Figure 4.** Progression-free survival for 239 patients with sensitive relapse (second complete remission excluded). Source: European Group for Blood and Marrow Transplantation database.



## THE EBMT IT-94 STUDY (GERM CELL TUMORS)



**Figure 5.** The European Group for Blood and Marrow Transplantation IT-94 study. Carbopec, high-dose carboplatin, etoposide, and cyclophosphamide; CR, complete remission; PD, progressive disease; pt, patient; R, randomization; VeIP, vinblastine, ifosfamide, cisplatin.

PEI [cisplatin, etoposide, ifosfamide]) or 3 courses of standard therapy followed by high-dose carboplatin, etoposide, and cyclophosphamide (carbopec) (Figure 5). After a first interim analysis of 140 patients in 1998, it was decided to continue until 280 patients had accrued. By June 2000, 243 patients from 10 European countries have been randomized. This study (scheduled to be closed by the end of 2000) should give the definitive answer concerning the role of carbopec high-dose chemotherapy in patients relapsing or in incomplete remission after front-line therapy.

### REFERENCES

1. Bajorin DF, Mazumdar M, Meyers M, et al. Metastatic germ cell tumors: modeling for response to chemotherapy. *J Clin Oncol* 16:707-715, 1998.
2. Rosti G, Ferrante P: The EBMT Solid Tumors Registry 1999 Report, Faenza, 2000.
3. Bosl GJ, Motzer RJ: Testicular germ-cell cancer. *N Engl J Med* 337:242-253, 1997.
4. Beyer J, Kramar A, Mandanas R, et al. High-dose chemotherapy as salvage treatment in germ cell tumors: a multivariate analysis of prognostic variables. *J Clin Oncol* 14: 2638-2645, 1996.
5. Rodenhuis S, de Witt R, de Mulder PH, et al. A multicentric prospective phase II study on high-dose chemotherapy in germ cell cancer patients relapsing from complete remis-

- sion. *Ann Oncol* 10:1467–1473, 1999.
6. Rosti G, Albertazzi L, Salvioni R, et al. High-dose chemotherapy supported with autologous bone marrow transplantation. *Ann Oncol* 3:809–812, 1992.
  7. Motzer RJ, Mazumdar M, Bajorin DF, Bosl GJ, Lyn P, Vlamis V. High-dose carboplatin, etoposide and cyclophosphamide with autologous bone marrow transplantation in first line therapy for patients with poor-risk germ cell tumors. *J Clin Oncol* 15:2546–2552, 1997.
  8. Beyer J, Stenning S, Gerl A, Fossa S, Siegert W. High-dose (HDCT) versus conventional-dose (CDCT) first salvage treatment in patients (pts) with nonseminoma (NSGCT): a matched-pair analysis [abstract]. *Bone Marrow Transplant* 25 (Suppl 1), 2000. Abstract 183.

# High-Dose Chemotherapy for Ovarian Cancer: Experience of the Solid Tumor Registry of the European Group for Blood and Marrow Transplantation

*Jonathan A. Ledermann*

*CRC and UCL Cancer Trials Centre, Department of Oncology, Royal Free and  
University College Medical School, University College London, UK*

## ABSTRACT

High-dose chemotherapy is more likely to be successful in tumors that have a high response rate to chemotherapy. Ovarian cancer may be particularly suited to this treatment, because many patients enter a clinical remission but relapse because of the emergence of drug resistance. Over the last 18 years, a large number of patients with ovarian cancer were reported to the solid tumor registry of the European Group for Blood and Marrow Transplantation (EBMT). Data on 254 patients with advanced or recurrent disease from 39 centers treated between 1982 and 1996 have been reviewed. One hundred five patients underwent high-dose therapy in complete remission or after very good partial response with microscopic disease, 27 in second remission, and the remainder in the presence of bulky disease after chemotherapy. Most received melphalan, carboplatin, or a combination, supported by autologous bone marrow or peripheral blood stem cells.

Survival following transplantation of patients in remission was significantly better than in other groups (median, 33 months vs. 14 months;  $P=0.0001$ ). The durability of remission was longer after transplantation in first compared with second remission. With a median follow-up of 76 months from diagnosis, the median disease-free and overall survival rates in stage III disease transplanted in remission are 42 and 59 months, and for stage IV disease, 26 and 40 months, respectively.

High-dose chemotherapy is beneficial only when used to consolidate a remission or to help overcome the adverse effect of residual disease after initial surgery. These results compare favorably with those seen following standard-dose chemotherapy but need to be confirmed in a randomized trial. OVCAT (Ovarian Cancer Trial) is a randomized EBMT trial of sequential high-dose chemotherapy compared with standard chemotherapy following initial surgery for ovarian cancer.

## INTRODUCTION

Ovarian cancer is the fourth most common cause of cancer death in women. Early stages of the disease are often asymptomatic and, at the time of diagnosis, the majority of women have advanced disease. Control of the disease has improved over the last 20 years with the use of aggressive cytoreduction and platinum-based chemotherapy. The introduction of taxanes suggests that survival may be further increased.<sup>1</sup> However, the majority of patients still relapse and die of their disease; only 25%–30% of patients with advanced disease (International Federation of Gynaecological Oncologists [FIGO] stage III or IV) remain alive at 5 years.<sup>2,3</sup> Drug resistance remains the principal obstacle to successful therapy, and dose intensification of chemotherapy, which has been shown to be effective in some chemosensitive tumors, is one strategy that might overcome relative drug resistance. Ovarian cancer is very chemosensitive; typically more than 70% of patients will respond to chemotherapy, and a retrospective analysis has shown that tumor response and survival are related to drug dose intensity.<sup>4,5</sup> Prospective randomized studies have generally not supported this view, however; but the level of dose escalation has been small, usually about twice the standard dose of platinum.<sup>6</sup>

High-dose chemotherapy has been studied in ovarian cancer, but early reports were mainly confined to the treatment of small numbers of patients with disease that usually was resistant to standard chemotherapy. More recently, results have been reported from centers treating larger cohorts of patients.<sup>7–11</sup> The Solid Tumor Registry for the EBMT was set up in 1981, and the Solid Tumor Working Party, established in 1984, now has data on more than 14,000 patients treated with high-dose chemotherapy.

Between 1982 and 1996, 254 patients with ovarian cancer were reported to the Solid Tumor Registry. This article describes the outcome of this group and the current prospective EBMT randomized study that has been initiated as a result of the analysis of the registry data.

## PATIENTS AND METHODS

The patients with ovarian cancer diagnosed between September 1975 and December 1995 were given high-dose chemotherapy between October 1982 and January 1996. The data submitted to the registry from 39 centers were reviewed. The median age was 46 years (range, 14 to 63 years). More than 90% of patients had FIGO stage III or IV disease, and the distribution of histologic subtype was typical for advanced disease. Cytoreductive surgery was performed in 64.1% of patients; in 64 patients (25.2%), there was either no residual disease or residual disease was microscopic. Macroscopic disease was known to be present in 42.5% of patients. At least 10.6% had no surgery, and in 21.7%, there were no details of

the diagnostic procedure. Most patients received initial chemotherapy, and 75% of the group received platinum-based therapy. The overall survival (OS) and disease-free survival (DFS) rates were estimated using the Kaplan-Meier method. Differences between groups were assessed by the log-rank test.

### Patient Characteristics at the Time of Graft and High-Dose Therapy

The disease status before high-dose therapy is summarized in Table 1. There were 288 grafts (18 patients received either double or triple grafts). In the group transplanted in first complete remission (CR1) or very good partial remission (VGPR1), defined as microscopic residual disease at a second-look procedure, there were only 3 patients with early disease (stage I or II). The CR1 or VGPR1 group contained 29 of the 64 patients with microscopic or no residual disease after initial surgery. We do not know how many of the remaining 76 patients in CR1 or VGPR1 had little disease at the end of their operation, because surgical details were not recorded in 55 patients.

The group transplanted in second remission (CR2) contained 13 patients who relapsed after stage I or II disease. The remaining 116 patients (45.6%) were not in remission when they received high-dose chemotherapy. Some were in sensitive relapse, but the majority had resistant bulky relapse.

### Graft and High-Dose Therapy Regimens

There was a shift from autologous bone marrow transplantation (autoBMT) to peripheral blood stem cell transplantation (PBSCT) with time. AutoBMT was performed in 155 patients, 8 patients received autoBMT and PBSCT, and 120 received PBSCT (data were unavailable for 5 grafts). Two hundred forty-seven procedures (85.8%) used a regimen that included platinum-based drugs, chiefly

**Table 1.** Disease Status Before High-Dose Therapy\*

<i>Status</i>	<i>n</i>	<i>%</i>
First CR	88	35.0
VGPR1	17	6.7
First PR	67	26.4
Second CR	27	10.6
SD/RD/SR/RR/relapse	49	19.3
Unknown	6	2.0

\*CR, complete response; PR, partial response; RD, primary refractory; RR, resistant relapse; SD, stable disease (<50%); SR, sensitive relapse; VGPR, very good partial response.

carboplatin, melphalan, or both. Cyclophosphamide was a part of the 23 regimens with agents other than cisplatin or carboplatin and melphalan. Most patients in first complete or partial remission received the transplant within 12 months of diagnosis. The time to transplantation was much more variable, as expected in patients transplanted in second CR. Overall, 174 patients received high-dose chemotherapy within 12 months of diagnosis.

## OUTCOME

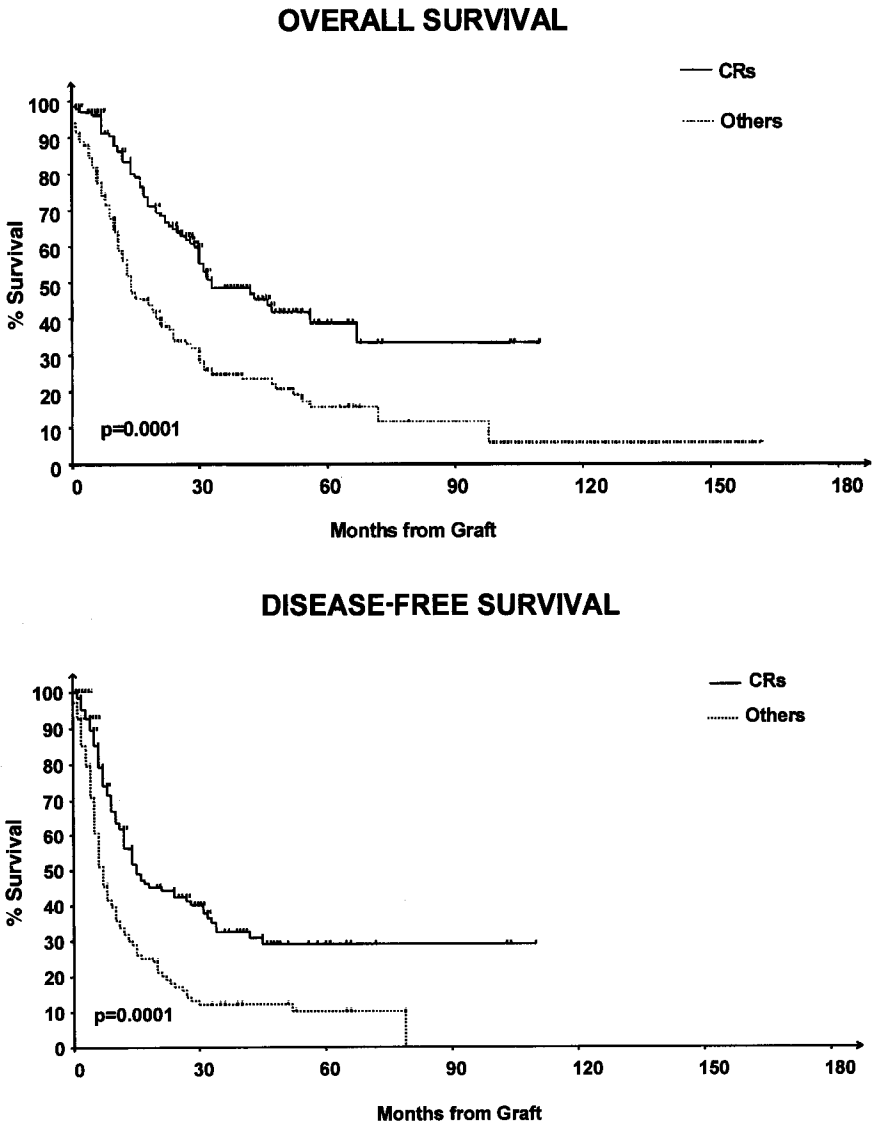
The data were frozen on October 1, 1998. The overall survival and duration of remission (DFS following transplantation) were significantly longer in patients given high-dose chemotherapy in remission (CR1, second CR, or VGPR1) than in those receiving high-dose chemotherapy in a partial remission or with stable or resistant disease. The median survival of 132 patients transplanted in remission was 33 months (from the time of the graft) compared with 14 months in those who were not in remission ( $P=.0001$ ). The median follow up is  $>5$  years, and no patient in the CR group has relapsed beyond 3.5 years (Figure 1). Patients who received high-dose therapy in first remission or VGPR1 had a more durable remission than those transplanted in second CR. The median disease-free survival was 18 vs. 9 months ( $P=.005$ ). Although the DFS was significantly lengthened, there was no significant difference in OS following the graft ( $P=.15$ ). The median follow-up was 76 months from diagnosis for the 76 stage III and 24 stage IV patients transplanted in first remission. The median DFS was 42 months for stage III and 26 months for stage IV patients, and the median OS was 59 months for stage III and 40 months for stage IV patients. These differences are not statistically significant.

## TOXICITY

One hundred sixty-nine patients relapsed or progressed after the last transplant (no information is available on 6 patients). One hundred fifty-seven patients died, and the cause of death was available for 124 patients. The cause of death was original disease alone in 97 patients and other causes including original disease in a further 8 patients. Procedure-related deaths within 90 days occurred in 18 patients (7.0%), principally infection, hematologic toxicity, and multiorgan failure. Original disease contributed to the cause of death in 3 patients who died within 90 days.

## DISCUSSION

The large number of patients reported to the solid tumor registry of the EBMT over the last decade reflects the growing interest in high-dose chemotherapy. Ovarian cancer is a disease with a high response rate to platinum-based chemo-



**Figure 1.** A, Overall survival. B, Disease-free survival for patients in first clinical remission (CR1), first very good partial remission, and CR2 ( $n = 132$ ) vs. others (partial remission and residual disease sensitive or resistant to chemotherapy) ( $n = 116$ ).

therapy.<sup>12,13</sup> A common theme from centers with experience in treating large numbers of patients with high-dose chemotherapy is that only the patients in remission or with small-volume drug-sensitive disease appear likely to benefit.<sup>10,11</sup>

A median survival of 14 months after high-dose chemotherapy in the EBMT series shows that many patients died soon after therapy. Less than 20% survived more than 5 years after the procedure; these are probably the few patients with drug-sensitive disease who were given high-dose therapy.

There is, however, a group of patients given high-dose therapy to consolidate remissions that fared significantly better. This group, comprising just over half the total patients in the EBMT series, had a 5-year survival after transplantation of just under 40%. Their median survival of 33 months following consolidation therapy suggests that high-dose treatment may favorably affect the natural history of advanced ovarian cancer. Furthermore, half the patients have been followed for more than 5 years, and late relapse is uncommon.

The best results are seen in patients transplanted in remission. Transplantation in first remission produces a more stable response than transplantation following a second remission. Interestingly, the overall survival of the 2 groups was not different, probably reflecting the presence of continuing drug sensitivity in a proportion of patients who attain a second remission. The median survival from diagnosis of patients in CR1 or VGPR1 was 54 months (4.5 years), and the disease-free survival was 32 months. These results are similar to the largest series published so far from Clermont-Ferrand, France. (It should be noted that some of the patients in the series by Legros et al.<sup>10</sup> are included in the EBMT registry.)

Patient selection is a common and valid criticism of the beneficial results in survival following high-dose therapy. In a case study from the Netherlands, prognostic factor analysis has identified small-volume disease after surgery as a favorable indicator of outcome in stage III or IV disease.<sup>3</sup> In that group, the median survival was 7.8 years, falling to 4.2 years in patients who had either no residual disease or microscopic disease after platinum-based chemotherapy. The 5-year survival of the 2 groups was 64% and 35%. Whereas attainment of CR or VGPR clearly favors good outcome, the majority of patients in the EBMT series did not have a surgically defined response. At least 17 patients had microscopic disease. Only 29 patients of 105 were known to have no macroscopic disease at the end of primary surgery. Even if all the 55 patients in the unknown disease category at the start of treatment were added to this group, there would still be at least 20% of patients who started treatment with macroscopic disease. In summary, the group in clinical remission is heterogeneous—some had a pathological complete remission, and others had microscopic or larger-volume disease, not clinically detectable.

The 5-year probability of survival for patients transplanted in clinical remission is 48% for patients with stage III disease and 35% for patients with stage IV ovarian cancer. Some of these patients had residual disease after surgery, and in general, such patients do not have a good long-term survival. It appears that high-dose consolidation therapy may have benefited patients with less favorable prognostic features to an even greater extent, such that the overall outcome of the

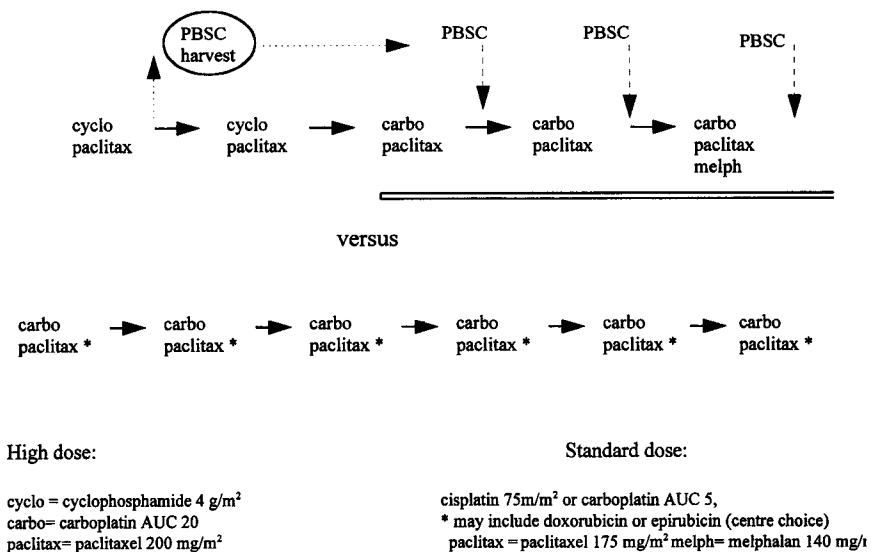


subset of patients in CR1 and VGPR is as good as those of patients with a surgically documented remission.

Published randomized studies of dose intensity in ovarian cancer have examined the effect of an approximately 2-fold increase in dose. That increase was insufficient to make an impact on outcome and has helped to fuel a widespread criticism of dose-intense therapy in solid tumors. Melphalan and carboplatin, 2 active drugs in ovarian cancer, may be escalated considerably and may be given sequentially.<sup>14-16</sup> High-dose chemotherapy supported by autoBMT, PBSCT, and granulocyte colony-stimulating factor results in significant toxicity. Over time, toxicity has fallen such that the overall procedure-related (90-day) mortality of 7% is now only about 3%.

There are 2 main conclusions to be drawn from the registry data. First, there can be no role for consolidation high-dose therapy in patients who are not in remission after chemotherapy or who have bulky disease after chemotherapy. Second, the results of treatment of patients in remission appear better than after current standard therapy. However, a note of caution should be sounded, as the registry data do not constitute either a cohort or a randomly assigned group. A prospective randomized study must be conducted to evaluate high-dose chemotherapy in the first-line treatment of ovarian cancer.

Three randomized trials of consolidation chemotherapy were started a few years ago. A French GINECO (Groupe des Investigateurs Nationaux pour l'Etude des



**Figure 2.** EBMT trial of sequential high-dose chemotherapy for ovarian cancer (OVCAT). AUC, area under the curve; PBSC, peripheral blood stem cell.

Cancers de l'Ovaire) study expects to close this year with 120 patients. A second study from Finland (FINOVA) continues to recruit slowly, and a third from FIGO closed early because it was difficult to recruit patients to a consolidation arm that contained either high-dose or more standard therapy. The EBMT has adopted a different approach using sequential high-dose chemotherapy. This approach has been chosen because multiple cycles of treatment may be given at a time when acquired drug resistance is least likely. Patients are randomized after surgery to receive either standard platinum-paclitaxel therapy or 2 cycles of cyclophosphamide and paclitaxel followed by 3 cycles of paclitaxel, with peripheral blood stem cell-supported high-dose carboplatin and high-dose melphalan added to the final cycle (Figure 2). High-dose sequential therapy has been shown to result in high response rates,<sup>17</sup> and a pilot study performed by Wandt et al.<sup>18</sup> showed the regimen to have acceptable toxicity. OVCAT and a similar study conducted by a German group will determine whether multicycle high-dose chemotherapy is a useful step forward in the management of advanced epithelial ovarian cancer.

### ACKNOWLEDGMENTS

I would particularly like to thank Ruth Herd, Murielle Buclon, and Patrizia Ferrante at the EBMT data centers in Lyon, London, and Ravenna for assisting in the preparation of the data. I would like to acknowledge the work of the present and past chairs of the solid tumor working party of the EBMT (Giovanni Rosti and Thierry Philip) and all the investigators who reported patients to the registry.

### REFERENCES

1. McGuire WP, Hoskins WJ, Brady MF, et al. Cyclophosphamide and cisplatin compared with paclitaxel and cisplatin in patients with stage III and stage IV ovarian cancer. *N Engl J Med* 334:1–6, 1996.
2. Advanced Ovarian Cancer Trialists Group. Chemotherapy in advanced ovarian cancer: an overview of randomised clinical trials. *BMJ* 303:884–893, 1991.
3. Neijt JP, ten Bokkel Huinink WW, van der Burg MEL, et al. Long-term survival in ovarian cancer: mature data from The Netherlands Joint Study Group for Ovarian Cancer. *Eur J Cancer* 27:1367–1372, 1991.
4. Levin L, Hryniuk WM. Dose intensity analysis of chemotherapy regimens in ovarian carcinoma. *J Clin Oncol* 5:756–767, 1987.
5. Levin L, Simon R, Hryniuk W. Importance of multiagent chemotherapy regimens in ovarian carcinoma: dose intensity analysis. *J Natl Cancer Inst* 85:1732–1742, 1993.
6. Thigpen J. Dose-intensity in ovarian carcinoma: hold, enough? *J Clin Oncol* 15:1291–1293, 1997.
7. Viens P, Maraninchi D, Legros M, et al. High dose melphalan and autologous marrow rescue in advanced epithelial ovarian carcinomas: a retrospective analysis of 35 patients

- treated in France. *Bone Marrow Transplant* 5:227–233, 1990.
8. Lotz JP, Machover D, Malassagne B, et al. Phase I-II study of two consecutive courses of high-dose epipodophyllotoxin, ifosfamide, and carboplatin with autologous bone marrow transplantation for treatment of adult patients with solid tumors. *J Clin Oncol* 9:1860–1870, 1991.
  9. Benedetti-Panici P, Greggi S, Scambia G, et al. High-dose chemotherapy with autologous peripheral stem cell support in advanced ovarian cancer. *Ann Med* 27:133–138, 1995.
  10. Legros M, Dauplat J, Fleury J, et al. High-dose chemotherapy with hematopoietic rescue in patients with stage III to IV ovarian cancer: long-term results. *J Clin Oncol* 15:1302–1308, 1997.
  11. Stiff PJ, Bayer R, Kerger C, et al. High-dose chemotherapy with autologous transplantation for persistent/relapsed ovarian cancer: a multivariate analysis of survival for 100 consecutively treated patients. *J Clin Oncol* 15:1309–1317, 1997.
  12. Omura G, Blessing JA, Ehrlich CE, et al. A randomized trial of cyclophosphamide and doxorubicin with or without cisplatin in advanced ovarian carcinoma: a Gynecologic Oncology Group Study. *Cancer* 57:1725–1730, 1986.
  13. Neijt JP, ten Bokkel Huinink WW, van der Burg ME, et al. Randomised trial comparing two combination chemotherapy regimens (Hexa-CAF vs CHAP-5) in advanced ovarian carcinoma. *Lancet* ii:594–600, 1984.
  14. Lazarus HM, Herzig RH, Graham-Pole J, et al. Intensive melphalan chemotherapy and cryopreserved autologous bone marrow transplantation for the treatment of refractory cancer. *J Clin Oncol* 1:359–367, 1983.
  15. Shea TC, Flaherty M, Elias A, et al. A phase I clinical and pharmacokinetic study of carboplatin and autologous bone marrow support [published erratum appears in *J Clin Oncol* 7:1177, 1989]. *J Clin Oncol* 7:651–661, 1989.
  16. Ayash LJ, Elias A, Wheeler C, et al. Double dose-intensive chemotherapy with autologous marrow and peripheral-blood progenitor-cell support for metastatic breast cancer: a feasibility study. *J Clin Oncol* 12:37–44, 1994.
  17. Fennelly D, Schneider J, Spriggs D, et al. Dose escalation of paclitaxel with high-dose cyclophosphamide, with analysis of progenitor-cell mobilization and hematologic support of advanced ovarian cancer patients receiving rapidly sequenced high-dose carboplatin/cyclophosphamide courses. *J Clin Oncol* 13:1160–1166, 1995.
  18. Wandt H, Birkmann J, Denzel T, et al. Sequential cycles of high-dose chemotherapy with dose escalation of carboplatin with or without paclitaxel supported by G-CSF mobilized peripheral blood progenitor cells: a phase I/II study in advanced ovarian cancer. *Bone Marrow Transplant* 23:763–770, 1999.

# Autologous Stem Cell Transplantation for High-Risk Neuroblastoma

**Judith G. Villablanca, Katherine K. Matthay, C. Patrick Reynolds,  
Robert Gerbing, Daniel Stram, Robert C. Seeger**

*Children's Hospital (J.G.V., C.P.R, R.C.S.), LA/USC School of Medicine,  
Los Angeles; UCSF School of Medicine (K.K.M.), San Francisco;  
Children's Cancer Group (R.G., D.S.), Arcadia, California*

## ABSTRACT

Despite initial responses, long-term survival for children with high-risk neuroblastoma using conventional chemoradiotherapy is only 15%. The recently completed phase 3 national randomized trial (Children's Cancer Group [CCG] 3891) demonstrated that myeloablative consolidation using carboplatin, etoposide, melphalan, and total body irradiation (TBI) with purged autologous bone marrow infusion (autoBMT) significantly improved 3-year event-free survival (EFS) compared with nonmyeloablative chemotherapy consolidation ( $34\% \pm 4\%$  vs.  $22\% \pm 4\%$ ;  $P=.034$ ). Therapy with 13-*cis* retinoic acid (13-cRA) postconsolidation also significantly improved EFS ( $46\% \pm 6\%$  vs.  $29\% \pm 5\%$ ;  $P=.027$ ). The best outcome was achieved with the combination of myeloablative chemotherapy and autoBMT plus 13-cRA, with an estimated EFS of  $38\% \pm 6\%$  from the time of diagnosis. This approach is now the standard for therapy of high-risk neuroblastoma. However, relapses indicate the need for more effective primary site control, as well as agents active against resistant minimal residual disease (MRD).

Our subsequent CEM-LI (carboplatin, etoposide, melphalan, and local irradiation) pilot study eliminated TBI from the transplant regimen. This allowed significant dose escalation of carboplatin and etoposide. Stem cell infusion was either purged autologous marrow or purged peripheral blood stem cells (PBSCs). Local radiation was given to all primary sites, as well as residual metastatic sites. Posttransplant therapy was allowed and may have included 13-cRA and/or anti-G<sub>D2</sub> antibody and granulocyte-macrophage colony-stimulating factor (GM-CSF). One hundred six children were transplanted in first ( $n = 77$ ) or second ( $n = 29$ ) remission. The 3-year EFS for all patients transplanted in first remission was  $64\% \pm 9\%$ ; that for stage 4 patients >1 year of age in first remission was  $61\% \pm 12\%$ . Relapses occurred at primary and distant ( $n = 3$ ), primary ( $n = 2$ ), and distant ( $n = 18$ ) sites; only 3 of 20 reviewed were within the irradiation field. This strategy appears to have decreased primary site relapse.

The next phase 3 Children's Oncology Group (COG) study (A3973) will use intensive induction chemotherapy, followed by consolidation with CEM-LI and posttransplant therapy with 13-cRA. Patients will be randomized to receive either purged or unpurged PBSCs to determine the effect of purging on EFS and MRD. A second randomization adding anti-G<sub>D2</sub> antibody (ch14.18) and GM-CSF and interleukin (IL)-2 (COG-P9842) after autoSCT vs. 13-cRA alone will determine if EFS can be improved by another therapy directed against MRD.

Future therapies in development include chemotherapy resistance modifiers (such as glutathione depletion with buthionine sulfoximine [BSO]), targeted radiotherapy with <sup>131</sup>I-metaiodobenzylguanidine (<sup>131</sup>I-MIBG), and novel retinoids (fenretinide). Integration of these strategies should further improve the outcome of children with high-risk neuroblastoma.

## INTRODUCTION

Neuroblastoma, the second most common solid tumor in children, can be stratified into risk groups at diagnosis using age, tumor stage, histopathology, and the presence of amplification of the *MYCN* oncogene.<sup>1-3</sup> Conventional-dose chemoradiotherapy can achieve a complete response in the majority of high-risk patients; however, the long-term survival is only 15%.<sup>1</sup> Pilot studies suggested that high-dose myeloablative chemotherapy may improve the outcome.<sup>4-12</sup> This provided the rationale for a national randomized prospective trial, CCG 3891,<sup>13</sup> to determine if myeloablative chemotherapy and transplantation with purged autologous bone marrow could achieve a better EFS than nonmyeloablative chemotherapy. The observation of a high incidence of relapse in patients who had no measurable tumor posttransplant<sup>8</sup> led to another pilot study to determine the toxicity of 13-cRA in the posttransplant setting.<sup>14</sup> It had been shown in the laboratory that 13-cRA could induce differentiation, decrease proliferation, and downregulate *MYCN* expression in neuroblastoma tumor cell lines, including some established from refractory tumors after autoBMT.<sup>15-18</sup> The effect of 13-cRA on EFS when given on a randomized basis posttransplant was also examined in the CCG 3891 trial. This article summarizes the results of the CCG 3891 study, as well as preliminary results of a successor pilot transplant study (CEM-LI) that eliminated total body irradiation from the transplant regimen, escalated doses of the chemotherapy, and intensified the local radiation therapy. Trials currently in progress that are piloting novel transplant regimens and/or posttransplant therapies for resistant minimal residual disease in high-risk neuroblastoma are also summarized.

## MATERIALS AND METHODS

For the clinical studies described, written informed consent was obtained from the parent and/or guardian, and studies were approved by the participating

institutions' investigational review boards. Eligible patients were 1–18 years of age for CCG 3891 and 9 months to 25 years of age for the CEM-LI pilot. High-risk neuroblastoma was defined as all patients with Evans' syndrome (ES) stage IV<sup>19</sup> >1 year of age at diagnosis; ES stage IV <1 year of age at diagnosis with *MYCN* amplification; ES stage III with *MYCN* amplification, unfavorable histopathology, and/or serum ferritin >143 ng/mL; ES stage II with *MYCN* amplification; or ES stage I/II with development of bone metastases after surgical resection alone. Patients transplanted on both CCG 3891 and the CEM-LI pilot received autologous stem cells purged at the Neuroblastoma Purging Center of the CCG. Bone marrow was purged using the previously published method,<sup>7,20,21</sup> with immunomagnetic beads. PBSCs were purged with a modification of this method, using an additional initial step with carbonyl iron<sup>22</sup> to remove monocytes and neutrophils. All infused stem cell products had no evidence of neuroblastoma tumor cells by immunocytology,<sup>23</sup> as performed by the Neuroblastoma Reference Lab of the CCG, with a sensitivity of 1 tumor cell per 10<sup>5</sup> nucleated bone marrow cells.

### CCG 3891

Methods for this study have been published previously.<sup>13</sup> The patient population consisted of children ages 1–18 years with newly diagnosed high-risk neuroblastoma entered on a prospective randomized national study from 1991 to 1996, including 434 with ES stage IV >1 year of age, 72 with ES stage III with high-risk features, 1 with ES stage II with *MYCN* amplification, 13 with ES stage I or II who developed bone metastases after surgical resection only, and 19 <1 year of age with ES stage IV and *MYCN* amplification. There were no significant differences in the prognostic features of the randomized groups for either the first randomization (at 8 weeks from diagnosis) to transplant vs. continuation chemotherapy or the second randomization (at completion of the assigned chemoradiotherapy arm) to 13-cRA vs. no further therapy. Doses for the transplantation regimen from CCG 3891 are summarized in Table 1. Carboplatin and etoposide were given on days –7 through –4 as a continuous intravenous (IV) infusion. Melphalan was given as 140 mg/m<sup>2</sup> on day –7 and 70 mg/m<sup>2</sup> on day –6. The TBI was given as 333 cGy/day on days –3 through –1. The 13-cRA was given every 28 days as 160 mg/m<sup>2</sup>/day for 14 days, followed by a 14-day rest, beginning at day 84 after completion of chemoradiotherapy. Local radiotherapy (1000 cGy over 5 days) was given at the end of the induction chemotherapy to persistent metastatic sites and to the primary site only if there was residual tumor. Further details of the CCG 3891 study and the statistical analyses used have been published previously.<sup>13</sup>

**Table 1.** Comparison of Total Doses of Chemotherapy Drugs and Radiation for CCG 3891 and CEM-LI Regimens\*

	CCG 3891	CEM-LI (GFR >100)	CEM-LI (GFR <100)
Carboplatin, mg/m <sup>2</sup>	1000	1700	AUC 16.4
Etoposide, mg/m <sup>2</sup>	800	1350	800
Melphalan, mg/m <sup>2</sup>	210	210	180
Local radiation, cGy	1000†	2100‡	2100‡
Total body irradiation, cGy	1000	None	None

\*AUC, area under the curve; GFR, glomerular filtration rate in cc/min per 1.73 m<sup>2</sup>. †To residual measurable tumor sites pretransplant. ‡To all primary sites and any residual metastatic sites.

### CEM-LI Pilot Study

Analyses reported here include patient accrual from 1991 to 1999. This study is still open and pending final analysis. Eligible patients included those with high-risk neuroblastoma who had been treated with any accepted induction therapy (including CCG 3891,<sup>13</sup> N6,<sup>24</sup> or other) in first remission and patients with stage III/IV who were in at least a partial remission after any reinduction therapy for relapse. One hundred six children were transplanted in first ( $n = 77$ ) or second ( $n = 29$ ) response. The chemotherapy regimen consisted of continuous-infusion carboplatin (escalated from 250–425 mg/m<sup>2</sup> per day), etoposide (escalated from 200–375 mg/m<sup>2</sup> per day) given IV days –7 through –3, and melphalan (fixed dose of 70 mg/m<sup>2</sup> per day) by bolus IV infusion days –7 through –4. Purged autologous bone marrow or peripheral blood stem cells were infused on day 0, followed by either GM-CSF 250  $\mu$ g/m<sup>2</sup> per day or G-CSF 10  $\mu$ g/kg per day until neutrophil engraftment occurred. The carboplatin dosage was calculated based on the pretransplant glomerular filtration rate (GFR) using the pediatric Calvert formula<sup>25</sup> for those patients with a GFR <100 cc/min per 1.73 m<sup>2</sup>, and this group of patients were dose-escalated separately from those patients with a GFR >100 cc/min per 1.73 m<sup>2</sup>. Local irradiation was given as two 150-cGy fractions per day, at least 4 hours apart, for a total dose of 1500–2100 cGy to the primary site regardless of extent of residual tumor and to any residual metastatic sites before transplant. Posttransplant therapy was allowed at the discretion of the treating physician, and included cRA, anti-G<sub>D2</sub> antibody plus GM-CSF, fenretinide, and/or gene therapy. Life-table estimates were calculated according to the Kaplan-Meier procedure.<sup>26</sup> The standard errors of the life-table estimates of event-free survival were calculated according to the method described by Peto et al.<sup>27</sup> Events considered were disease progression, death from any cause, and/or a second neoplasm, whichever occurred first.

## RESULTS

### CCG 3891

Myeloablative chemoradiotherapy and purged ABMT significantly improved the 3-year EFS from the time of the first randomization (8 weeks from diagnosis) compared with nonmyeloablative chemotherapy consolidation ( $34\% \pm 4\%$  vs.  $22\% \pm 4\%$ ;  $P=.034$ ).<sup>13</sup> Those patients randomized after completion of either arm of chemoradiotherapy to receive 13-cRA also had a significantly improved EFS at 3 years from the time of randomization ( $46\% \pm 6\%$  vs.  $29\% \pm 5\%$ ;  $P=.027$ ). The estimated EFS 3 years from the second randomization was  $55\% \pm 10\%$  for those patients assigned to transplantation followed by 13-cRA. The estimated 3.7-year EFS from the time of diagnosis was  $38\% \pm 6\%$  for patients receiving transplantation and 13-cRA, compared with only  $17\% \pm 4\%$  in the group treated with conventional-dose chemotherapy alone. For patients undergoing the first randomization treatment, there were 7% (9 of 129) treatment-related deaths vs. 1% (1 of 150) in those randomized to continuation chemotherapy ( $P=.013$ ).

### CEM-LI Regimen

The maximal tolerated doses of this regimen determined for patients with a GFR  $>100$  cc/min per  $1.73$  m<sup>2</sup> were carboplatin  $1700$  mg/m<sup>2</sup> and etoposide  $1350$  mg/m<sup>2</sup> given with melphalan  $210$  mg/m<sup>2</sup>. There were no toxic deaths in 58 patients transplanted in first remission with a GFR  $>100$  cc/min per  $1.73$  m<sup>2</sup>. For patients with a GFR  $<100$  cc/min per  $1.73$  m<sup>2</sup>, the maximal tolerated dosage was determined initially as a carboplatin area under the curve (AUC) of 16.4 with etoposide  $1000$  mg/m<sup>2</sup>, based on 6 patients treated at these doses. After further accrual, the etoposide dose was decreased to  $800$  mg/m<sup>2</sup> and the melphalan dose was decreased to  $180$  mg/m<sup>2</sup>, based on observation of additional toxicity. Accrual of patients to evaluate this dose-reduction level is continuing. Among 18 first-remission patients with a low GFR, there were 2 toxic deaths (11%). Overall, there were 2 of 76 (3%) toxic deaths in first-remission patients.

The EFS at 3 years from time of transplantation was  $64\% \pm 9\%$  for all patients transplanted in first remission. The 3-year EFS was  $61\% \pm 12\%$  for stage 4 patients  $>1$  year of age ( $n = 56$ ) in first response, of whom 70% received 13-cRA, 20% anti-G<sub>D2</sub> antibody, and 4% fenretinide posttransplantation. Relapses in the 58 patients transplanted in first response occurred at primary and distant ( $n = 3$ ), primary ( $n = 2$ ), and distant ( $n = 18$ ) sites. Three of the 20 relapse sites reviewed were within the irradiation field.



## DISCUSSION

The results of the randomized prospective CCG 3891 trial<sup>13</sup> have established myeloablative chemoradiotherapy with autologous transplantation followed by 6 months of 13-cRA as the standard of therapy for high-risk neuroblastoma. However, with an estimated survival from diagnosis of only 38% for patients treated with this standard, novel approaches are clearly needed to further improve outcome. The primary site is a common site of relapse posttransplantation,<sup>8</sup> indicating that local control needs to be addressed. In addition, CCG 3891 used total body irradiation, which is associated with increased acute toxicity in the early posttransplant period, as well as late effects including abnormalities in growth, thyroid dysfunction, abnormal dental development, and cataracts.<sup>28–32</sup>

We hypothesized that eliminating TBI would allow dose escalation of the chemotherapy used in the CCG 3891 transplant regimen and more intensive local radiation to the primary site, which would improve the EFS. As shown in Table 1, the doses of carboplatin and etoposide were successfully escalated in patients with a GFR >100 cc/min per 1.73 m<sup>2</sup>; however, this was not possible in the low GFR cohort due to toxicity. Current neuroblastoma regimens all contain nephrotoxic agents and, since nephrectomy is not uncommon with primary tumor resection, tailoring dose escalations based on renal function is an important issue to give most effective yet tolerable doses to all patients. The CEM-LI regimen had 3% (2 of 76) toxic deaths in first-remission patients vs. 7% (9 of 129) of patients transplanted with the CCG 3891 regimen. There were no toxic deaths on the CEM-LI regimen among patients with a normal GFR. Primary site relapses were observed in only 5 of 23 patients (22%) with the CEM-LI regimen. This suggests an improvement over previous studies in which radiation was not given consistently to the primary site, and local relapse occurred in ~50% of patients.<sup>8</sup> This observation needs to be confirmed in a larger number of patients. Distant relapses remain a significant issue, indicating the need for more effective therapy for minimal residual tumor following transplantation. The outcome with CEM-LI compares favorably with the CCG 3891 TBI regimen; however, there are differences in the prognostic features of the 2 patient populations that affect retrospective comparisons. These include induction therapy before transplant, response status before transplant, time from diagnosis to transplantation, and posttransplant therapy. We conclude from the CEM-LI pilot results that this regimen is well tolerated, the elimination of TBI does not adversely affect outcome, and more consistent intensive local radiation may decrease relapse at the primary site.

The next cooperative group study, A3973, will open this year in the COG. This study will use a more aggressive induction than CCG 3891 based on the N6 regimen,<sup>24</sup> which has reported the highest response rates to date. All patients will then be transplanted with the CEM-LI regimen, followed by 6 months of 13-cRA.

This study will provide a larger patient population to establish the EFS of the CEM-LI regimen and the incidence of primary site relapse. The A3973 study will use peripheral blood stem cells instead of bone marrow, based on data showing more rapid engraftment with PBSCs<sup>33–36</sup> and preliminary reports of a lower content of neuroblastoma tumor cells than in marrow.<sup>37–39</sup> Patients will be randomized at diagnosis to receive either purged or unpurged PBSCs, with the study end point to determine differences in EFS and overall survival between these 2 groups in patients with stage IV tumors who are >1 year old at diagnosis. The pilot of purged PBSC is near completion in the final cohort of patients on the CEM-LI study. Preliminary data in children with neuroblastoma who have no detectable tumor by immunocytology have shown the feasibility of collecting sufficient numbers of PBSCs after 2–3 cycles of induction chemotherapy and normal engraftment of the purged PBSCs.

The issue of purging stem cells for transplantation has never been examined in a randomized study. Previous studies for neuroblastoma have used either purged or unpurged stem cells. Some data suggest an advantage for purging, but no definitive conclusion can be made.<sup>4–7,10,12,13,39–45</sup> Gene marking studies in neuroblastoma<sup>46</sup> have demonstrated that tumor cells infused in marrow grafts can be found at sites of relapse. The minimum number of neuroblastoma tumor cells required to initiate tumor regrowth is not known and is likely to vary with the biologic characteristics of the individual tumor. The A3973 study will determine in a prospective randomized manner whether purging of PBSCs is associated with a significant difference in event-free survival in high-risk neuroblastoma.

The clinical standard for using stem cell products is the absence of neuroblastoma tumor cells detectable by immunocytologic assay, with a sensitivity of 1 tumor cell in  $10^5$  mononuclear cells.<sup>23</sup> Recently, more sensitive assays using reverse transcription–polymerase chain reaction (RT-PCR) methodology with markers of tyrosine hydroxylase and protein gene product (PGP) 9.5<sup>47</sup> can detect as few as 1 tumor cell in  $10^6$  mononuclear cells. Approximately 25% of purged bone marrow samples from the CCG 3891 study that were negative for tumor by immunocytology had detectable tumor by RT-PCR analysis (R.C.S., personal communication). The prognostic significance of these RT-PCR findings is not known, and will require a larger sample of patients. The A3973 study will perform RT-PCR analysis on all stem cell products to determine if there are differences in purged vs. unpurged PBSCs and whether tumor detected by RT-PCR has prognostic significance. Minimal residual tumor will also be assessed by RT-PCR and MIBG scans at various points during and after completion of therapy to determine if these assessments can predict outcome.

Other posttransplant therapies for neuroblastoma may further improve EFS when used in combination with 13-cRA. The ganglioside  $G_{D2}$  is expressed on the surface of almost all neuroblastoma tumor cells and is involved in the attachment of tumor

cells to the extracellular matrix. Antibodies against G<sub>D2</sub> have antitumor activity that can be augmented by GM-CSF and/or IL-2, which activate monocytes and lymphocyte-activated killer cells and enhance their ability to kill neuroblastoma tumor cells in combination with antibody.<sup>48-52</sup> Both murine and chimeric antibodies to G<sub>D2</sub> have demonstrated clinical responses in patients with recurrent neuroblastoma, especially in marrow metastases.<sup>49,53-58</sup> The CCG 0935A phase 1 study, which is a pilot of the chimeric anti-G<sub>D2</sub> antibody ch14.18 given with GM-CSF alternated with IL-2 and concurrent with 13-cRA, will be completed this year. The successor P9842 phase 3 cooperative group study will randomize patients from the A3973 COG study described above to 13-cRA alone vs. 13-cRA plus the CCG 0935A regimen, following transplantation with CEM-LI. The study end point will be differences in EFS and survival between the 2 groups. Differences in minimal residual tumor in patients treated on either study arm, as measured by RT-PCR of blood/marrow and MIBG scans, will also be examined as a secondary aim.

Another synthetic retinoid, *N*-(4-hydroxyphenyl)retinamide or fenretinide,<sup>59,60</sup> has potential as a future posttransplant therapy for minimal residual tumor. Fenretinide has demonstrated activity against neuroblastoma cell lines,<sup>61-64</sup> including those resistant to 13-cRA. Unlike 13-cRA, fenretinide induces apoptosis rather than differentiation.<sup>63</sup> Its mechanisms of action include an increase in ceramide levels,<sup>64</sup> increase in oxidative radicals,<sup>65</sup> and antiangiogenesis.<sup>66</sup> Its major toxicity is nyctalopia, and no significant hematopoietic toxicity has been reported<sup>60,67-69</sup>; therefore, it should be well tolerated after intensive chemoradiotherapy. A pediatric phase 1 study of oral fenretinide on an intermittent high-dose schedule (given tid for 7 days, followed by a 2-week rest) is currently in progress in the CCG (study 09709). Toxicity to date has been minimal at doses up to 1395 mg/m<sup>2</sup> per day, with preliminary analysis demonstrating that plasma levels can be achieved in patients which are comparable to those required in vitro for activity against neuroblastoma tumor cell lines (J.G.V., personal communication). Response data are blinded until completion of the study. A phase 2 study of fenretinide in neuroblastoma is planned in COG, pending determination of the maximal tolerated dosage. A future phase 3 study of fenretinide in the posttransplant setting is possible, pending results of these preliminary studies.

Agents that can reverse resistance to chemotherapy in neuroblastoma relapsing after myeloablative therapy should provide another avenue to improve outcome. BSO is a selective inhibitor of  $\gamma$ -glutamylcystein synthetase, the rate-limiting enzyme in glutathione synthesis.<sup>70</sup> BSO causes depletion of intracellular glutathione levels, which can enhance alkylator activity.<sup>70-72</sup> BSO exhibits cytotoxic activity as a single agent in in vitro neuroblastoma. The combination of BSO and the alkylator melphalan is synergistic in vitro against neuroblastoma cell lines, including some derived from patients transplanted with high-dose melphalan (210 mg/m<sup>2</sup>) regimens.<sup>73,74</sup> This synergy is most striking at levels of melphalan that

can be achieved in patients with myeloablative doses. A phase 1 study of BSO and melphalan<sup>75</sup> given at 15 mg/m<sup>2</sup> has demonstrated 27% responses in 20 evaluable patients with recurrent neuroblastoma, including 7 partial responses, 1 minor response, and 9 stable disease. The major toxicity was hematopoietic. A successor phase 1 study of BSO with escalating doses of melphalan (40–170 mg/m<sup>2</sup>) given with autologous stem cell support is planned to open this year in the New Approaches to Neuroblastoma Therapy (NANT) Consortium. Pending the toxicity and response data from the NANT study, the BSO/melphalan regimen may be incorporated into frontline studies.

### Metaiodobenzylguanidine

MIBG is a guanethidine derivative that structurally resembles norepinephrine and is concentrated in adrenergic tissue.<sup>76</sup> MIBG can be labeled with radioactive isotopes of iodine and used for diagnostic imaging (<sup>123</sup>I) or for both imaging and therapeutic treatment (<sup>131</sup>I) of neuroblastoma, which is a tumor of neuroectodermal origin.<sup>77–80</sup> Multiple studies using <sup>131</sup>I-MIBG in children with neuroblastoma have reported response rates from 10% to 50%, and none have observed nonhematologic dose-limiting toxicity.<sup>77,79,81–84</sup> A recently completed phase 1 study of <sup>131</sup>I-MIBG for recurrent neuroblastoma at the University of California–San Francisco<sup>85</sup> defined the maximal dose of <sup>131</sup>I-MIBG for hematopoietic toxicity as 12 mCi/kg, with no significant nonhematologic toxicity at doses up to 18 mCi/kg. The response rate among the 30 patients treated was 37%, including 1 complete, 10 partial, 3 minor, and 10 stable disease. Based on the response data and the hematopoietic dose-limiting toxicity that can be abrogated by stem cell support, a phase 1 study will open this year in the NANT Consortium using <sup>131</sup>I-MIBG in combination with the CEM-LI regimen and autologous stem cell support. Eligible patients will include those with poorly responding neuroblastoma after induction chemotherapy and those who develop progressive disease. <sup>131</sup>I-MIBG administration will be followed 2 weeks later by CEM-LI, with dose escalation of both <sup>131</sup>I-MIBG and CEM beginning at levels below the maximally defined doses. This study may provide a more effective myeloablative regimen that uses an agent specifically targeted to neuroblastoma.

### CONCLUSION

Significant progress has been made in the last decade in the therapy of high-risk neuroblastoma, with improvement in survival from 15% to 40% through the implementation of more intensive induction regimens, myeloablative consolidation with autologous transplantation, posttransplant therapy directed against minimal residual disease, and improvements in supportive care. Future studies are needed to

design more effective induction and myeloablative regimens with agents that can reverse chemoradiotherapy resistance and/or have novel mechanisms of action that are non-cross-resistant with chemoradiotherapy, for maximal reduction of tumor burden. Novel therapies directed against minimal residual disease will also be critical. The role of stem cell purging also needs to be defined. Finally, the long-term effects of these aggressive therapies must be monitored carefully to provide quality of life for the expected increased number of survivors.

### ACKNOWLEDGMENTS

The authors would like to thank Beth Hasenauer, RN, Amanda Benavides, CRA, Jamie Finn, Yolanda Stubbs, and Dee Goldsmith, RN, for their work on managing study entry and data. We also thank the principal investigators who participated in the CEM-LI study: Norma Ramsay, MD, University of Minnesota; Richard Harris, MD, Children's Hospital and Medical Center, Cincinnati; Ray Hutchinson, MD, University of Michigan; Joseph Rosenthal, MD, City of Hope Medical Center; Paul Gaynon, MD, University of Wisconsin; Garrett Brodeur, MD, Children's Hospital of Philadelphia; and Bruce Gordon, MD, University of Nebraska.

This work was supported by grants from the Division of Cancer Treatment, National Cancer Institute (CA13539 [to the Children's Cancer Group]; and CA60104 [to R.C.S.]; from the Neil Bogart Memorial Laboratories of the T.J. Martell Foundation for Leukemia, Cancer, and AIDS Research (to C.P.R., J.G.V., and R.C.S.); and from the American Institute for Cancer Research (to C.P.R.)

### REFERENCES

1. Matthay KK. Neuroblastoma: biology and therapy. *Oncology (Huntingt)* 11:1857-1866; discussion 1869-1872 and 1875, 1997.
2. Seeger RC, Brodeur GM, Sather H, et al. Association of multiple copies of the N-myc oncogene with rapid progression of neuroblastomas. *N Engl J Med* 313:1111-1116, 1985.
3. Shimada H, Ambros IM, Dehner LP, et al. The International Neuroblastoma Pathology Classification (the Shimada system). *Cancer* 86:364-372, 1999.
4. Dini G, Lanino E, Garaventa A, et al. Myeloablative therapy and unpurged autologous bone marrow transplantation for poor-prognosis neuroblastoma: report of 34 cases. *J Clin Oncol* 9:962-969, 1991.
5. Philip T, Zucker JM, Bernard JL, et al. Improved survival at 2 and 5 years in the LMCE1 unselected group of 72 children with stage IV neuroblastoma older than 1 year of age at diagnosis: is cure possible in a small subgroup? *J Clin Oncol* 9:1037-1044, 1991.
6. Kushner BH, O'Reilly RJ, Mandell LR, Gulati SC, LaQuaglia M, Cheung NK. Myeloablative combination chemotherapy without total body irradiation for neuroblastoma. *J Clin Oncol* 9:274-279, 1991.
7. Seeger RC, Villablanca JG, Matthay KK, et al. Intensive chemoradiotherapy and autol-

- ogous bone marrow transplantation for poor prognosis neuroblastoma. *Prog Clin Biol Res* 366:527–533, 1991.
8. Matthay KK, Atkinson JB, Stram DO, Selch M, Reynolds CP, Seeger RC. Patterns of relapse after autologous purged bone marrow transplantation for neuroblastoma: a Childrens Cancer Group pilot study. *J Clin Oncol* 11:2226–2233, 1993.
  9. Ohnuma N, Takahashi H, Kaneko M, et al. Treatment combined with bone marrow transplantation for advanced neuroblastoma: an analysis of patients who were pretreated intensively with the protocol of the Study Group of Japan. *Med Pediatr Oncol* 24:181–187, 1995.
  10. Garaventa A, Rondelli R, Lanino E, et al. Myeloablative therapy and bone marrow rescue in advanced neuroblastoma: report from the Italian Bone Marrow Transplant Registry. Italian Association of Pediatric Hematology-Oncology, BMT Group. *Bone Marrow Transplant* 18:125–130, 1996.
  11. Stram DO, Matthay KK, O’Leary M, et al. Consolidation chemoradiotherapy and autologous bone marrow transplantation versus continued chemotherapy for metastatic neuroblastoma: a report of two concurrent Children’s Cancer Group studies. *J Clin Oncol* 14:2417–2426, 1996.
  12. Ladenstein R, Philip T, Lasset C, et al. Multivariate analysis of risk factors in stage 4 neuroblastoma patients over the age of one year treated with megatherapy and stem-cell transplantation: a report from the European Bone Marrow Transplantation Solid Tumor Registry. *J Clin Oncol* 16:953–965, 1998.
  13. Matthay KK, Villablanca JG, Seeger RC, et al. Treatment of high-risk neuroblastoma with intensive chemotherapy, radiotherapy, autologous bone marrow transplantation, and 13-*cis*-retinoic acid. Children’s Cancer Group. *N Engl J Med* 341:1165–1173, 1999.
  14. Villablanca JG, Khan AA, Avramis VI, et al. Phase I trial of 13-*cis*-retinoic acid in children with neuroblastoma following bone marrow transplantation. *J Clin Oncol* 13:894–901, 1995.
  15. Thiele CJ, Reynolds CP, Israel MA. Decreased expression of N-*myc* precedes retinoic acid-induced morphological differentiation of human neuroblastoma. *Nature* 313:404–406, 1985.
  16. Reynolds CP, Schindler PF, Jones DM, Gentile JL, Proffitt RT, Einhorn PA. Comparison of 13-*cis*-retinoic acid to *trans*-retinoic acid using human neuroblastoma cell lines. *Prog Clin Biol Res* 385:237–244, 1994.
  17. Reynolds CP, Kane DJ, Einhorn PA, et al. Response of neuroblastoma to retinoic acid in vitro and in vivo. *Prog Clin Biol Res* 366:203–211, 1991.
  18. Sidell N. Retinoic acid-induced growth inhibition and morphologic differentiation of human neuroblastoma cells in vitro. *J Natl Cancer Inst* 68:589–596, 1982.
  19. Evans AE, D’Angio GJ, Randolph J. A proposed staging for children with neuroblastoma. Children’s cancer study group A. *Cancer* 27:374–378, 1971.
  20. Reynolds CP, Seeger RC, Vo DD, Black AT, Wells J, Ugelstad J. Model system for removing neuroblastoma cells from bone marrow using monoclonal antibodies and magnetic immunobeads. *Cancer Res* 46:5882–5886, 1986.
  21. Matthay KK, Seeger RC, Reynolds CP, et al. Allogeneic versus autologous purged bone marrow transplantation for neuroblastoma: a report from the Childrens Cancer Group.

- J Clin Oncol* 12:2382–2389, 1994.
22. Holtrop S, Rijke-Schilder GP, Tamboer WP, Koene RA, Tax WJ. Removal of monocytes from cell suspensions with anti-CD14 antibody and carbonyl-iron, using Fc gamma R-dependent accessory function as a sensitive measure of monocyte presence. *J Immunol Methods* 156:217–222, 1992.
  23. Moss TJ, Reynolds CP, Sather HN, Romansky SG, Hammond GD, Seeger RC. Prognostic value of immunocytologic detection of bone marrow metastases in neuroblastoma. *N Engl J Med* 324:219–226, 1991.
  24. Kushner BH, LaQuaglia MP, Bonilla MA, et al. Highly effective induction therapy for stage 4 neuroblastoma in children over 1 year of age. *J Clin Oncol* 12:2607–2613, 1994.
  25. Newell DR, Pearson AD, Balmanno K, et al. Carboplatin pharmacokinetics in children: the development of a pediatric dosing formula. The United Kingdom Children's Cancer Study Group. *J Clin Oncol* 11:2314–2323, 1993.
  26. Kaplan EL, Meier P. Nonparametric estimation from incomplete observations. *J Am Stat Assoc* 53:457–481, 1958.
  27. Peto R, Pike MC, Armitage P, et al. Design and analysis of randomized clinical trials requiring prolonged observation of each patient, I, introduction and design. *Br J Cancer* 34:585–612, 1976.
  28. Hovi L, Saarinen-Pihkala UM, Vettenranta K, Lipsanen M, Tapanainen P. Growth in children with poor-risk neuroblastoma after regimens with or without total body irradiation in preparation for autologous bone marrow transplantation. *Bone Marrow Transplant* 24: 1131–1136, 1999.
  29. Neve V, Foot AB, Michon J, Fourquet A, Zucker JM, Boule M. Longitudinal clinical and functional pulmonary follow-up after megatherapy, fractionated total body irradiation, and autologous bone marrow transplantation for metastatic neuroblastoma. *Med Pediatr Oncol* 32:170–176, 1999.
  30. Olshan JS, Willi SM, Gruccio D, Moshang T Jr. Growth hormone function and treatment following bone marrow transplant for neuroblastoma. *Bone Marrow Transplant* 12: 381–385, 1993.
  31. Smedler AC, Bolme P. Neuropsychological deficits in very young bone marrow transplant recipients. *Acta Paediatr* 84:429–433, 1995.
  32. Kolb HJ, Bender-Gotze C. Late complications after allogeneic bone marrow transplantation for leukaemia. *Bone Marrow Transplant* 6:61–72, 1990.
  33. Atra A, Pinkerton C. Autologous stem cell transplantation in solid tumors of childhood. *Ann Med* 28:159–164, 1996.
  34. Shen V, Woodbury C, Killen R, van de Ven C, Sender L, Cairo MS. Collection and use of peripheral blood stem cells in young children with refractory solid tumors. *Bone Marrow Transplant* 19:197–204, 1997.
  35. Jones N, Williams D, Broadbent V, et al. High-dose melphalan followed by autograft employing non-cryopreserved peripheral blood progenitor cells in children. *Eur J Cancer* 32A:1938–1942, 1996.
  36. Weaver CH, West WH, Schwartzberg LS, et al. Induction, mobilization of peripheral blood stem cells (PBSC), high-dose chemotherapy and PBSC infusion in patients with untreated stage IV breast cancer: outcomes by intent to treat analyses. *Bone Marrow*

*Transplant* 19:661–670, 1997.

37. Leung W, Chen AR, Klann RC, et al. Frequent detection of tumor cells in hematopoietic grafts in neuroblastoma and Ewing's sarcoma. *Bone Marrow Transplant* 22:971–979, 1998.
38. Moss TJ. Tumor contamination in stem cell products from patients with neuroblastoma and breast cancer. *Bone Marrow Transplant* 18 (Suppl 1):S17, 1996.
39. Di Caro A, Bostrom B, Moss TJ, et al. Autologous peripheral blood cell transplantation in the treatment of advanced neuroblastoma. *Am J Pediatr Hematol Oncol* 16:200–206, 1994.
40. Dini G, Lanino E, Garaventa A, et al. Unpurged ABMT for neuroblastoma: AIEOP-BMT experience. *Bone Marrow Transplant* 7 (Suppl 2):92, 1991.
41. Evans AE, August CS, Kamani N, et al. Bone marrow transplantation for high risk neuroblastoma at the Children's Hospital of Philadelphia: an update. *Med Pediatr Oncol* 23: 323–327, 1994.
42. Garaventa A, Ladenstein R, Chauvin F, et al. High-dose chemotherapy with autologous bone marrow rescue in advanced stage IV neuroblastoma. *Eur J Cancer* 4:487–491, 1993.
43. Kamani N, August CS, Bunin N, et al. A study of thiotepa, etoposide and fractionated total body irradiation as a preparative regimen prior to bone marrow transplantation for poor prognosis patients with neuroblastoma. *Bone Marrow Transplant* 17:911–916, 1996.
44. Kushner BH, Gulati SC, Kwon JH, O'Reilly RJ, Exelby PR, Cheung NK. High-dose melphalan with 6-hydroxydopamine-purged autologous bone marrow transplantation for poor-risk neuroblastoma. *Cancer* 68:242–247, 1991.
45. Lazarus HM, Rowe JM, Goldstone AH. Does in vitro bone marrow purging improve the outcome after autologous bone marrow transplantation? *J Hematother* 2:457–466, 1993.
46. Rill DR, Santana VM, Roberts WM, et al. Direct demonstration that autologous bone marrow transplantation for solid tumors can return a multiplicity of tumorigenic cells. *Blood* 84:380–383, 1994.
47. Wang Y, Einhorn P, Triche TJ, Seeger RC, Reynolds CP. Expression of protein gene product 9.5 and tyrosine hydroxylase in childhood small round cell tumors. *Clin Cancer Res* 6:551–558, 2000.
48. Hank JA, Robinson RR, Surfus J, et al. Augmentation of antibody dependent cell mediated cytotoxicity following in vivo therapy with recombinant interleukin 2. *Cancer Res* 50:5234–5239, 1990.
49. Hank JA, Surfus J, Gan J, et al. Treatment of neuroblastoma patients with antiganglioside GD2 antibody plus interleukin-2 induces antibody-dependent cellular cytotoxicity against neuroblastoma detected in vitro. *J Immunother* 15:29–37, 1994.
50. Kushner BH, Cheung NK. GM-CSF enhances 3F8 monoclonal antibody-dependent cellular cytotoxicity against human melanoma and neuroblastoma. *Blood* 73:1936–1941, 1989.
51. Munn DH, Cheung NK. Interleukin-2 enhancement of monoclonal antibody-mediated cellular cytotoxicity against human melanoma. *Cancer Res* 47:6600–6605, 1987.
52. Barker E, Mueller BM, Handgretinger R, Herter M, Yu AL, Reisfeld RA. Effect of a chimeric anti-ganglioside GD2 antibody on cell-mediated lysis of human neuroblastoma



- cells. *Cancer Res* 51:144–149, 1991.
53. Cheung NK, Kushner BH, Cheung IY, et al. Anti-G(D2) antibody treatment of minimal residual stage 4 neuroblastoma diagnosed at more than 1 year of age. *J Clin Oncol* 16: 3053–3060, 1998.
  54. Cheung NK, Kushner BH, Yeh SDJ, Larson SM. 3F8 monoclonal antibody treatment of patients with stage 4 neuroblastoma: a phase II study. *Int J Oncol* 12:1299–1306, 1998.
  55. Frost JD, Hank JA, Reaman GH, et al. A phase I/IB trial of murine monoclonal anti-GD2 antibody 14.G2a plus interleukin-2 in children with refractory neuroblastoma: a report of the Children's Cancer Group. *Cancer* 80:317–333, 1997.
  56. Handgretinger R, Anderson K, Lang P, et al. A phase I study of human/mouse chimeric antiganglioside GD2 antibody ch14.18 in patients with neuroblastoma. *Eur J Cancer* 2: 261–267, 1995.
  57. Sondel PM, Hank JA. Combination therapy with interleukin-2 and antitumor monoclonal antibodies. *Cancer J Sci Am* 3 (Suppl 1):S121–S127, 1997.
  58. Yu AL, Uttenreuther-Fischer MM, Huang CS, et al. Phase I trial of a human-mouse chimeric anti-disialoganglioside monoclonal antibody ch14.18 in patients with refractory neuroblastoma and osteosarcoma. *J Clin Oncol* 16:2169–2180, 1998.
  59. Ulukaya E, Wood EJ. Fenretinide and its relation to cancer. *Cancer Treat Rev* 25:229–235, 1999.
  60. Costa A, De Palo G, Decensi A, et al. Retinoids in cancer chemoprevention: clinical trials with the synthetic analogue fenretinide. *Ann N Y Acad Sci* 768:148–162, 1995.
  61. Di Vinci A, Geido E, Infusini E, Giaretti W. Neuroblastoma cell apoptosis induced by the synthetic retinoid *N*-(4-hydroxyphenyl)retinamide. *Int J Cancer* 59:422–426, 1994.
  62. Mariotti A, Marcora E, Bunone G, et al. *N*-(4-hydroxyphenyl)retinamide: a potent inducer of apoptosis in human neuroblastoma cells. *J Natl Cancer Inst* 86:1245–1247, 1994.
  63. Ponzoni M, Bocca P, Chiesa V, et al. Differential effects of *N*-(4-hydroxyphenyl)retinamide and retinoic acid on neuroblastoma cells: apoptosis versus differentiation. *Cancer Res* 55:853–861, 1995.
  64. Maurer BJ, Metelitsa LS, Seeger RC, Cabot MC, Reynolds CP. Increase of ceramide and induction of mixed apoptosis/necrosis by *N*-(4-hydroxyphenyl)-retinamide in neuroblastoma cell lines. *J Natl Cancer Inst* 91:1138–1146, 1999.
  65. Oridate N, Suzuki S, Higuchi M, Mitchell MF, Hong WK, Lotan R. Involvement of reactive oxygen species in *N*-(4-hydroxyphenyl)retinamide-induced apoptosis in cervical carcinoma cells. *J Natl Cancer Inst* 89:1191–1198, 1997.
  66. Pienta KJ, Nguyen NM, Lehr JE. Treatment of prostate cancer in the rat with the synthetic retinoid fenretinide. *Cancer Res* 53:224–226, 1993.
  67. Cobleigh MA, Dowlathshahi K, Deutsch TA, et al. Phase I/II trial of tamoxifen with or without fenretinide, an analog of vitamin A, in women with metastatic breast cancer. *J Clin Oncol* 11:474–477, 1993.
  68. De Palo G, Veronesi U, Marubini E, et al. Controlled clinical trials with fenretinide in breast cancer, basal cell carcinoma and oral leukoplakia. *J Cell Biochem Suppl* 22:11–17, 1995.
  69. Costa A MW, Perloff M, Buranelli F, et al. Tolerability of the synthetic retinoid fenretinide (HPR). *Eur J Cancer* 25:805–808, 1989.

70. Bailey HH. L-S,R-buthionine sulfoximine: historical development and clinical issues. *Chem Biol Interact* 111–112:239–254, 1998.
71. Caffrey PB, Zhang Y, Frenkel GD. Rapid development of drug resistance in human ovarian tumor xenografts after a single treatment with melphalan in vivo. *Anticancer Res* 18: 3021–3025, 1998.
72. Rodriguez-Vicente J, Vicente-Ortega V, Canteras-Jordana M. The effects of different anti-neoplastic agents and of pretreatment by modulators on three melanoma lines. *Cancer* 82:495–502, 1998.
73. Anderson CP, Tsai J, Chan W, et al. Buthionine sulphoximine alone and in combination with melphalan (L-PAM) is highly cytotoxic for human neuroblastoma cell lines. *Eur J Cancer* 33:2016–2019, 1997.
74. Anderson CP, Tsai JM, Meek WE, et al. Depletion of glutathione by buthionine sulfoximine is cytotoxic for human neuroblastoma cell lines via apoptosis. *Exp Cell Res* 246:183–192, 1999.
75. Anderson CP, Seeger RC, Matthay KK, Neglia JP, Bailey HH, Reynolds CP. Pilot study of buthionine sulfoximine and melphalan in children with recurrent neuroblastoma. *Proc Am Soc Clin Oncol* 17:531A, 1998.
76. Shulkin BL, Shapiro B. Current concepts on the diagnostic use of MIBG in children. *J Nucl Med* 39:679–688, 1998.
77. Mastrangelo R, Tornesello A, Mastrangelo S. Role of <sup>131</sup>I-metaiodobenzylguanidine in the treatment of neuroblastoma. *Med Pediatr Oncol* 31:22–26, 1998.
78. Perel Y, Conway J, Kletzel M, et al. Clinical impact and prognostic value of metaiodobenzylguanidine imaging in children with metastatic neuroblastoma. *J Pediatr Hematol Oncol* 21:13–18, 1999.
79. Tepmongkol S, Heyman S. <sup>131</sup>I MIBG therapy in neuroblastoma: mechanisms, rationale, and current status. *Med Pediatr Oncol* 32:427–431; discussion 432, 1999.
80. Brans B, Laureys G, Schelfhout V, et al. Activity of iodine-123 metaiodobenzylguanidine in childhood neuroblastoma: lack of relation to tumour differentiation in vivo. *Eur J Nucl Med* 25:144–149, 1998.
81. Berthold F, Feine U, Fischer M, et al. [<sup>131</sup>I]-meta-iodobenzylguanidine treatment of 32 children with therapy-refractory neuroblastoma]. *Klin Padiatr* 200:226–229, 1988.
82. Garaventa A, Bellagamba O, Lo Piccolo MS, et al. <sup>131</sup>I-metaiodobenzylguanidine (<sup>131</sup>I-MIBG) therapy for residual neuroblastoma: a mono-institutional experience with 43 patients. *Br J Cancer* 81:1378–1384, 1999.
83. Goldberg SS, DeSantes K, Huberty JP, et al. Engraftment after myeloablative doses of <sup>131</sup>I-metaiodobenzylguanidine followed by autologous bone marrow transplantation for treatment of refractory neuroblastoma. *Med Pediatr Oncol* 30:339–346, 1998.
84. Klingebiel T, Bader P, Bares R, et al. Treatment of neuroblastoma stage 4 with <sup>131</sup>I-metaiodo-benzylguanidine, high-dose chemotherapy and immunotherapy: a pilot study. *Eur J Cancer* 34:1398–1402, 1998.
85. Matthay KK, DeSantes K, Hasegawa B, et al. Phase I dose escalation of <sup>131</sup>I-metaiodobenzylguanidine with autologous bone marrow support in refractory neuroblastoma. *J Clin Oncol* 16:229–236, 1998.

# **CHAPTER 4**

## **AUTOIMMUNE DISEASE**



# **Immunoablation Followed or Not by Hematopoietic Stem Cell Infusion as an Intense Therapy for Severe Autoimmune Diseases: New Perspectives, New Problems**

***Alberto M. Marmont***

*II Division of Hematology and Stem Cell Transplantation Centre,  
S. Martino's Hospital, Genoa, Italy*

## **INTRODUCTION**

Estimates of the prevalence of autoimmune diseases (ADs) in Western countries range from 3%<sup>1</sup> to 6%–7%<sup>2</sup> of the population. The list of ADs is increasing, mainly because of better insight into the pathogenesis of several diseases long considered to be of unknown origin. Establishing the autoimmune basis of human disease may occasionally be arduous, but satisfactory criteria have been repeatedly proposed<sup>3</sup> and are generally used. Although autoimmunity has been thought of as the persistent failure of an integrated fabric of components rather than the consequence of specific forbidden clones,<sup>4</sup> in practice, diseases may be confidently classified as autoimmune when they exhibit defined reactions against self-antigens as a major component of their pathogenesis. The intricacies of distinguishing between intrinsic and extrinsic etiologic and pathogenic mechanisms are compounded by the diversities inherent in each AD and even within the subsets of specific diseases.<sup>5</sup> It is not known whether the antibody response in systemic ADs is antigen-driven, such that the immune system is responding to self-proteins that have become autoantigenic,<sup>6</sup> or if ADs represent a primary dysfunction of the immune system.<sup>7</sup> The two hypotheses are not mutually exclusive, and the prevailing conception is that of a combination of genetic factors responding to environmental triggers,<sup>8</sup> these last including both exogenous and endogenous factors.

The majority of ADs are controlled, more or less satisfactorily, by conventional therapeutic manipulation of the immune system, but there is a hard core of refractory/relapsing, treatment-resistant<sup>9</sup> ADs for which the term “malignant autoimmunity” has appropriately been proposed.<sup>10</sup> As recently remarked by Mackay and Rose,<sup>11</sup> the holy grail of therapy is a targeted treatment that would specifically destroy the pathogenic clones responsible for ADs. That ideal remains unrealized.

Intense immunosuppression (immunoablation), followed by allogeneic or autologous hematolymphopoietic stem cell (HSC) transplantation, is a relatively new therapeutic approach, which I proposed for the first time for the treatment of severe, refractory systemic lupus erythematosus (SLE).<sup>12</sup> Immunoablation has produced encouraging results in patients with ADs who have undergone allogeneic bone marrow transplantation because of coincidental hematologic malignancies. A great deal of research had already produced impressive results using transplant-based procedures in experimental animals (see below). Suggestions to carry these encouraging results into the clinic soon followed.<sup>12,13</sup> Reports of allogeneic transplants for coincidental diseases (ADs and malignancies) were published. Phase 1 and 2 clinical studies have followed through the efforts of the European Group for Blood and Marrow Transplantation (EBMT), the European League Against Rheumatism (EULAR), and the National Collaborative Study of Stem Cell Transplantation for Autoimmune Diseases. A number of exhaustive reviews of the experimental<sup>14-16</sup> and clinical<sup>18,17-24</sup> aspects of these approaches have been published.

## RESULTS IN ANIMAL MODELS

This preclinical area is very extensive and cannot be discussed in depth here. Following the first demonstration of transfer/cure of murine SLE in 1974,<sup>25</sup> the most important results of these experimental studies concern (1) the identity of the cellular elements responsible for the transfer of autoimmunity, (2) a possible graft-vs.-autoimmunity effect following allotransplant, and (3) the therapeutic potential of autologous stem cell transplantation (autoSCT). The first point is still controversial. It has been proposed that ADs, or at least experimental ADs, are polyclonal stem cell diseases.<sup>15</sup>

An important therapeutic effect of allotransplant in leukemia and in other malignant diseases is the well-known graft-vs.-leukemia effect.<sup>26</sup> A putative graft-vs.-autoimmunity effect is supported by experiments showing that allogeneic chimerism achieved using a sublethal radiation conditioning regimen followed by allogeneic transplantation can prevent the onset of diabetes and even reverse preexisting insulinitis in nonobese diabetic mice, whereas the same radiation protocol without allogeneic HSC is insufficient.<sup>27</sup> A similar effect has been shown using sublethal conditioning and an anti-CD154 monoclonal antibody.<sup>28</sup> These experimental findings support low-conditioning preparative regimens for allogeneic transplants also in ADs.<sup>8,22,23</sup>

An unexpected but provocative finding<sup>14,16,21</sup> was that autologous (and pseudoautologous) HSC transplantation was equally effective in curing murine adjuvant arthritis<sup>29</sup> and experimental autoimmune encephalomyelitis,<sup>30</sup> although allogeneic transplants proved superior in curing the latter disease.

## CLINICAL RESULTS

### Posttransplant Autoimmunity

The term adoptive autoimmunity was proposed in 1992 to indicate the transfer of an autoimmune disorder from an HSC donor to a recipient.<sup>31</sup> If direct transmission of either pathogenetic lymphocytes or HSCs that generate auto-reactive clones from the donor can be demonstrated, the pathogenesis is clear. However, in many other instances, ADs can be attributed to the "immunological chaos"<sup>32</sup> or imbalance characterizing the posttransplant setting.

### Resolution of Preexisting Autoimmune Disease Following Allogeneic Bone Marrow Transplantation

In most such instances, patients with preexisting ADs have developed a malignant disease of the blood requiring transplantation. If acquired aplastic anemia were classified as a bona fide autoimmune disease,<sup>33</sup> then it would represent the most common autoimmune disorder to be treated by allogeneic transplantation. However, this is a special condition that will be not discussed here.

Nine patients with rheumatoid arthritis (RA) received allo-BMT from HLA-identical sibling donors for severe aplastic anemia (SAA) occurring after gold salt therapy. They have been reviewed extensively elsewhere.<sup>5,33-36</sup> All patients entered remission, although 3 died of transplant-related mortality (TRM). Of the remaining 5 patients, 3 are in complete remission from their arthritis (1 has been in complete remission for 20 years),<sup>35</sup> 1 developed a positive rheumatoid factor, and 1 relapsed 2 years after transplant even though the patient's immune system was 98.5% of donor origin.<sup>37</sup> Relapse was also observed in a patient with psoriasis and arthropathy following allogeneic transplantation.<sup>38</sup> The occurrence of relapse despite complete donor hematolymphopoietic reconstitution may be related to intrinsic susceptibility of the transplanted immune system (HLA-identical to the patient's) to powerful autoantigenic stimuli.

Between 1982 and 1992, 6 patients with Crohn's disease and leukemia underwent allogeneic marrow transplantation in Seattle, WA.<sup>39</sup> One patient died of septicemia 97 days after transplant; the remaining 5 were observed for several years posttransplant (4.5, 5.8, 8.4, 9.9, and 15.3 years). Four of these 5 evaluable patients had no signs or symptoms of Crohn's disease posttransplant. Only 1 patient with mixed donor-host hematopoietic chimerism had a relapse of both Crohn's disease and chronic myeloid leukemia 1.5 years after transplantation.

Two patients with Evans' syndrome (ES), a combination of autoimmune hemolytic anemia (AIHA) and immune thrombocytopenic purpura, have received allogeneic transplants.<sup>40</sup> A 5-year-old boy affected from infancy by relapsing, life-threatening ES was successfully transplanted with HLA-identical sibling cord

blood.<sup>41</sup> There was total disappearance of autoantibodies, but the patient died of liver failure 9 months posttransplant. A child with thalassemia intermedia developed AIHA severe enough to promote an autologous transplant, had a short-lived remission, relapsed with a dramatic recurrence of hemolysis, and finally was cured following allotransplant from an unrelated volunteer donor.<sup>42</sup> This might be the first clinical demonstration of the superior curing potential of allo- vs. autoSCT.

### **AUTOLOGOUS TRANSPLANTS FOR THE TREATMENT OF AUTOIMMUNE DISEASE**

Autologous HSC transplants, from marrow or now almost exclusively from peripheral blood, are much more commonly used to treat ADs than are allogeneic transplants for 2 reasons: the encouraging experimental results from Rotterdam<sup>14,29,30</sup> and Jerusalem,<sup>13,22</sup> and the greater safety of the autologous procedures.<sup>18,24,43,44</sup> TRM at 2 years posttransplant for ADs was 8.6%, which is comparable to the procedure-related mortality following transplantation for non-Hodgkin's lymphoma (NHL).<sup>45</sup>

Contributing factors to higher-than-expected TRM may have been a learning curve for using autoSCT in new diseases, hitherto unrecognized hazard associated with profound immunodeficiency, especially following intense T-cell depletion, and unique organ dysfunction, such as heart and lung failure in systemic sclerosis.<sup>46</sup> A brief recapitulation of published reports follows.

#### **Multiple Sclerosis**

Multiple sclerosis (MS) is characterized by demyelination, immunophlogistic lesions around axons, and ultimately axon loss. Pathogenesis is widely held as autoimmune,<sup>47,48</sup> with T-cell activity in the foreground.<sup>49</sup> It has become the most common disease treated by autoSCT, mostly because of extensive pioneering work by Fassas et al.<sup>50</sup> Following an initial report, 24 patients with MS in progressive phase were conditioned with the BEAM regimen (carmustine, etoposide, cytosine arabinoside, and melphalan). They then received autologous CD34<sup>+</sup> progenitors that had been previously mobilized by cyclophosphamide and granulocyte colony-stimulating factor (G-CSF). They were also conditioned with antithymocyte globulin to deplete lymphocytes *in vivo*. One patient died of aspergillosis in the posttransplant period; the other 23 patients sustained no severe transplant-related morbidity. Improvement in disability, as measured with the Kurtzke extended disability status scale (EDSS), was seen in 10 patients, and stabilization of MS occurred in 10 patients (43%). Following mobilization, there was a significant decrease of gadolinium-enhancing lesions on magnetic resonance imaging (MRI), and after autoSCT, of 132 scans, only 3 active lesions were found in 2 patients.<sup>51</sup> In



another clinical study, 6 MS patients were treated with a conditioning regimen of cyclophosphamide 20 mg/kg and total body irradiation (TBI) 12.6 Gy fractionated over 4 days. Peripheral blood CD34<sup>+</sup> cells were mobilized with G-CSF. All patients experienced subjective and objective neurologic improvement.<sup>52</sup> There were no new gadolinium-enhancing lesions detected after transplantation. Eleven patients were mobilized with cyclophosphamide 4 g/mg and G-CSF, and 8 of them were autografted following the usual BEAM protocol.<sup>53</sup> There were significant improvements by the EDSS scale and no fatalities. In addition to 2 autologous transplants, 1 patient with acute myeloid leukemia (AML) plus MS received an allogeneic transplant with stabilization of MS at 48 months, and another had a syngeneic transplant with stabilization of disease but no evidence of the oligoclonal bands in the cerebrospinal fluid that were present before transplantation.<sup>54</sup>

In an ongoing study by the Gruppo Italiano Trapianti di Midollo Osseo (GITMO)-Neuro Intergroup on Autologous Stem Cell Transplantation for Multiple Sclerosis, 10 cases of secondary progressive MS with EDSS initially between 5 and 6, a documented rapid progression over the last year unresponsive to conventional therapies, and the presence of gadolinium-enhancing areas on brain MRI using a triple dose of gadolinium<sup>55</sup> underwent CD34<sup>+</sup> mobilization and then autoSCT following conditioning with BEAM (G.L. Mancardi, R. Saccardi, M. Filippi, A.M.M., unpublished data). Ten cases have undergone autoSCT, with a median follow-up of 9 months (range, 2–30 months). No major serious adverse events were observed during or after treatment. Mobilization was successful in all cases, with a median of  $9.06 \times 10^6$  CD34<sup>+</sup> cells/kg collected. During the 3-month pretreatment period, number of gadolinium-enhancing areas/month per patient in the same period was 10.5 (range 1–38). The number of gadolinium-positive areas decreased dramatically after mobilization with cyclophosphamide and dropped into 0 in 10 cases within 1 month from conditioning with BEAM. All patients slightly improved clinically or remained stable. The median EDSS decreased to 6, and the median Scripps scale increased to 70. In the first case, MRI enhancing was still completely abrogated 30 months after transplantation. Although clinical amelioration/stabilization was observed, it was concluded that the final impact of this procedure on the natural history of the disease remains to be established in larger, possibly prospective randomized trials. Guidelines in a consensus report have been published.<sup>56</sup>

### **Rheumatoid Arthritis**

Following a dramatic amelioration in a single case,<sup>57</sup> 10 patients with RA have had autografts at St. Vincent's Hospital in Sydney, Australia, with no transplant-related mortality or serious toxicity.<sup>58</sup> Two cohorts of 4 patients, each with severe, active RA, received autologous unmanipulated HSCs following conditioning with

100 or 200 mg/kg cyclophosphamide<sup>59</sup>; the subablative doses produced only transient responses, and superior results were obtained with the highest dose of cyclophosphamide. However, in a prolonged study of 4 autologous transplant recipients with ADs (3 psoriasis, 1 RA) complicated by malignancies, ADs remitted in all patients but recurred at 8–24 months. It was suggested that a single autograft with non-T-cell-depleted HSC is unlikely to cure ADs.<sup>59</sup> In 4 patients with severe RA, mobilization with cyclophosphamide 4 g/mg was sufficient to confer significant improvement.<sup>60</sup> Four other patients were treated with cyclophosphamide 200 mg/m<sup>2</sup> and ATG 90 mg/kg, and in 1 patient TBI was administered. They were autotransplanted with T-cell-depleted (TCD) CD34<sup>+</sup> cells, but all relapsed, including the irradiated patient.<sup>61</sup> A 39-year-old patient is in CR following a syngeneic transplant, and his T-cell repertoire became almost identical with the donor's.<sup>62</sup> Exhaustive reviews have been published.<sup>34,36</sup>

### Juvenile Chronic Arthritis

Although the overall prognosis for children with juvenile chronic arthritis (JCA) is good, the disease is refractory and severely progressive in a small proportion of patients. Four such cases autotransplanted with marrow HSCs have been reported,<sup>63</sup> but others have followed. The grafts were purged with 2 cycles of TCD cells. The conditioning regimen included 4 days of ATG, cyclophosphamide 200 mg/kg, and low-grade (4 Gy) single-dose TBI. This intense conditioning regimen was well tolerated, and there was a substantial resolution of signs and symptoms of active disease, but there was also limited recurrence. One death was caused by posttransplant disseminated toxoplasmosis,<sup>64</sup> but others have also occurred. A so-called macrophage-activation syndrome has been described in these patients, but there is no reason to distinguish it from the well-known hemophagocytic lymphohistiocytosis.<sup>65,66</sup>

### Systemic Lupus Erythematosus

As originally suggested in 1993,<sup>12</sup> SLE is rapidly becoming another major target for autologous transplants. Four cases of concomitant SLE and malignancy have been published. They include chronic myeloid leukemia and SLE,<sup>67</sup> NHL and SLE,<sup>68</sup> and Hodgkin's disease and SLE.<sup>69</sup> In 1 case, the NHL did not relapse, but autoimmune thrombocytopenic purpura (AITP) supervened in association with an anticentromere antibody; the autoimmune disease thus appeared more refractory than the neoplasia.<sup>70</sup>

A number of nonconcomitant SLE patients have undergone autoSCT. Most of these cases have been reported in abstract form and will not be discussed here. The first 2 cases were published in 1997.<sup>71,72</sup> As of this writing, there are 4 fully

published cases of severe, relapsing/refractory SLE that have undergone intense immunosuppression followed by autoSCT. The first case, with a 50-month follow-up, was transplanted with positively selected CD34<sup>+</sup> marrow cells after conditioning with thiotepa and cyclophosphamide 50 mg/kg.<sup>71</sup> This patient is still in clinical remission 4 years after transplant, but there is a slow gradual reappearance of antinuclear antibodies (ANA), with a shift from a speckled to a homogeneous pattern. Also, antibodies to double-stranded DNA have appeared. In all the other cases, PBSCs were used following mobilization with cyclophosphamide/G-CSF; the cyclophosphamide dosage varied from 2 to 4 g/mg. In the Palermo case, the patient had refractory ES secondary to SLE that resolved after transplant.<sup>73</sup> The Paris case was conditioned with the BEAM regimen and had a continuous clinical remission, with a gradual reappearance of ANA.<sup>74</sup> In the most extensive clinical study published to date,<sup>75</sup> 9 patients underwent stem cell mobilization with cyclophosphamide 2 g/m<sup>2</sup> and G-CSF 10 mg/kg. Two were excluded from transplantation because of infection (1 death from disseminated mucormycosis), and 7 were autotransplanted after conditioning with cyclophosphamide 200 mg/kg, methylprednisolone 1 g, and equine antithymocyte globulin 90 mg/kg. All patients were seriously ill, with SLE disease activity indices of 17–37, including 1 case with alveolar hemorrhage and 4 with World Health Organization class III-IV glomerulonephritis and nephrotic syndrome. Lupus remained in clinical remission in all patients after transplant. ANA became negative, and spontaneous T-cell activation marker CD69 declined or normalized after transplantation.

### Systemic Sclerosis

Systemic sclerosis (SSc) of the diffuse type is a devastating disease in which pulmonary interstitial fibrosis is the most frequent cause of death.<sup>76</sup> Two transplants have been performed in Basel, Switzerland, using cyclophosphamide 200 mg/kg and CD34<sup>+</sup> cell rescue, with moderate benefit.<sup>77,78</sup> Five patients in Seattle, WA, received treatment with cyclophosphamide 120 mg/kg, TBI 8 Gy, and ATG 90 mg/kg followed by CD34<sup>+</sup> cell-selected autografts. The first 3 patients, followed for 13, 7, and 4 months, showed no evidence of disease progression. Their skin scores, mobility, skin ulcers, and arthralgias improved, with a trend toward improvement in pulmonary function, although in 1 patient renal function deteriorated. One patient developed grade III noninfectious pulmonary toxicity.<sup>79</sup>

To date, the most successful case of autologous transplantation for SSc is that of a 13-year-old girl with severe, progressive lung involvement who underwent peripheral HSC transplantation after mobilization with cyclophosphamide and G-CSF, CD34<sup>+</sup> selection, conditioning with cyclophosphamide 200 mg/kg, and infusion of the monoclonal antibody CAMPATH-G. Two years after transplan-

tation, progressive and marked improvement had occurred; the pulmonary ground-glass opacities disappeared, the patient was steroid independent, and there was an impressive improvement in growth velocity.<sup>80</sup> In contrast, antinuclear and anti-Scl-70 antibody positivity remained substantially unchanged.

### **Evans' Syndrome and Autoimmune Thrombocytopenic Purpura**

Refractory ES and refractory AITP that relapse after splenectomy and do not respond to corticosteroids are associated with substantial morbidity and mortality because of the combined effects of disease and treatment.<sup>81</sup> In a case report of a patient treated with autoSCT, a 25-year-old woman with ES received peripheral blood stem cell mobilization with routine doses of 4 g/m<sup>2</sup> cyclophosphamide and G-CSF; this was followed by exacerbation of hemolysis and thrombocytopenia, and the patient died of an intracranial hemorrhage.<sup>82</sup>

Four cases of refractory postsplenectomy relapsed AITP have been treated with intensive immunosuppression followed by autoSCT. The first 2 cases responded dramatically<sup>83</sup> but then relapsed (S. Lim, personal communication). The other 2 cases did not respond at all.<sup>84,85</sup>

## **SPECIAL ISSUES**

### **Conditioning**

The main conditioning regimens are well known, and include cyclophosphamide 200 mg/kg over 4 days, the variant with thiotepa used in Genoa, Italy, and the equally well-known BEAM protocol, which has been found attractive for MS because of its intense lympholytic effect and the capability of BCNU and Ara-C metabolites to cross the (already disrupted) blood-brain barrier. Although the combination of chemotherapy with TBI has been shown to be a significant risk factor for developing therapy-related AML/myelodysplastic syndrome (MDS),<sup>86</sup> van Bekkum<sup>87</sup> is of the opinion that the combination with moderate-dose TBI is superior to chemotherapy alone. As already mentioned, this combination has been used for JCA.<sup>63</sup>

### **Intense Immunosuppression Without HSC Rescue for Treatment of Autoimmune Disease**

Treatment with high-dose cyclophosphamide alone (200 mg/kg) has been used to treat SAA<sup>88</sup> and has subsequently been extended to a spectrum of severe ADs<sup>89</sup> including Felty's syndrome (2 cases), AITP and ES (1 case each), and SLE. One patient with AITP experienced disease progression and died following high-dose

cyclophosphamide. A patient with refractory demyelinating polyneuropathy that had been refractory to plasmapheresis had a complete remission. Hematologic reconstitution was similar to that generally found after autologous HSC rescue. This has been attributed to the fact that primitive HSCs express high levels of aldehyde dehydrogenase, an enzyme responsible for cellular resistance to cyclophosphamide.<sup>90</sup>

Six patients with severe, relapsing SLE have also been treated with this regimen. Two are in complete, steroid-independent remission, 1 is in a partial remission, and 3 are showing dramatic improvement (although follow-up is currently less than 6 months). In 1 case of SLE,<sup>91</sup> the inadvertent administration of a single high dose of cyclophosphamide (5 g) resulted in a sustained remission, further confirming the efficacy of cyclophosphamide alone. However, the use of high-dose cyclophosphamide without potential backup of cryopreserved stem cells could turn out to be hazardous in the context of multicenter trials.<sup>36</sup> The *ex vivo* expansion of progenitors, on the other hand, could significantly shorten the duration of neutropenia,<sup>92</sup> as has been impressively shown in patients autotransplanted for multiple myeloma.<sup>93</sup>

### **Use of T-Cell Depletion Before HSC Infusion in Patients With Autoimmune Disease**

Depletion of T lymphocytes has been widely used in allotransplantation to reduce the incidence and severity of graft-vs.-host disease following allogeneic HSC transplants. Unfortunately, TCD is accompanied by many disadvantages, including rise in graft rejection, leukemic relapse, and delayed immunologic reconstitution. New approaches that are being studied include the use of a higher proportion of donor HSCs, selective T-cell subset depletion, and posttransplantation donor lymphocyte infusions (DLIs). Because patients with active ADs are not in complete remission at the time of transplantation, van Bekkum<sup>16,21</sup> considers it mandatory to deplete the autograft of autoreactive lymphocytes. Most ADs are T-cell mediated, and B-cell-mediated ADs<sup>6,94</sup> often display prominent T-cell dependency. Thus, TCD may be useful in the treatment of ADs. Theoretically, both activated and memory T (and B) lymphocytes should be eradicated, or at least maximally depleted. This can be achieved either by positive CD34<sup>+</sup> selection or by immunologic TCD. In addition, TCD has been performed *in vivo* by administering ATG to the recipients. There is no indication of a potential threshold dose of T cells acceptable for reinfusion. A 3-log depletion has been customary, but further depletion has been performed recently.<sup>63,74</sup> However, marked TCD may be accompanied by late fungal and viral infections and lymphoproliferative disease. There seems little point in curing ADs at the cost of profound and permanent immunosuppression.<sup>95</sup>

## Immune Reconstitution Following Stem Cell Transplantation

Reconstitution of the immune system following either allogeneic or autologous transplantation has been studied extensively. Exhaustive reviews have been published.<sup>96,97</sup>

The most common immunologic feature, also seen after intense chemotherapy, is a severe prolonged depression of CD<sup>+</sup> T cells,<sup>53,58,70,96–98</sup> although in some cases CD3<sup>+</sup> T cells have returned to pretransplantation levels after 10 months without disease relapse.<sup>99</sup> Age, prior TCD, radiation, and other factors may all modulate thymic or extrathymic pathways and influence the rate and extent of T-cell recovery after transplantation. The sites of lymphoid reconstitution, whether thymic or extrathymic, in young and older patients have been the subject of an abundant and frequently controversial literature.<sup>96–100</sup> The thymic output in adults following autoSCT has been studied very recently using the numbers of T-cell receptor–rearrangement excision circles (TRECs) in peripheral blood T cells.<sup>101</sup> It was found that increases in concentrations of TREC posttransplant were associated with the development of broader CD4 T-cell TREC repertoires, and that patients with no increases in TRECs had limited and highly skewed repertoires. The relative importance of thymus-dependent and thymus-independent pathways in adults is still controversial. The expanding CD4<sup>+</sup> T-cell population may exhibit increased susceptibility to apoptosis.<sup>102</sup> It appears that the infusion of large numbers of PBSCs is also not sufficient for T-cell immune competence, with special reference to the CD4<sup>+</sup> subpopulation.<sup>103</sup>

## DISCUSSION

Prevailing concepts of autoimmunity dictate that a stable cure of ADs can be expected only if the patients' autoreactive immunocompetent cells are replaced by healthy, nonautoreactive cells. The healthy immune cells must also remain unsusceptible to whatever phenomenon provoked the initial breakdown in tolerance.<sup>22</sup> Of the 3 approaches discussed here—allogeneic HSC transplantation, autologous HSC rescue following intense immunosuppression, and intense immunosuppression alone—allogeneic HSC transplantation is theoretically the most promising. Allogeneic transplants have generally been followed by long-term remissions and possible cures. However, mortality and morbidity associated with allogeneic transplantation, although decreasing steadily in other disease contexts,<sup>104</sup> are still unacceptable for most ADs. In addition, there are reports of patients with RA relapsing despite complete or nearly complete donor immunologic reconstitution following allogeneic transplantation.<sup>37,38</sup> Leukemia relapse in donor cells is rare, but there are established occurrences following transplantation. Transfection and/or chromosomal fusion have been considered as

possible explanations, but those seem improbable in the autoimmune setting, where extrinsic events such as re-sensitization to autoantigens appear more likely. If relapses following allogeneic transplantation for ADs continue to be observed, the theoretical edge of an allogeneic procedure over an autologous transplant would be considerably weakened.<sup>23</sup> However, the case report of a severe autoimmune hemolytic anemia having relapsed after autoSCT but having achieved long-term clinical and immunological CR following a matched unrelated donor allo-transplant<sup>80</sup> is encouraging.

The recent introduction of minimally myelosuppressive regimens, which avoid the devastating cytokine storm associated with classic dose-intensive conditioning regimens and exploit donor lymphocyte immune effects, are a promising development in the treatment of malignant and nonmalignant diseases.<sup>104–107</sup> If a graft-vs.-autoimmunity effect were to occur clinically, it might also prevent recapitulation of disease.<sup>23,108</sup> The simplest explanation for a similar effect consists in the progressive substitution of normal T and B cells in the place of autoreactive lymphocytes. However, a selective elimination by cytotoxic lymphocytes of target autoimmune progenitor cells could also be envisaged, as has been elegantly shown in the case of CD34<sup>+</sup> chronic myeloid leukemia progenitors.<sup>109</sup>

In the rare setting of an identical twin nonconcordant for disease, a syngeneic transplant may be considered. A dramatic result following a syngeneic transplant in a patient with severe RA has been published.<sup>62</sup> In the case of SLE, only 23% of 66 monozygotic twins were found to be concordant for disease,<sup>110</sup> although a higher concordance has also been reported.<sup>111</sup> Concordance of antibody production is higher than disease concordance.<sup>112</sup> Also, cord blood stem cells<sup>43</sup> may become an attractive option for the treatment of ADs.

Autologous transplantation has been hailed as a possible therapy for severe refractory ADs because of its lower transplant-related mortality and greater feasibility.<sup>5,18,24,40</sup> In the EBMT registry, the overall survival at 2 years was 89% ± 7%, with a median follow-up of 10 months for surviving patients. The transplant-related mortality at 2 years was 8% ± 6%, which is comparable to that associated with autoSCT for malignant disease.<sup>45</sup> Selection of patients with less severe disease could further reduce mortality, but on the other hand, one must consider that the procedure is meant for refractory/relapsing patients who often have accumulated diffuse visceral damage.

Peripheral blood HSCs are generally preferred to marrow HSCs in almost all clinical situations, but very high doses of cyclophosphamide for mobilization should be discouraged. A dose of 4 g/m<sup>2</sup> is generally used with adequate mobilization and minimal toxicity. These cyclophosphamide doses are immunosuppressive and may contribute to the efficacy of transplantation, as was clearly shown in MS (G.L. Mancardi, R. Saccardi, M. Filippi, A.M.M., unpublished data)<sup>51,53</sup> and RA.<sup>60</sup>

A hitherto unsolved but fundamental question is whether intense immune suppression followed by autoSCT is indeed capable of eradicating autoimmunity and thus inducing tolerance, or if the immune system remains fundamentally unaltered and the so-called transplant is nothing more than a hematopoietic rescue. The first goal appears to have been achieved experimentally,<sup>17,22</sup> but in clinical settings what has been called “reprogramming the immune system”<sup>113</sup> has not been yet demonstrated. In SLE, it has been proposed that the conditioning, with concurrent use of ATG, might provide “a window of time free of memory T-cell influence, during which the maturation of new lymphocyte progenitors may occur without recruitment to anti-self reactivity.”<sup>75</sup> To elucidate whether disease (if relapses occur) is reinitiated by lymphocytes surviving the conditioning regimen or from the stem cell compartment, sophisticated studies with gene-marked autologous stem cells are being performed.<sup>114</sup> If the concept of Shoenfeld,<sup>115</sup> an idiotypic induction of autoimmunity, is shown as part of the etiology of SLE and other ADs, the impact of all these treatments would need further evaluation. Empirically, however, long-term remissions and relapses may also depend on the single disease and patient, but in most cases there is a distinct lowering of therapy dependence, in addition to the resolution of severe/acute autoimmune crises. Whether this effect will prove to be superior to other immunosuppressive and/or immunomodulating treatments will have to be evaluated in prospective randomized trials, notwithstanding the problems inherent to recruit sufficient numbers of homogeneous patients. This may well be feasible in not-infrequent diseases such as MS and RA, but will present many difficulties in other diseases such as SLE.

Even though the problem of the currently excessive TRM will be almost certainly solved, the issue of late oncogenicity cannot be ignored, especially in younger patients with nonmalignant diseases.<sup>86</sup> The risk of developing solid cancers was 3–4 times higher in patients treated with combined modality therapy during marrow transplantation than in controls.<sup>116</sup> In 1 study, a higher risk of AML was found following autoSCT when the conditioning regimens included TBI.<sup>117</sup> In addition, some of these patients may have already been treated with prior chemotherapy, including administration of large doses of alkylating agents, which has been shown to be the most important risk factor for developing AML/MDS. Preliminary cytogenetic screening could be useful to exclude patients already bearing chromosomal abnormalities.

Finally, investigations using prospective randomized studies must be initiated. For example, in JCA, transplantation results should be compared with the prolonged cyclophosphamide pulse program that has been used recently.<sup>118</sup>

In other diseases, such as MS, posttransplant treatment with  $\beta$ -interferon could perhaps prolong transplant-induced remissions.<sup>119</sup> Even if autoSCT has failed to produce clinical results comparable to the results achieved in animal models, some significant results have been achieved and future benefits are likely.



## CONCLUSIONS

The excellent experimental results obtained with allogeneic and even autologous stem cell transplantation for ADs have given considerable impetus to similar treatments for refractory/relapsing patients with severe ADs. Encouraging results following allogeneic stem cell transplantation have been reported in small numbers of patients with coexisting ADs and malignancies. However, a few relapses have occurred despite donor immune cell engraftment. If a graft-vs.-autoimmunity effect is confirmed, nonmyeloablative allogeneic procedures could become extremely useful. In the meantime, autologous transplantation using peripheral blood stem cells is currently performed worldwide to treat ADs. Results are encouraging, but remissions, rather than cures, have been obtained. In some diseases, especially MS, results are superior to those obtained with conventional therapies. Long-term remissions have also been obtained by intense immunosuppression alone, demonstrating that autologous stem cells have mainly a rescue effect. Further clinical trials are clearly warranted.

## REFERENCES

1. Jacobson DL, Gange SJ, Rose NR, Graham NMH. Epidemiology and estimated population burden of selected autoimmune diseases in the United States. *Clin Immunol Immunopathol* 84:223–243, 1997.
2. Sinha AA, Lopez MT, McDevitt HO. Autoimmune diseases: the failure of self-tolerance. *Science* 248:1380–1385, 1990.
3. Rose NR. Foreword: the use of autoantibodies. In: Peter JB, Shoenfeld Y, eds. *Autoantibodies*. Amsterdam, The Netherlands: Elsevier, 1996, p. xxvii–ix.
4. Shoenfeld Y, Isenberg O. *The Mosaic of Autoimmunity*. Amsterdam, The Netherlands: Elsevier, 1989.
5. Marmont AM. Stem cell transplantation for severe autoimmune disorders, with special reference to rheumatic diseases. *J Rheumatol* 24 (Suppl 48):13–18, 1997.
6. Tan EM. Autoantibodies and autoimmunity: a three decade perspective [review]. *Ann N Y Acad Sci* 815:1–14, 1997.
7. Coutinho A. An outsider's view on SLE research. *Lupus* 8:171–173, 1999.
8. Nash RA. Prospects of stem cell transplantation in autoimmune diseases. *J Clin Immunol* 20:38–45, 2000.
9. Cash JM, Wilder RL, eds. Treatment-Resistant Rheumatic Disease. *Rheum Dis Clin N Am* 21:1–170, 1995.
10. Lafferty KL, Gazda LS. Costimulation and the regulation of autoimmunity. In: Rose NR, ed. *The Autoimmune Diseases*. San Diego, CA: Academic, 1998, Chapter 5.
11. Mackay IR, Rose NR. Autoimmunity yesterday, today and tomorrow. In: Rose NR, ed. *The Autoimmune Diseases*. San Diego, CA: Academic, 1998, p. 849–872.
12. Marmont AM. Immunoablation with stem cell rescue: a possible cure for systemic lupus erythematosus. *Lupus* 2:151–156, 1993.

13. Slavin S. Treatment of life-threatening autoimmune disease with myeloablative doses of immunodepressive agents: experimental background and rationale for ABMT. *Bone Marrow Transplant* 12:201–210, 1993.
14. Van Bekkum DW. BMT in experimental autoimmune diseases [review]. *Bone Marrow Transplant* 11:183–187, 1993.
15. Ikehara S. Bone marrow transplantation for autoimmune diseases. *Acta Haematol* 99:116–132, 1998.
16. Van Bekkum DW. Stem cell transplantation in experimental models of autoimmune disease. *J Clin Immunol* 20:11–17, 2000.
17. Snowden JA, Brooks PM, Biggs JC. Haematopoietic stem cell transplantation for autoimmune diseases. *Br J Haematol* 99:9–22, 1997.
18. Marmont AM. Stem cell transplantation for severe autoimmune diseases: progress and problems. *Haematologica* 83:733–743, 1998.
19. Sherer Y, Schoenfeld Y. Stem cell transplantation: a cure for autoimmune diseases. *Lupus* 7:137–140, 1998.
20. Burt RK, Traynor A. Hematopoietic stem cell therapy of autoimmune diseases. *Curr Opin Hematol* 5:472–477, 1998.
21. Van Bekkum DW. New opportunities for treatment of severe autoimmune diseases: bone marrow transplantation [review]. *Clin Immunol Immunopathol* 89:1–10, 1998.
22. Slavin S. Autologous and allogeneic stem cell transplantation for the treatment of autoimmune diseases as a potential new approach. In: Schoenfeld Y, ed. *The Decade of Autoimmunity*. Amsterdam, The Netherlands: Elsevier, 1999, p. 399–408.
23. Marmont AM. New horizons in the treatment of autoimmune diseases: immunoablation and stem cell transplantation. *Ann Rev Med* 51:115–134, 2000.
24. Burt R, Rowlings PH, Traynor A. Hematopoietic stem cell transplantation for severe autoimmune disease: know thyself. In: Ball E, Lister J, Law P, eds. *Hematopoietic Stem Cell Therapy*. New York, NY: Churchill Livingstone, 2000, p. 203–215.
25. Morton JL. Transplantation of autoimmune potential. I: Development of antinuclear antibodies in H-2 histocompatible recipients of bone marrow from New Zealand Black mice. *Proc Natl Acad Sci U S A* 71:2162–2165, 1974.
26. Schlomchick WD, Emerson SG. The immunobiology of T cell therapies for leukemias. *Acta Haematol* 96:189–213, 1996.
27. Li H, Kaufman CL, Boggs SS, et al. Mixed allogeneic chimerism induced by a sublethal approach prevents autoimmune diabetes and reverses insulinitis in nonobese diabetic (NOD) mice. *J Immunol* 156:380–387, 1996.
28. Jeung E, Iwakoshi N, Woda BA, et al. Allogeneic hematopoietic chimerism in mice treated with sublethal myeloablation and anti-CD154 antibody: absence of graft-versus-host disease, induction of skin allograft tolerance, and prevention of recurrent autoimmunity in islet-allografted NOD/Lt mice. *Blood* 95:2175–2182, 2000.
29. Knaan-Shanzer S, Houben P, Kinwel-Bohre EBM, van Bekkum DW. Remission induction of adjuvant arthritis in rats by total body irradiation and autologous bone marrow transplantation. *Bone Marrow Transplant* 8:333–338, 1992.
30. Van Gelder M, van Bekkum DW. Effective treatment of relapsing autoimmune encephalomyelitis with pseudoautologous bone marrow transplantation. *Bone Marrow*

- Transplant* 18:1029–1034, 1996.
31. Marmont AM. Autoimmunity and bone marrow transplantation. *Bone Marrow Transplant* 9:1–3, 1992.
  32. Sherer Y, Shoenfeld Y. Autoimmune diseases and autoimmunity post-bone marrow transplantation. *Bone Marrow Transplant* 22:873–881, 1998.
  33. Young NS. Hematopoietic cell destruction by immune mechanisms in acquired aplastic anemia. *Semin Hematol* 37:3–14, 2000.
  34. Tyndall A, Milliken S. Bone marrow transplantation for rheumatoid arthritis. In: Van Riel PL, Bresnihan B, Eds. Established Rheumatoid Arthritis. *Baillères Best Pract Res Clin Rheumatol* 13:719–735, 1999.
  35. Nelson JL, Torrez R, Louie FM, et al. Pre-existing autoimmune disease in patients with long term survival after allogeneic bone marrow transplantation: Seattle experience. *J Rheumatol* 24 (Suppl 48):23–29, 1997.
  36. Lowenthal RM, Graham SR. Does hemopoietic stem cell transplantation have a role in treatment of severe rheumatoid arthritis? *J Clin Immunol* 20:17–23, 2000.
  37. McKendry RJR, Huebsch L, Le Clair B. Progression of rheumatoid arthritis following bone marrow transplantation: a case report with 13-years follow-up. *Arthritis Rheum* 39:1246–1253, 1996.
  38. Snowden JA, Kearney P, Keraney A, et al. Long-term outcome of autoimmune disease following allogeneic bone marrow transplantation. *Arthritis Rheum* 41:453–459, 1998.
  39. Lopez Cubero SO, Sullivan KM, McDonald GB. Course of Crohn's disease after allogeneic bone marrow transplantation: report of 6 cases. *Gastroenterology* 114:433–440, 1998.
  40. Marmont AM. Immune ablation and stem cell transplantation for severe Evans syndrome and refractory thrombocytopenic purpura [editorial]. *Bone Marrow Transplant* 23:1215–1216, 1999.
  41. Raetz E, Beatty PG, Rose J. Treatment of severe Evans' syndrome with an allogeneic cord blood transplant. *Bone Marrow Transplant* 20:427–429, 1997.
  42. Di Stefano P, Zecca M, Giorgiani G, et al. Resolution of immune hemolytic anaemia with allogeneic bone marrow transplantation after unsuccessful autograft. *Br J Haematol* 106:1063–1064, 1999.
  43. Tyndall A, Gratwohl A. Blood and marrow stem cell transplantation in autoimmune diseases: a consensus report written on behalf of European League against Rheumatism (EULAR) and the European Group for Blood and Marrow Transplantation. *Bone Marrow Transplant* 19:643–645, 1997.
  44. Marmont AM, Tyndall A, Gratwohl A, Vischer A. Haemopoietic precursor-cell transplants for autoimmune diseases. *Lancet* 345:978, 1995.
  45. Tyndall A, Fassas A, Passweg J, et al. Autologous hematopoietic stem cell transplantation for autoimmune disease-feasibility and transplant-related mortality. *Bone Marrow Transplant* 24:729–734, 1999.
  46. McSweeney PA, Furst DE, West SG. High-dose immunosuppressive therapy for rheumatoid arthritis: some answers, more questions [editorial]. *Arthritis Rheum* 42:2269–2274, 1999.
  47. Steinman L. Multiple sclerosis: a coordinated immunological attack against myelin in the central nervous system. *Cell* 85:299–302, 1996.

48. Gulcher JR, Varranian T, Stefansson K. Is multiple sclerosis an autoimmune disease? *Clin Neurosci* 2:246–252, 1994.
49. Hohfeld R, Londi M, Massacesi L, Salvetti M. T-cell immunity in multiple sclerosis. *Immunol Today* 16:259–261, 1995.
50. Fassas A, Anagnostopoulos A, Kazis A, et al. Peripheral blood cell transplantation in the treatment of progressive multiple sclerosis: first results of a pilot study. *Bone Marrow Transplant* 20:631–638, 1997.
51. Fassas A, Anagnostopoulos A, Kazis A, et al. Autologous stem cell transplantation in progressive multiple sclerosis: an interim analysis of efficacy. *J Clin Immunol* 20:24–30, 2000.
52. Burt RK, Traynor A, Pope R, et al. Treatment of autoimmune disease by intense immunosuppressive conditioning and autologous hematopoietic stem cell transplantation. *Blood* 92:3505–3514, 1998.
53. Kozak T, Hardova E, Pit'ha J, et al. High-dose immunosuppressive therapy with PRBC support in the treatment of poor risk systemic sclerosis. *Bone Marrow Transplant* 25:525–531, 2000.
54. Mandalfino P, Rice G, Smith A, et al. Bone marrow transplantation in multiple sclerosis. *J Neurol* 415:1–5, 2000.
55. Filippi M, Rovaris M, Capra R, et al. A multi-center longitudinal study comparing the sensitivity of monthly MRI after standard and triple dose gadolinium-DTPA for monitoring disease activity in multiple sclerosis. *Brain* 121:2011–2020, 1998.
56. Comi G, Kappos L, Clanet M, et al. Guidelines for autologous blood and marrow stem cell transplantation in multiple sclerosis: a consensus report written on behalf of the European Group for Blood and Marrow Transplantation and the European Charcot Foundation. *J Neurol* 247:376–382, 2000.
57. Joske DJ, Ma DTS, Langland DR, Owen ET. Autologous bone marrow transplantation for rheumatoid arthritis. *Lancet* 350:337–338, 1997.
58. Snowden JA, Biggs JC, Milliken ST, et al. A randomized, blinded, placebo-controlled, dose escalation study of the tolerability and efficacy of filgrastim for hematopoietic stem cell mobilisation in patients with severe active rheumatoid arthritis. *Bone Marrow Transplant* 22:1035–1041, 1998.
59. Snowden JA, Biggs JC, Milliken ST, et al. A phase I-II escalation study of intensified cyclophosphamide and autologous blood stem cell rescue in severe, active rheumatoid arthritis. *Arthritis Rheum* 42:2286–2292, 1999.
60. Breban M, Dougados M, Picard F, et al. Intensified dose (4 mg/m<sup>2</sup>) cyclophosphamide and granulocyte colony-stimulating factor administration for hematopoietic stem cell mobilisation in refractory rheumatoid arthritis. *Arthritis Rheum* 42:2275–2280, 1999.
61. Burt RK, Georganas C, Schroeder J, et al. Autologous hematopoietic stem cell transplantation in refractory rheumatoid arthritis. *Arthritis Rheum* 42:2281–2285, 1999.
62. McColl G, Kashaka H, Wicks I. High-dose chemotherapy and syngeneic hematopoietic stem-cell transplantation for severe, seronegative rheumatoid arthritis. *Ann Intern Med* 131:507–509, 1999.
63. Wulfraat N, van Royen A, Bierling M, et al. Autologous haematopoietic stem cell transplantation in four patients with refractory juvenile chronic arthritis. *Lancet* 353:550–553, 1999.

64. Quartier P, Prieur AM, Fischer A. Haematopoietic stem cell transplantation for juvenile chronic arthritis. *Lancet* 353:1883–1884, 1999.
65. Marmont AM, Spriano M. Hemophagocytic lymphohistiocytosis: still a morphological diagnosis. *Haematologica* 80:480–481, 1995.
66. Janka G, Imashuku S, Elinder G, et al. Infection- and malignancy-associated hemophagocytic syndromes: secondary hemophagocytic lymphohistiocytosis. *Hematol Oncol Clin N Am* 12:435–444, 1998.
67. Meloni G, Capria S, Vignetti M, Mandelli F. Blast crisis of chronic myelogenous leukemia in long-lasting systemic lupus erythematosus: regression of both diseases after autologous bone marrow transplantation [letter]. *Blood* 89:4650, 1997.
68. Snowden JA, Patton WN, O'Donnell JAL, et al. Prolonged remission of long-standing lupus erythematosus after autologous bone marrow transplant for non-Hodgkin's lymphoma. *Bone Marrow Transplant* 19:1247–1250, 1997.
69. Schachna L, Ryan PF, Schwarzer AP. Malignancy-associated remission of systemic lupus erythematosus maintained by autologous peripheral blood stem cell transplantation. *Arthritis Rheum* 41:2271–2272, 1998.
70. Euler HH, Marmont AM, Bacigalupo A, et al. Early recurrence or persistence of autoimmune disease after unmanipulated autologous stem cell transplantation. *Blood* 88:3621–3625, 1996.
71. Marmont AM, van Lint MT, Gualandi F, Bacigalupo A. Autologous marrow stem cell transplantation for systemic lupus erythematosus of long duration. *Lupus* 2:151–156, 1997.
72. Burt RK, Traynor AE, Ramsey-Goldman R. Hematopoietic stem cell transplantation for systemic lupus erythematosus [letter]. *N Engl J Med* 357:1777–1778, 1997.
73. Musso M, Porretto F, Crescimanno A, et al. Autologous peripheral blood stem and progenitor (CD34<sup>+</sup>) cell transplantation for systemic lupus erythematosus complicated by Evans syndrome. *Lupus* 7:492–494, 1998.
74. Fouillard L, Gorin NC, Laporte JP, et al. Control of severe systemic lupus erythematosus after high-dose immunosuppressive therapy and transplantation of CD34<sup>+</sup> purified autologous stem cell from peripheral blood. *Lupus* 8:320–323, 1999.
75. Traynor AE, Schroeder J, Rosa RM, et al. Treatment of severe systemic lupus erythematosus with high dose chemotherapy and haemopoietic stem-cell transplantation: a phase I study. *Lancet* 356:701–707, 2000.
76. Medsger TA, Steen VD. Classification, prognosis. In: Clements PJ, Furst DE, eds. *Systemic Sclerosis*. Baltimore, MD: Williams & Wilkins, 1996, p. 51–64.
77. Tamm M, Gratwohl A, Tichelli A, et al. Autologous haematopoietic stem cell transplantation in a patient with severe pulmonary hypertension complicating connective tissue disease. *Ann Rheum Dis* 55:779–780, 1996.
78. Tyndall A, Black C, Finke J, et al. Treatment of systemic sclerosis with autologous haematopoietic cell transplantation [letter]. *Lancet* 349:254, 1997.
79. McSweeney PA, Furst DE, Storek J, et al. High-dose immunosuppressive therapy (HDIT) using total body irradiation (TBI), cyclophosphamide (CY) and ATG with autologous CD34<sup>+</sup> selected peripheral blood stem cell (PBSC) rescue as treatment for severe systemic sclerosis [abstract]. *Blood* 92 (Suppl):295, 1998.

80. Martini A, Maccario R, Ravelli A, et al. Marked and sustained improvement two years after autologous stem cell transplantation in a girl with systemic sclerosis. *Arthritis Rheum* 42:807–811, 1999.
81. McMillan R. Therapy for adults with refractory chronic immune thrombocytopenic purpura. *Ann Intern Med* 126:307–314, 1997.
82. Martino R, Sureda A, Brunet S. Peripheral blood stem cell mobilization in a refractory autoimmune Evans syndrome: a cautionary case report. *Bone Marrow Transplant* 20:521, 1997.
83. Lim SH, Kell J, Al-Sabah A, et al. Peripheral blood stem-cell transplantation for refractory autoimmune thrombocytopenia [letter]. *Lancet* 40:475, 1997.
84. Skoda RC, Tichelli A, Tyndall A, et al. Autologous peripheral blood stem cell transplantation in a patient with chronic autoimmune thrombocytopenia. *Br J Haematol* 99:56–57, 1997.
85. Marmont AM, van Lint MT, Occhini D, et al. Failure of autologous stem cell transplantation in refractory thrombocytopenic purpura. *Bone Marrow Transplant* 22: 827–828, 1998.
86. Pedersen-Bjergaard J, Andersen MK, Christiansen DH. Therapy-related acute myeloid leukemia and myelodysplasia after high-dose chemotherapy and autologous stem cell transplantation. *Blood* 95:3273–3279, 2000.
87. Van Bekkum DW. Conditioning regimens for the treatment of experimental arthritis with autologous bone marrow transplantation. *Bone Marrow Transplant* 25:357–364, 2000.
88. Brodsky RA, Sensenbrenner LL, Jones RL. Complete remission in severe aplastic anemia after high dose cyclophosphamide without bone marrow transplantation. *Blood* 87: 491–494, 1996.
89. Brodsky RA, Petri M, Douglas Smith B, et al. Immunoablative high dose cyclophosphamide without stem cell rescue for refractory, severe autoimmune disease. *Ann Intern Med* 129:1031–1035, 1998.
90. Jones RJ, Collector MI, Barber JP, et al. Characterization of mouse lymphohematopoietic stem cells lacking spleen colony-forming activity. *Blood* 88:487–491, 1996.
91. Mittal G, Balarishna C, Mangat G, et al. “Sustained remission” in a case of SLE following megadose cyclophosphamide. *Lupus* 8:77–80, 1998.
92. Pecora AL. CD34<sup>+</sup> cell selection and ex vivo expansion in autologous and allogeneic transplantation. In: Rowe JM, Lazarus HM, Carella AM, eds. *Bone Marrow Transplantation*. London, UK: Dunitz, 2000, p. 1–19.
93. Reiffers J, Caillot C, Dazey B, et al. Abrogation of postmyeloablative chemotherapy neutropenia by ex vivo expanded autologous CD34 positive cells. *Lancet* 354:1092–1093, 1999.
94. Boitard C. *B Cells and Autoantibody Production in Autoimmune Diseases*. Heidelberg, Germany: Springer-Landes, 1996.
95. Krance R, Brenner M. BMT beats autoimmune disease. *Nat Med* 4:153–155, 1998.
96. Guillaume T, Rubinstein DB, Syman M. Immune reconstitution and immunotherapy after autologous hematopoietic stem cell transplantation [review]. *Blood* 92:1471–1490, 1998.
97. Mackall CL. T-cell immunodeficiency following cytotoxic antineoplastic therapy: a review. *Stem Cells* 18:10–18, 2000.

98. Durez P, Toungouz M, Schandence L. Remission and immune reconstitution after T-cell depleted stem cell transplantation for rheumatoid arthritis [letter]. *Lancet* 352:881, 1998.
99. Bomberger C, Singh Jairam M, Rodey G, et al. Lymphoid reconstitution after autologous PBSC transplantation with FACS-sorted CD34<sup>+</sup> hematopoietic progenitors. *Blood* 91:2588–2600, 1998.
100. Heitger A, Neu N, Kern H, et al. Essential role of the thymus to reconstitute naive (CD4RA<sup>+</sup>) T-helper cells after human allogeneic bone marrow transplantation. *Blood* 90:850–857, 1997.
101. Douek DC, Vescio RA, Betts MR, et al. Assessment of thymic output in adults after haematopoietic stem cell transplantation and prediction of T-cell reconstitution. *Lancet* 355:1875–1881, 2000.
102. Hakim FT, Capada R, Kaimei S, et al. Constraints on CD<sup>+</sup> recovery postchemotherapy in adults: thymicin sufficiency and apoptotic decline of expanded peripheral CD<sup>+</sup> cells. *Blood* 90:3789–3798, 1997.
103. Mackall CL, Stein D, Fleisher TA, et al. Prolonged CD4 depletion after sequential autologous peripheral blood progenitor cell infusions in children and young adults. *Blood* 96:754–762, 2000.
104. Frassoni F, Labopin M, Gluckman E, et al. Results of allogeneic bone marrow transplantation for acute leukaemia have improved over time in Europe. *Bone Marrow Transplant* 17:13–18, 1996.
105. Slavin S, Nagler A, Naparstek E, et al. Nonmyeloablative stem cell transplantation and cell therapy as an alternative to conventional bone marrow transplantation with lethal cytoreduction for the treatment of malignant and nonmalignant hematologic disease. *Blood* 91:756–763, 1998.
106. Khouri IF, Keating M, Korbling M, et al. Transplant-lite: induction of graft-versus-malignancy using fludarabine-based nonablative chemotherapy and allogeneic blood progenitor-cell transplantation as treatment for lymphoid malignancies. *J Clin Oncol* 16:2817–2824, 1998.
107. Storb R. Nonmyeloablative preparative regimens: experimental data and clinical practice. *Am Soc Clin Oncol Educ Book* 1999, p. 241–249.
108. Marmont AM, van Bekkum DW. Stem cell transplantation for severe autoimmune diseases: new proposals but still unanswered questions. *Bone Marrow Transplant* 16:407–408, 1995.
109. Gao L, Bellantuono I, Elsasser E, et al. Selective elimination of leukemic CD34<sup>+</sup> progenitor cells by cytotoxic T lymphocytes specific for WTI. *Blood* 95:2198–2203, 2000.
110. Deapen DM, Escalante A, Weintraub L, et al. A revised estimate of twin concordance in systemic lupus erythematosus. *Arthritis Rheum* 35:311–318, 1992.
111. Arnett FC. The genetics of human lupus. In: Wallace DJ, Hahn BH, eds. *Dubois' Lupus Erythematosus*. Baltimore, MD: Williams & Wilkins, 1997, p.77–117.
112. Reichlin M. Systemic lupus erythematosus. In: Rose NR, Mackay IR, eds. *The Autoimmune Diseases*. San Diego, CA: Academic Press, 1998, p. 283–298.
113. Waldmann H, Cobbold S. Reprogramming the immune system. In: Lydyard BM, Brostoff J, eds. *Autoimmune Disease: Aethopathogenesis, Diagnosis and Treatment*. Oxford, UK: Blackwell, 1994, p. 164–165.

114. Burt RK, Brenner M, Burns W, et al. Gene-marked autologous hematopoietic stem cell transplantation of autoimmune disease. *J Clin Immunol* 20:1–9, 2000.
115. Shoenfeld Y. Eppur si muove (Galileo Galilei 1564–1642): the idiotypic dysregulation of autoantibodies as part of the etiology of SLE. *Lupus* 9:481–483, 2000.
116. Curtis RE, Rowlings PA, Deeg HJ, et al. Solid cancers after bone marrow transplantation. *N Engl J Med* 336:897–904, 1997.
117. Dorrington DL, Vase JM, Anderson R, et al. Incidence and characterization of secondary myelodysplastic syndrome and acute myelogenous leukemia following high-dose radiochemotherapy and autologous stem cell transplantation for lymphoid malignancies. *J Clin Oncol* 12:2527–2534, 1994.
118. Wallace C, Sherry DD. Trial of intravenous pulse cyclophosphamide and methylprednisolone in the treatment of severe systemic-onset juvenile rheumatoid arthritis. *Arthritis Rheum* 40:1852–1855, 1997.
119. PRISM Study Group. Randomised double-blind placebo-controlled study of interferon beta-1a in relapsing/remitting multiple sclerosis. *Lancet* 52:1491–1497, 1998.



# **Hematopoietic Stem Cell Transplantation in the Treatment of Severe Autoimmune Disease**

***Alan Tyndall, on behalf of the European Group for Blood and Marrow Transplantation/European League Against Rheumatism and International Stem Cell Database***

*University of Basel, Basel, Switzerland*

Currently, data on 290 registrations (285 autologous and 5 allogeneic) hematopoietic stem cell transplantations (HSCTs) are available. Of the autologous HSCTs, 283 were mobilized (2 double transplants), and 275 were transplanted. Data are from 64 transplant centers in 22 countries, median age 36 years (range, 2–65 years), and 68% female. Interval diagnosis to HSCT was 6 years (range, 1–28 years) with a median follow-up of 12 months (range, 1–60 months).

Most common autoimmune diseases (ADs) transplanted were multiple sclerosis (MS) (90 patients) and systemic sclerosis (SSc), also called scleroderma (57 cases). This probably reflects a lack of viable treatment alternatives in these progressive diseases. Other target diseases were rheumatoid arthritis (RA) (42), juvenile idiopathic arthritis (JIA) (formerly called juvenile rheumatoid arthritis) (33), systemic lupus erythematosus (SLE) (22), dermatomyositis/polymyositis (5), mixed connective tissue disease (3), cryoglobulinemia (3), Wegener's granulomatosis (3), idiopathic thrombocytopenic purpura (7), autoimmune hemolytic anemia (2), pure red cell aplasia (4), thrombotic microangiopathy (2), and others including myasthenia gravis, polyneuropathy, Behçet's disease, relapsing polychondritis, Evans' syndrome, and polyarteritis nodosa.

The stem cell source was peripheral blood in 246 patients and bone marrow in 38, mostly in children. Mobilization was with cyclophosphamide (CY) and granulocyte colony-stimulating factor (G-CSF) in the majority of cases (153), G-CSF alone in 64, and CY and GM-CSF in 9.

Four basic conditioning regimens were employed: BEAM (BCNU, etoposide, cytosine arabinoside, and melphalan) ± antithymocyte globulin (ATG) (60), mostly in MS, CY 200 mg/kg, especially in SSc (71), CY and antibodies (62), CY and radiation ± ATG, and busulfan/CY ± ATG. Other regimens were used in 18.

In 141 cases, CD34<sup>+</sup> selection was used, in 27 CD34<sup>+</sup> selection plus T- and B-cell purging, T-cell purging only in 18, and in 77, a nonselected graft was used. There is no clear evidence that T-cell depletion leads to a significantly better result, although a preliminary analysis of the whole data set shows a trend toward a lower rate of relapse. Given the different immunopathologies of the different ADs,

subgroup analysis most likely will be needed. For example, in the randomized study from Australia on RA with unselected vs. CD34<sup>+</sup>-selected grafts, no benefit was seen—indeed, a suggestion that more relapses occurred in the selected patients was noted. In general, patients with heavily T-cell-depleted grafts had more infectious complications, and some showed prolonged CD4-penia out to 4 years (SSc patients).

Overall, a 9% transplant-related mortality (TRM) was observed with marked differences in AD subgroups. Mortality was more common in SSc (6 of 57 cases) and JIA (5 of 33) and least so in RA (1 of 42). This finding was thought to be related in part to a generally poorer general medical condition in the higher TRM groups, with some suggestion that the more ablative regimens were more toxic. A better outcome, including a lower rate of relapse, was not clearly evident with the more ablative regimens. At least 3 deaths were attributed to mobilization.

Around two thirds of cases responded or stabilized following HSCT, with some relapses seen especially in RA (~50%). However, in many of these relapses, disease control was further achieved with conventional medications that were ineffective pretransplant. In SSc, 69% of patients achieved an improvement in the skin score of 25% or more, with a stabilization of lung function in most.

Clearly, more precise and standardized protocols and outcome measurements are required for a more accurate assessment, and this is currently proceeding. Internationally agreed outcome measurement for the major ADs are available through the intense and combined effort of the International Blood and Marrow Transplant Registry, European Group for Blood and Marrow Transplantation (EBMT), European League Against Rheumatism (EULAR), and other specialty groups.

Prospective, randomized controlled trials are needed, and such a protocol is available for SSc. The patients will be selected according to clear inclusion and exclusion criteria to avoid undue toxicity (mean pulmonary artery pressure <50 mmHg, pulmonary carbon monoxide diffusion capacity >50% predicted, left ventricular ejection fraction >50 normal, etc), and HSCT will be compared with monthly CY 750 mg intravenously as often as standard but not proven therapy. HSCT will consist of mobilization with CY 2×2 g/m<sup>2</sup>, conditioning with CY 200 mg/kg plus ATG, total 7.5 mg/kg, and CD34<sup>+</sup> selection. This will be a multi-center, internationally trial. Similar studies are being planned for MS, based on the current experience, and SLE and vasculitis protocols are in the discussion phase.

RA studies have been influenced by the advent of anti-tumor necrosis factor- $\alpha$  (anti-TNF- $\alpha$ ) treatment (failed therapy is an inclusion criteria), but already some such patients have been transplanted (~15%–20% of RA patients do not respond to anti-TNF treatment).

Other ADs such as Crohn's disease and ulcerative colitis are under discussion, and the combined experience will be presented and discussed in plenum during the upcoming meeting in Basel (October 5–7, 2000), with a view to finding consensus

on the analysis. So far, no outstanding differences have been seen not previously observed with immune reconstitution following autologous HSCT for other diseases. CD8 and CD8 and CD45RO (memory T cells) reappear before CD45RA (naive) cells, probably reflecting peripheral expansion of residual T cells post-transplant. So far, the phenotypes of T cells have not predicted relapse or outcome, apart from infection with prolonged CD4-penia.

It is hoped that such potentially toxic and expensive treatment will not be needed in the future if more focused and effective options become available, especially with biologics. In the meantime, for life- or organ-threatening ADs, HSCT appears to offer another alternative but should be in the context of prospective, randomized trials rather than small anecdotal series and case reports.

# **An Update of the Results of Autologous Stem Cell Transplantation in Treatment of Multiple Sclerosis**

***Athanasios Fassas, for the EBMT Autoimmune Disease Working Party***

*Department of Hematology, The George Papanicolaou Hospital,  
Thessaloniki, Greece*

## **ABSTRACT**

From April 1995 to December 1997, we treated 24 patients with chronic progressive multiple sclerosis (pMS) using high-dose immuno-/myelosuppressive chemotherapy (BEAM [BCNU, etoposide, cytosine arabinoside, and melphalan]) followed by infusion of cyclophosphamide/granulocyte colony-stimulating factor (G-CSF)-mobilized autologous peripheral blood stem cells (autologous stem cell transplantation [autoSCT]) and antithymocyte globulin (ATG). Here we update previously reported early results, as the median follow-up time of the patients has exceeded 40 months (range, 27–60 months). Treatment-related mortality, which is due to early infection, remains 4%. No serious late complications have developed. Compared with baseline status, the progression-free survival (PFS) probability is 89% for secondary pMS, an impressive result that no other therapy, including interferon (IFN)- $\beta$ , has ever yielded. Results are not as good and are questionable in primary pMS. Moreover, neurological events following SCT have occurred in nearly all patients, indicating that MS cannot be cured by autoSCT but can be brought to a lower activity level. Similar results are accumulating in the European Group for Blood and Marrow Transplantation (EBMT) Autoimmune Diseases Working Party Registry database, which contains 80 transplants reported from 21 centers worldwide. A recent comprehensive analysis performed in evaluable cases with pMS ( $n = 85$ ) having a median expanded disability status scale (EDSS) score of 6.5 (range, 4.5–8.5) has yielded a PFS rate of 72% at 18 months, 78% for nonprimary pMS cases. Total mortality rate was 8%, with 6% of deaths directly related to therapy. A degree of neurotoxicity was observed during stem cell mobilization (4% of cases) and also after stem cell infusion (25% of cases). This was ascribed to fever and infections during the cytopenic period. The BEAM and BUCY-2 (busulfan and cyclophosphamide) regimens were usually used for conditioning, and most patients also received ATG; a few underwent total body irradiation. Some form of ex vivo T-cell depletion of the graft was performed in 59% of the cases. Lymphopenia was profound and prolonged but was not

associated with serious late infections, except for in one patient who developed pneumococcal sepsis and died 17 months after SCT. Despite a somewhat elevated mortality risk, which could possibly be lowered, these results show that autoSCT is feasible as treatment for MS and may delay progression of the disease through the associated intense immunosuppression. They also justify further trials comparing this kind of therapy with the best available drug—IFN- $\beta$ —or with high-dose regimens of acceptable toxicity.

## INTRODUCTION

High-dose myelo-/immunosuppressive therapy followed by autoSCT has been recently introduced in the treatment of severe active autoimmune disease (AD) refractory to conventional treatment, mainly systemic sclerosis, rheumatoid arthritis, juvenile chronic arthritis, lupus, and multiple sclerosis.<sup>1,2</sup> The rationale and experimental basis for the use of this novel potentially dangerous anticancer treatment against nonmalignant occasionally life-threatening disorders has been extensively discussed.<sup>1,3</sup> The number of patients undergoing such a treatment for AD is steadily increasing worldwide, and a special registry for these cases has been created by EBMT in cooperation with the European League Against Rheumatism (EULAR).<sup>4</sup> In this article, we update previously published information about the first group of patients who received high-dose chemotherapy and autoSCT as treatment for chronic progressive MS in a single institution.<sup>5-7</sup> In addition, we present results of a preliminary analysis of data from the EBMT/EULAR registry regarding MS patients who were treated with autoSCT and most recently reported to the registry.

## THE THESSALONIKI STUDY

The first MS study was initiated in April 1995 and closed in December 1997. The patients' characteristics and the methods used have been described.<sup>5,6</sup> In short, 24 patients aged 22 to 54 years (median, 40 years) were treated; all had chronic progressive disease and most had secondary pMS (ie, progressive disease following the relapsing/remitting phase; 13 cases). Chronic pMS is notorious for its refractoriness to treatment, and practically all conventional immunosuppressive therapies, although promising initially, did eventually prove inactive in delaying progression of disability. The patients were also severely disabled, with a median score of 6.5 (range, 4.5–8) on the EDSS. Moreover, all had evidence of active disease either clinically—ie, they had progressed by 1 point on the EDSS in the year preceding enrollment—or in magnetic resonance imaging (MRI) scans showing new, enlarging, or gadolinium-enhancing lesions. All patients received the BEAM chemotherapy for conditioning—which is used in autoSCT for lymphomas,

as described previously—along with ATG for *in vivo* T-cell depletion.<sup>5</sup> For rescue, blood stem cells were used, mobilized by cyclophosphamide (CY) 4 g/m<sup>2</sup> and G-/granulocyte-macrophage (GM)-CSF 5 or 10 µg/kg. *Ex vivo* 3-log purging of T cells was performed in 9 cases (38%) using the CD34<sup>+</sup> cell selection method. There were no mobilization or graft failures. Early toxicity included infections, with 1 death (4%), and a degree of neurological decompensation in 10 cases (42%); however, this condition was transient and did not seem to influence disease progression. Currently, at a median follow-up period of 40 months (range, 27–60 months) the confirmed PFS rate is 75% for all patients and 89% for patients with secondary pMS. No serious late complications have developed apart from one case of thyroiditis.<sup>7</sup>

This study has shown that SCT is feasible in treating AD, although it is potentially dangerous. The results of efficacy are surprisingly good, and no other treatment, including IFN-β, has ever been proven so effective in respect to PFS. The neurology community, however, has been very skeptical. Criticisms have centered on the toxicity, cost, and unblinded assessment of neurological status.<sup>8</sup> Nevertheless, two things seem to be clear: confirmatory studies are warranted, and future trials should also enroll patients at earlier stages of disease—that is, before the development of irreversible axonal damage in the central nervous system.

### THE EBMT STUDY

The analysis was made in a total of 85 patients (including the Thessaloniki patients) from 20 centers in Europe and the United States reporting their data to the EBMT/EULAR registry in Basel, Switzerland (Table 1). Patients' median age was 39 years (range, 20–58 years), and the median EDSS score was 6.5 (range, 4.5–8.5). The majority (95%) had progressive disease—ie, secondary pMS (55%), relapsing/progressive MS (14%), primary pMS (22%), and progressive/relapsing MS (5%). Three patients (5%) were still in the relapsing/remitting phase. Active disease was detected in 34% of patients by MRI.

Seventy-nine of 85 patients received grafts of blood stem cells mobilized with CY plus G-/GM-CSF or G-CSF alone. In 50 cases (59%), the grafts (including the marrow ones) were purged *ex vivo*, mainly with the CD34<sup>+</sup> cell selection method. There were 2 failures of mobilization, which necessitated a second attempt with G-CSF alone. In 3 cases, there was evidence of disease exacerbation (4%), which was ascribed to G-CSF. Interestingly, CY 4 g/m<sup>2</sup> for mobilization was beneficial for some patients: 4 improved clinically by 1 or more EDSS points, and a number of MRI scans showing active disease at entry improved significantly.

The BEAM regimen, with or without ATG or dexamethasone (dxa-BEAM), was mostly used for conditioning (65%). Busulfan in combination with ATG and/or high-dose CY was employed in 18% of cases, but TBI 1000 cGy with CY

**Table 1.** EBMT Study on Multiple Sclerosis: Participating Centers

---

Total centers: 20
Total patients: 85
Barcelona, Spain: Hospital Clinic
Barcelona, Spain: Vall d'Hebron
Basel, Switzerland: Kantonspital Basel
Besançon, France: Jean Minjot
Cagliari, Italy: Binaghi Hospitals/Multiple Sclerosis Center
Florence, Italy: Careggi Hospital
Genoa, Italy: S. Martino Hospital, Genoa University/Department of Neurology
Haifa: Rambam Medical Center
Hannover, Germany: Medical School of Hannover/Department of Hematology-Oncology
Leuven, Belgium: Gasthuisberg University Hospital
Los Angeles, California: City of Hope Medical Center
Palermo, Italy: La Maddalena Cancer Hospital
Paris, France: St. Antoine Hospital
Pisa, Italy: Azienda Ospedali/Division of Hematology
Poznan, Poland: Marcinkowski University/Department of Hematology
Prague, Czech Republic: Charles University/Department of Clinical Hematology
Rome, Italy: Tor Vergata University/Department of Hematology
Rotterdam, The Netherlands: University Hospital Rotterdam/Department of Hematology
Thessaloniki, Greece: George Papanicolaou Hospital
Trieste, Italy: Children's Institute

---

and ATG was used in only 5 cases (6%). It is interesting that the majority of patients (78%) received ATG as part of the conditioning regimen. Four patients died in the early posttransplant period of treatment-related toxicities, namely infection and cardiac failure (Table 2). Another patient died later, 17 months posttransplant, of sepsis due to prolonged lymphopenia; 2 patients died of disease progression, probably related to SCT. In all, mortality was 8% (7 of 85), 6% (5 of 85) directly ascribed to SCT. However, 18 patients (21%) were improved after the procedure by 1 or more EDSS points. Currently, at a median follow-up time of 16 months (range, 2 months to 5 years), confirmed progression of disability has been detected in only 10 patients, whereas 59 patients (70%) are in stable ( $n = 47$ ) or improved ( $n = 12$ ) neurologic condition. In 9 cases, the last neurologic assessment disclosed a degree of progression that needed confirmation. The probability of confirmed PFS at 3 years is 72% (calculating dead patients as progressed) and is slightly higher (78%) for all cases except those of primary pMS, which is notoriously refractory to treatment and possibly not an autoimmune disease (Figure 1). In addition, the results of the Thessaloniki study did not differ statistically from those of other centers. Because, according to protocols in certain centers, the results

**Table 2.** EBMT Study on Multiple Sclerosis: Transplant Toxicity\*

Neurotoxicity	21/83 (25%)
<ul style="list-style-type: none"> <li>• Paresis, visual, confusion, vertigo, fatigue, headache, epilepsy, ataxia, aphasia</li> <li>• MS progression in 5 cases (6%); transplant-related?</li> </ul>	
Medical, early, grade III–IV	35/73 (48%)
<ul style="list-style-type: none"> <li>• Infection (48%), sepsis and death (1), cardiac failure and death (1), viral infection and death (1), aspergillosis (1), allergy, bleeding, liver toxicity and VOD, CMV-reactivation, herpes, TTP</li> </ul>	
Late complications: zoster 2, thyroiditis 1, CMV?-pneumonitis 1, sepsis and death 1 (>17 mo)	
Mortality	8%
<ul style="list-style-type: none"> <li>• Toxic (6%), disease (2%)</li> </ul>	

\**CMV, cytomegalovirus; EBMT, European Group for Blood and Marrow Transplantation; MS, multiple sclerosis; TTP, thrombotic microangiopathy; VOD, veno-occlusive disease.*

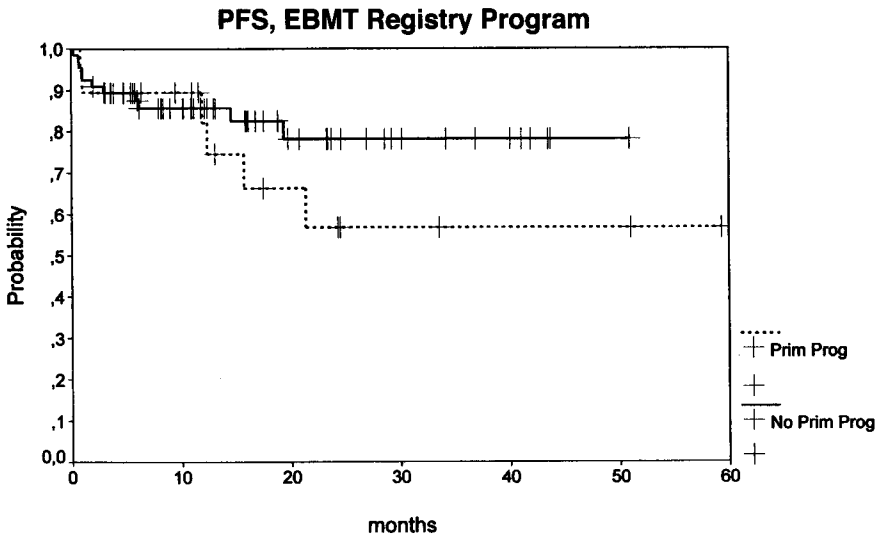
of MRI scanning could not be known to clinicians so as to prevent subjective influences at the neurological evaluations, the MRI results were available in only 60 cases (71%), of which 5 showed active disease posttransplant. Pretransplant scans showing active disease in 23 patients disclosed no activity posttransplant, and of 37 scans that were inactive before transplant, 5 turned active after transplant.

## DISCUSSION AND CONCLUSIONS

It may be too early to judge the efficacy of SCT in MS, a chronic disease with a rather unpredictable course. Traditionally, a follow-up period of 3 years is needed; therefore, we still have to wait before reaching conclusions. At the present time, it seems that the results do not differ among centers.<sup>7,9,10</sup> There are certain mortality and morbidity risks even at mobilization<sup>11</sup> that may compromise success, but with proper selection of patients—and given the possibility of a high PFS rate—autoSCT might prove the best available therapy for rapidly evolving MS. It certainly cannot cure the disease, but it seems to delay progression with its intense immunosuppressive effect. It appears better than no therapy<sup>12</sup> or any other immunosuppressive treatment, including IFN- $\beta$ .<sup>13</sup>

Currently, only phase 1–2 trials are being conducted, but, even if they all confirm the efficacy of SCT in MS, their results will remain doubtful, no matter how high the PFS rate might be 3 years after transplantation. MRI findings, being objective, will be accepted more easily. However, the only proper way to demonstrate the efficacy of SCT will be to perform a multicenter, randomized trial comparing autoSCT with the best available MS treatment, most probably IFN- $\beta$ .





**Figure 1.** Progression-free survival (PFS) by disease type for 85 patients with multiple sclerosis (MS) undergoing high-dose immunosuppressive therapy and autologous stem cell transplantation; primary progressive MS (Prim Prog;  $n = 19$ ) vs. all other types (No Prim Prog), ie, secondary progressive ( $n = 46$ ), relapsing/progressive ( $n = 12$ ), relapsing/remitting ( $n = 3$ ), and progressive/relapsing ( $n = 4$ ).

The sooner this is conducted, the better the chance of offering patients an active therapy or of sparing them a toxic and costly procedure.

## REFERENCES

1. Marmont AM. New horizons in the treatment of autoimmune diseases. *Annu Rev Med* 51:115–134, 2000.
2. Snowden JA, Brooks PM. Hematopoietic stem cell transplantation in rheumatic diseases. *Curr Opin Rheumatol* 11:167–172, 1999.
3. Van Bekkum DW. New opportunities for the treatment of severe autoimmune diseases: bone marrow transplantation. *Clin Immunol Immunopathol* 89:1–10, 1998.
4. Tyndall A, Fassas A, Passweg J, et al. Autologous haematopoietic stem cell transplants for autoimmune disease: feasibility and transplant-related mortality. *Bone Marrow Transplant* 24:729–734, 1999.
5. Fassas A, Anagnostopoulos A, Kazis A, et al. Peripheral blood stem cell transplantation in the treatment of progressive multiple sclerosis. *Bone Marrow Transplant* 20:631–638, 1997.
6. Fassas A, Anagnostopoulos A, Kazis A, et al. Autologous blood stem cell therapy for progressive multiple sclerosis. In Dicke KA, Keating A, eds. *Autologous Blood and Marrow*

*Transplantation: Proceedings of the Ninth International Symposium, Arlington, Texas.* Charlottesville, VA: Carden Jennings, 1999, p. 452–463.

7. Fassas A, Anagnostopoulos A, Kazis A, et al. Autologous stem cell transplantation in progressive multiple sclerosis: an interim analysis of efficacy. *J Clin Immunol* 20:24–30, 2000.
8. Noseworthy JH. Multiple Sclerosis. In: Bradley WG, Gibbs SR, eds. *The Yearbook of Neurology and Neurosurgery*. St. Louis, MO: Mosby, 1999, p. 203–205.
9. Burt RK, Traynor AE, Pope R, et al. Treatment of autoimmune disease by intense immunosuppressive conditioning and autologous hematopoietic stem cell transplantation. *Blood* 92:3505–3514, 1998.
10. Kozak T, Havroda E, Pit'ha J, et al. High-dose immunosuppressive therapy with PBPC support in the treatment of poor-risk multiple sclerosis. *Bone Marrow Transplant* 25: 525–531, 2000.
11. Openshaw H, Stuve O, Antel JP, et al. Multiple sclerosis flares associated with recombinant granulocyte colony-stimulating factor. *Neurology* 54:2150–2153, 2000.
12. Weinshenker G, Issa M, Baskerville J. Meta-analysis of the placebo-treated groups in clinical trials of progressive MS. *Neurology* 46:1613–1619, 1996.
13. Placebo-controlled multicentre randomised trial of interferon  $\beta$ -1b in treatment of secondary progressive multiple sclerosis. European Study Group on Interferon  $\beta$ -1b in Treatment of Secondary Progressive MS. *Lancet* 352:1491–1497, 1998.

# **High-Dose Immunosuppressive Therapy as Treatment for Severe Systemic Sclerosis**

**Peter A. McSweeney, Daniel E. Furst, Richard A. Nash,  
Leona Holmberg, Federico Viganego, Kevin McDonough,  
Leslie Crofford, Roger Dansey, Maureen Mayes, Jan Storek,  
Gretchen Agee, Kathy Prather, Katherine Ryan, Keith M. Sullivan,  
for the National Collaborative Study for SCT in Autoimmune Diseases**

*University of Colorado (P.A.M., G.E.), Virginia Mason Medical Center (D.E.F.),  
Fred Hutchinson Cancer Research Center (R.A.N., L.H., F.V., K.P., K.R.),  
University of Michigan (K.M., L.C.), Wayne State University (R.D., M.M.),  
Duke University (J.S., K.M.S.)*

## **INTRODUCTION**

Severe systemic sclerosis (SSc) is a rare multisystem disease characterized by skin thickening and hardening together with varying degrees of internal organ involvement affecting lungs, kidneys, heart, and gastrointestinal tract. Internal involvement has a poor prognosis, with deaths primarily due to pulmonary failure and cardiac events. Although the exact pathogenesis remains unclear, it is thought to be primarily immunologic in nature, with secondary involvement of tissue fibroblasts, and small-vessel damage leading to fibrotic changes in a variety of organs. Evidence to support the etiology of autoimmunity includes the presence of autoantibodies such as Scl-70; overlap syndromes with diseases such as systemic lupus erythematosus (SLE); finding of T-cell populations in skin lesions; detection of oligoclonal lymphocyte populations in the blood and bronchoalveolar lavage fluid; and similarities to chronic graft-vs.-host disease. Conventional-dose immunosuppression and some other agents have been tried without clear evidence of success in SSc.

High-dose immunosuppressive therapy (HDIT) followed by autologous stem cell transplantation has recently been proposed as a potential treatment for severe autoimmune diseases.<sup>1,2</sup> Impetus for this approach came from animal studies and anecdotal clinical observations.<sup>3-7</sup> Initial results have been reported for multiple sclerosis<sup>8,9</sup> and a number of rheumatologic diseases including systemic sclerosis, rheumatoid arthritis, SLE, and others.<sup>10</sup> The use of high-dose therapy in these studies was modeled on conditioning regimens that were developed and extensively tested in the setting of allogeneic and autologous bone marrow trans-

plants for malignancy and aplastic anemia. Whereas the toxicity profiles have been defined in patients with cancer with relatively good end organ function, there were relatively little data to indicate what might be anticipated with the use of high-dose regimens in patients with preexisting organ damage from an underlying autoimmune disease.

## METHODS

This study was designed to investigate safety and potential efficacy of HDIT for severe systemic sclerosis. Specifically, we planned to evaluate the toxicity and potential efficacy of a regimen incorporating total body irradiation 800 cGy, cyclophosphamide, and horse antithymocyte globulin (ATG). The basis for our approach<sup>11</sup> and for patient selection<sup>12</sup> have been reported previously. Eligibility required disease duration of <3 years, a modified Rodnan skin score (RSS) of >15, and evidence of internal organ disease affecting lungs, kidney, or heart (group A) or SSc of longer duration but with clear evidence of progressive lung disease (group B). The primary end points were regimen-related toxicity (by day 28, according to the Bearman scale) and engraftment. Secondary end points were disease response and immune recovery. Eighteen patients underwent treatment

### **STEM CELL COLLECTION AND CD34 SELECTION**

G-CSF 16 ug/kg/d subcutaneously.

CD34 selection of PBSC with Isolex 300i.

### **CONDITIONING REGIMEN**

<u>DAY</u>	<u>TREATMENT</u>
-5	TBI 2.0 Gy x 2 + ATG*
-4	TBI 2.0 Gy x 2
-3	Cyclophosphamide 60 mg/kg + ATG*
-2	Cyclophosphamide 60 mg/kg
-1	ATG *
0	CD34 selected PBSC infusion
+1	ATG *
+3	ATG *
+5	ATG *

\* ATG = 15 mg/kg

### **POST TRANSPLANT GROWTH FACTOR**

G-CSF from day 0 to ANC > 500 for 3 days

**Figure 1.** Treatment schema for high-dose immunosuppressive therapy. ANC, absolute neutrophil count; ATG, antithymocyte globulin; G-CSF, granulocyte colony-stimulating factor; PBSC, peripheral blood stem cell; TBI, total body irradiation.

between January 1997 and February 2000 according to the protocol shown in Figure 1. Patients underwent peripheral blood stem cell (PBSC) mobilization as outpatients, with granulocyte colony-stimulating factor (G-CSF) given at 16  $\mu\text{g}/\text{kg}$  per day subcutaneously. Leukaphereses were performed on day 4 of G-CSF, with a plan to collect PBSCs containing  $>3.0 \times 10^6$  CD34<sup>+</sup> cells/kg. Cells were CD34-selected using an Isolex 300i (Nexell, Irvine, CA). After HDIT and transplant, G-CSF 5  $\mu\text{g}/\text{kg}$  per day was given until engraftment. Infection prophylaxis included trimethoprim/sulfamethoxazole (Bactrim) for pneumocystis and fluconazole for fungal infections, and patients were monitored for cytomegalovirus (CMV) reactivation with antigenemia testing or polymerase chain reaction. Reactivation of CMV was treated with ganciclovir.

## RESULTS

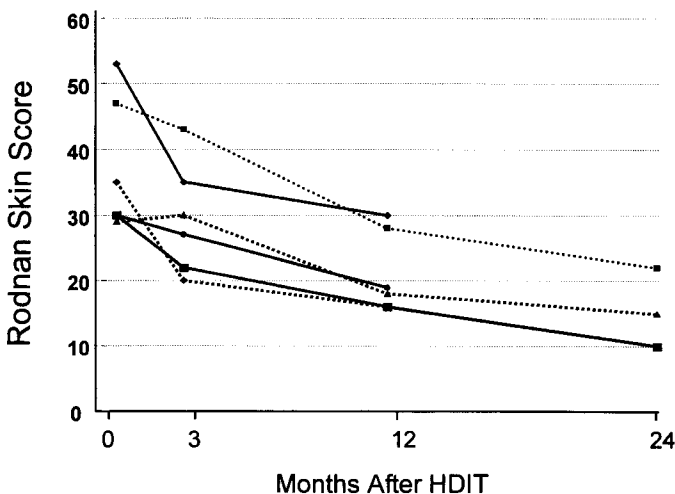
The median age for the 18 patients was 40.5 years (range, 23–61 years). Sixteen of the patients were women. Sixteen patients belonged to group A and 2 to group B, as defined previously. The median baseline RSS was 30 (range, 3–50). Seventeen of 18 patients were treated because of underlying lung disease, and 1 patient, because of kidney disease. Median pulmonary carbon monoxide diffusion capacity (DLCO) at transplant was 56 (range, 38–76). G-CSF was tolerated well, without major disease activation. The median number of aphereses to obtain the target CD34<sup>+</sup> cell dose together with an unselected backup containing  $>3 \times 10^6$  CD34<sup>+</sup> cells/kg was 3 (range, 2–7). The median number of CD34<sup>+</sup> cells infused was  $4.2 \times 10^6$ , with a median purity of 91.5% (range, 55% to 96%). Both neutrophil and platelet engraftment were prompt with this protocol. The absolute neutrophil count was  $<500/\mu\text{L}$  for a median of 7 days (range, 0–10 days). There were no life-threatening bacterial or fungal infections. CMV reactivation was detected in 3 of 10 CMV-seropositive patients and was treated effectively with ganciclovir in each instance.

Conditioning therapy was well tolerated by most patients, with minimal mucositis. One patient developed onset of pulmonary failure due to interstitial pneumonitis ~2 weeks after transplant. A second patient developed a similar syndrome at 2 months after transplant. Both patients had progressive pulmonary failure requiring mechanical ventilation and died despite high-dose steroid therapy. These deaths were attributed to regimen-related toxicity, since there was no clear evidence of disease progression after HDIT. The protocol was then modified to include lung shielding to allow a total lung dose of 200 cGy. This has been well tolerated from a pulmonary standpoint, without obvious regimen-related pulmonary damage in subsequent patients. Another patient presented with a cardio-respiratory arrest ~2 months after transplant. This was followed by development over 2 weeks of rapidly increasing lymphocytosis and rapidly enlarging liver,

spleen, and lymph nodes. A diagnosis of Epstein-Barr virus–induced lymphoproliferative disorder was made on biopsy. The patient died of rapidly progressive lymphoma. Of note, this patient had previously had a reaction to horse ATG and received rabbit ATG as a substitute, possibly leading to more profound immunosuppression and predisposing to the development of lymphoma.

Median survival of the 15 survivors was 6 months (range, 1–36 months). All had evidence of disease responses early after transplant as determined by the Rodnan skin score and/or health assessment questionnaire (HAQ) analyses. Clear evidence of disease reactivation requiring therapy occurred in 1 patient at ~1 year after HDIT. Disease reactivation responded well to treatment with tacrolimus, whereas the disease had not responded to cyclosporine given before HDIT.

Among 6 patients followed for >1 year with a median follow up of 711 days (range, 431 to 1040 days), the RSS had improved from a median of 32.5 pretransplant to 18.5 at 1 year ( $P=.03$ ) (Figure 2). In 3 patients with >2 years' follow up, the RSS improved from 28, 18, and 16 at 1 year to 22, 15, and 10, respectively, at 2 years after transplant. Pulmonary function tests showed a median DLCO of 58% at baseline and 53% at 1 year after HDIT. Computed tomography scans of lungs showed stable findings in most patients after HDIT, and improvements in alveolitis were observed in some patients. Overall, renal function remained stable after transplant. Quality-of-life assessments were performed using a modified scleroderma HAQ, which has a 3-point scale, normal being 0. HAQ scores were 2.0 (range, 0.25–2.25) at baseline, 0.7 (range, 0.25–1.5) at 3 months, and 0.2 (range, 0–0.75) at 1 year ( $P=.06$ ).



**Figure 2.** Rodnan skin scores (RSS) after HDIT.

## SUMMARY

Although follow-up is short and only a small number of patients have been treated, preliminary data suggest that HDIT produces disease responses in patients with severe SSc. These may continue to occur for 2 years after HDIT. Responses have been documented mainly in skin disease and appear primarily responsible for the improved quality of life after HDIT as determined by HAQ scores. To date, internal organ functions overall have remained roughly stable after HDIT.

Multisystem advanced disease in SSc appears to predispose to substantial risk of toxicity after high-dose therapy. Similar observations with respect to responses and higher-than-expected toxicity with regimens incorporating mainly high-dose cyclophosphamide have been reported by the European Transplant Registry.<sup>10</sup> Further modifications of treatment protocols and selection of better-risk candidates may improve outcomes. The identification of useful prognostic factors that would allow treatment at an earlier stage, when organ dysfunction and disability are less severe, may lead to better outcomes. Carefully designed phase 3 studies will be needed to determine whether HDIT is an effective therapy for SSc.

## REFERENCES

1. Sullivan KM, Furst DE. The evolving role of blood and marrow transplantation for the treatment of autoimmune diseases. *J Rheumatol* 24:1–4, 1997.
2. Tyndall A, Gratwohl A. Blood and marrow stem cell transplants in autoimmune diseases: a consensus report written on behalf of the European League Against Rheumatism (EULAR) and the European Group for Blood and Marrow Transplantation (EBMT). *Bone Marrow Transplant* 19:643–645, 1997.
3. Ikehara S, Good RA, Nakamura T, et al. Rationale for bone marrow transplantation in the treatment of autoimmune diseases. *Proc Natl Acad Sci U S A* 82:2483–2487, 1985.
4. van Bekkum DW, Bohre EP, Houben PF, Knaan-Shanzer S. Regression of adjuvant-induced arthritis in rats following bone marrow transplantation. *Proc Natl Acad Sci U S A* 86:10090–10094, 1989.
5. van Gelder M, Kinwel-Bohre EP, van Bekkum DW. Treatment of experimental allergic encephalomyelitis in rats with total body irradiation and syngeneic BMT. *Bone Marrow Transplant* 11:233–241, 1993.
6. Nelson JL, Torrez R, Louie FM, Choe OS, Storb R, Sullivan KM. Pre-existing autoimmune disease in patients with long-term survival after allogeneic bone marrow transplantation. *J Rheumatol* 24:23–29, 1997.
7. Snowden JA, Kearney P, Kearney A, et al. Long-term outcome of autoimmune disease following allogeneic bone marrow transplantation. *Arthr Rheum* 41:453–459, 1998.
8. Fassas A, Anagnostopoulos A, Kazis A, et al. Peripheral blood stem cell transplantation in the treatment of progressive multiple sclerosis: first results of a pilot study. *Bone Marrow Transplant* 20:631–638, 1997.

9. Fassas A, Anagnostopoulos A, Kazis A, et al. Autologous stem cell transplantation in progressive multiple sclerosis: an interim analysis of efficacy. *J Clin Immunol* 20:24–30, 2000.
10. Tyndall A, Fassas A, Passweg J, et al. Autologous haematopoietic stem cell transplants for autoimmune disease: feasibility and transplant-related mortality. Autoimmune Disease and Lymphoma Working Parties of the European Group for Blood and Marrow Transplantation, the European League Against Rheumatism and the International Stem Cell Project for Autoimmune Disease. *Bone Marrow Transplant* 24:729–734, 1999.
11. McSweeney PA, Nash RA, Storb R, Furst D, Gauthier J, Sullivan KM. Autologous stem cell transplantation for autoimmune diseases: issues in protocol development. *J Rheumatol* 24 (Suppl 48):79–84, 1997.
12. Clement PJ, Furst DE. Choosing appropriate patients with SSc for treatment by autologous stem cell transplantation. *J Rheumatol* 24 (Suppl):85–88, 1997.



# **Autologous Hematopoietic Stem Cell Transplant Conditioning Regimens for the Treatment of Severe Autoimmune Diseases**

***Ashwin Kashyap, Jakob Passweg, Alan Tyndall***

*City of Hope National Medical Center (A.K.), Duarte, California;  
Division of Hematology (J.P.) and Division of Rheumatology (A.T.),  
Kantonsspital, Basel, Switzerland*

## **ABSTRACT**

Autologous hematopoietic stem cell transplantation is becoming more widely accepted as a potential therapeutic modality for selected patients with severe autoimmune diseases (SADs). Many aspects of the procedure remain highly controversial; not the least is the choice of conditioning regimen. We have initiated a retrospective analysis of the Basel database to evaluate the potential risks and benefits of different conditioning regimens employed in the treatment of SADs. Of 263 patients reported to the registry, 234 are currently evaluable. Fifty-one of these patients underwent high-intensity conditioning (group 1); 75 underwent intermediate-intensity (group 2) and 108 low-intensity (group 3) conditioning. Analysis was performed for 1-year treatment-related mortality (TRM), progression, and progression-free survival. High-intensity conditioning is associated with significantly higher 1-year TRM compared with the other 2 groups. Although disease response was seen in each group at 1 year of actuarial follow-up, there appears to be no advantage, in terms of disease control, from high-intensity conditioning. It must be emphasized that this is a preliminary analysis. Completion of this analysis, with further follow-up, may help guide the choice of conditioning regimens for the treatment of SADs.

## **INTRODUCTION**

Autologous peripheral blood stem cell transplantation (PBSCT) has emerged as an investigational therapy for the treatment of severe autoimmune diseases, and the number of patients undergoing transplantation for these diseases is rising annually.<sup>1</sup> However, many aspects of the procedure remain highly controversial, including disease indication, patient selection, purging, and—not least—the choice of

conditioning regimen. The latter has to take into account not only the usual potential short- and long-term risks associated with transplantation in general, but also specific risks as they apply to individual SADs in this setting. Furthermore, conditioning regimen toxicities have to be weighed carefully against their potential efficacy, which is extremely variable in this heterogeneous group of diseases and patients.

Herein, we report the results of a retrospective review of the Basel database, with a particular emphasis on the conditioning regimens employed, to guide planning of future clinical trials.

## **METHODS**

We retrospectively reviewed the Basel database, identifying and categorizing the conditioning regimens employed into 3 groups. These groups were defined according to their relative immunoablative intensities.

### **Group 1**

Group 1 received high-intensity regimens using agents that are sufficiently immunoablative to allow a standard allogeneic or matched unrelated donor bone marrow transplant—specifically, busulfan- or radiation-based conditioning regimens.

### **Group 2**

Group 2 received intermediate-intensity regimens that have been employed in the treatment of hematologic malignancies in the autologous transplant setting—specifically, BEAM (BCNU, etoposide, cytosine arabinoside, and melphalan) or BEAM-like regimens.

### **Group 3**

Group 3 received lower-intensity regimens that have been used in unique settings to facilitate transplantation, such as aplastic anemia, or have not been used as transplant regimens before this experience and are predominantly used as part of a standard nontransplant chemotherapeutic/immunosuppressive approach—specifically, cyclophosphamide- or fludarabine-based regimens.

## **Statistical Analysis**

Univariate analysis for 1-year TRM, progression, and progression-free survival was performed.

## RESULTS

Of the 263 patients reported to the Basel database, 234 are currently evaluable. The primary disease indications for transplantation were multiple sclerosis, systemic sclerosis, rheumatoid arthritis, and juvenile chronic arthritis. These 4 disorders comprised more than three quarters of all patients treated.

Fifty-one of the patients (22%) were treated with a high-intensity conditioning regimen (group 1), 75 (32%) an intermediate-intensity conditioning regimen (group 2), and 108 (46%) with a low-intensity conditioning regimen (group 3). The 1-year actuarial TRM, progression, and progression-free survival rates are shown in Table 1. TRM was significantly higher in group 1 compared with the other groups ( $P=.008$ ) (Figure 1). Whereas all conditioning regimens appear to have had an impact on disease, the progression and progression-free survival rates are not significantly different between the groups.

## CONCLUSIONS

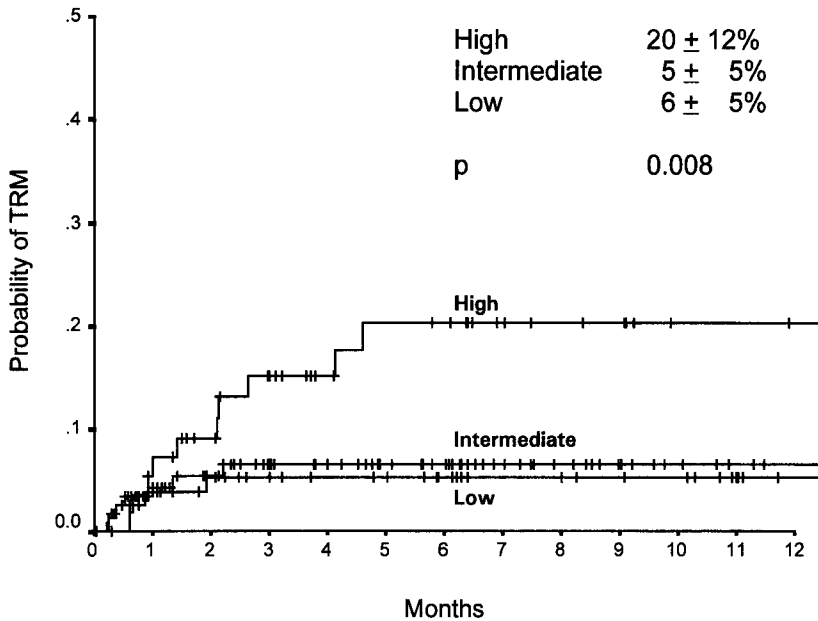
This preliminary analysis suggests that high-intensity conditioning in this patient population may be associated with significant TRM. This may be acceptable if a greater degree of disease control can be achieved; however, the present analysis does not support that conclusion. This finding may be due to a variety of factors, not necessarily a lack of efficacy.

This is a very preliminary analysis and must be interpreted with great caution. The database is heterogeneous and has been retrospectively analyzed. Furthermore, analysis for confounding factors, such as diagnosis, disease status, etc, and subgroup and multivariate analyses are still ongoing. Additionally, although there appears to be no difference in efficacy among the different regimens at 1 year, the follow-up for these diseases, which have relatively long natural histories, is far too short to be conclusive.

**Table 1.** One-Year Transplant-Related Mortality (TRM), Progression, and Progression-Free Survival (PFS) Stratified According to Intensity of Conditioning Regimen\*

Group	Conditioning Regimen	TRM	Progression	PFS	Total
1 (high)	fTBI- and busulfan-based	11 (22)	17 (33)	23 (45)	51 (22)
2 (intermediate)	BEAM and BEAM-like	4 (5)	17 (23)	54 (72)	75 (32)
3 (low)	Cyclophosphamide- and fludarabine-based	7 (7)	45 (42)	56 (52)	108 (46)
Total					234 (100)

\*Data are n (%). BEAM, BCNU, etoposide, cytosine arabinoside, and melphalan; fTBI, fractionated total body irradiation.



**Figure 1.** Treatment-related mortality (TRM) according to treatment regimen intensity.

### Theoretical Considerations of Different Conditioning Regimens

**Radiation-Based Regimens.** Radiation-based regimens are attractive principally because of efficacy; animal data from Van Bekkum<sup>2</sup> suggest that they can be efficacious in this setting. Radiation is known to be highly immunosuppressive in humans, with very low graft rejection rates after allogeneic or matched unrelated donor transplantation, even with some degree of histoincompatibility.<sup>3</sup> The main concern with the use of radiation-based regimens is their potential toxicity. Short-term toxicity is of concern in this group of patients. Preliminary experience suggests that in patients who have significant underlying organ system damage (from disease or prior therapy), the use of radiation may accentuate the risk of toxicity (eg, scleroderma patients suffering lung toxicity) (P. McSweeney, Worcester Meeting on Transplantation for Auto-Immune Diseases, October 1999). There are also concerns regarding the serious long-term toxicities of radiation, especially the development of secondary malignancies such as myelodysplastic syndrome and solid tumors.<sup>4</sup>

**Oral Busulfan.** Oral busulfan has long been used as an allogeneic transplant conditioning regimen agent because of its profound myeloablative properties.<sup>3</sup> This agent is also highly immunoablative—it has been used extensively to overcome

immunologic barriers and facilitate standard allogeneic and matched unrelated donor transplants with low graft rejection rates.<sup>5</sup> The main disadvantage of this agent is its very variable bioavailability.<sup>6</sup> This may be a contributing factor to both the relatively high incidence of veno-occlusive disease of the liver associated with this drug and the increased incidence of graft rejection, compared with radiation based regimens, when plasma levels are either too high or too low, respectively.<sup>5,7</sup>

**Cyclophosphamide-Based Regimens.** Cyclophosphamide has relatively low toxicity even in the dose-escalated setting. The cardiotoxicity associated with this drug is of concern in this patient population, because some patients have pre-existing cardiac disease related to their underlying disorders. The adequacy of efficacy is also of some theoretical concern. Initial experiences with aplastic anemia patients undergoing allogeneic transplantation using cyclophosphamide alone showed a high graft rejection rate, suggesting a relative lack of immunosuppression.<sup>8</sup> On the other hand, this agent is known to suppress T-cell function and has been used extensively, palliatively, as a therapy for the treatment of autoimmune diseases and, more recently, in a dose-escalated manner without stem cell support for the treatment of selected patients with autoimmune diseases.<sup>9</sup>

**Fludarabine-Based Regimens.** Fludarabine is in some respects an attractive, if somewhat novel, choice. It is relatively nontoxic in low doses, as in therapy for the treatment of hematologic malignancies (eg, low-grade non-Hodgkin's lymphoma) in the nontransplant setting. It is also clearly immunosuppressive, being a key component of many allogeneic mini-transplant regimens. Unfortunately, the efficacy of this agent in standard doses for the treatment of autoimmune diseases is largely untested. Furthermore, there is very little experience with the use of fludarabine as part of an autologous PBSCT conditioning agent for hematologic malignancies. Initial experience with fludarabine at higher doses (eg, treatment of acute myeloid leukemia) suggested that it was relatively toxic, leading to prolonged neutropenia.<sup>10</sup> The cause of this prolonged neutropenia is unclear, and it is also unclear whether this drawback can be overcome by performing autologous PBSCT. Furthermore, when dispensed in a dose-escalated manner, this agent does have other serious toxicity, especially neuropathy.<sup>10</sup>

**BEAM.** This conditioning regimen has been extensively used, particularly in Europe, for autologous transplantation. It is generally well tolerated; the BCNU component is of some theoretical concern, because it can cause significant late lung toxicity which, again, may be additive to other underlying lung problems in this patient population.<sup>11</sup> The ability to give mini-BEAM without stem cell support suggests that the myeloablative effect of BEAM is also limited compared with some of the other regimens.<sup>12</sup>

**Intravenous Busulfan.** Because of the limitations of the above regimens, at City of Hope, we have chosen to use intravenous busulfan in conjunction with cyclophosphamide and antithymocyte globulin as our conditioning regimen of

choice for this group of patients. Intravenous busulfan has significantly lower toxicity—especially VOD—compared with oral busulfan, which may be due to the lack of a liver first-pass effect.<sup>13</sup> The intravenous administration of this drug also ensures high bioavailability, maximizing the known immunosuppressive effect of busulfan (W.P. Vaughan, P. Cagnoni, H. Fernandez, et al. Pharmacokinetics of intravenous busulfan in hematopoietic stem cell transplantation (HSCT). American Society of Blood and Marrow Transplantation Meeting, Keystone, CO, March 1999, Abstract 78). However, this agent has only recently become widely available and is currently a relatively novel choice for the treatment of both hematologic malignancies and autoimmune diseases.

### SUMMARY

Autologous peripheral blood stem cell transplantation is becoming established as an investigational therapy for the treatment of severe autoimmune diseases. Many aspects of this procedure remain highly controversial. The available data, to date, are very limited and difficult to interpret. Preliminary analysis suggests that high-intensity conditioning regimens may be associated with significant treatment-related mortality with as yet unknown efficacy. Furthermore, all conditioning regimens employed to date have significant disadvantages that are counterbalanced by advantages which are as yet largely theoretical.

### ACKNOWLEDGMENTS

This investigation was supported by NCI PPG CA 30206 and NCI CA 33572.

### REFERENCES

1. Passweg J, Gratwohl A, Tyndall A. Hematopoietic stem cell transplantation for autoimmune disorders. *Curr Opin Hematol* 6:400–405, 1999.
2. Van Bekkum DW. BMT in experimental autoimmune disease. *Bone Marrow Transplant* 11:183–187, 1993.
3. Bensinger W, Buckner CD. Preparative regimens. In: Thomas ED, Blume K, Forman SJ, eds. *Hematopoietic Cell Transplantation*. Oxford, UK, Blackwell Science, 1999, p. 123–134.
4. Armitage J. Myelodysplasia and acute leukemia after autologous bone marrow transplantation. *J Clin Oncol* 18:945–946, 2000.
5. Slattery JT, Sanders JE, Buckner CD, et al. Graft rejection and toxicity following bone marrow transplantation in relation to busulfan pharmacokinetics. *Bone Marrow Transplant* 16:31–42, 1995.
6. Grochow I. Busulfan disposition: the role of therapeutic monitoring in bone marrow transplantation induction regimens. *Semin Oncol* 20:18–25, 1993.

7. McDonald GB, Hinds MS, Fisher LD, et al. Venous-occlusive disease of the liver and multiorgan failure after bone marrow transplantation: a cohort study of 355 patients. *Ann Intern Med* 118:255–267, 1993.
8. Storb R. Allogeneic marrow transplantation in patients with aplastic anemia. *Marrow Transplant Rev* Fall, 1993, p. 33–48.
9. Brodsky RA, Petri M, Smith BD, et al. Immunoablative high dose cyclophosphamide without stem cell rescue for refractory, severe autoimmune disease. *Ann Intern Med* 12: 1031–1035, 1998.
10. Von Hoff DD: Phase I clinical trials with fludarabine phosphate [review]. *Semin Oncol* 17 (5 Suppl 8):33–38, 1990.
11. Phillips GL, Fay JW, Herzig GP, et al. Intensive 1,3-bis(2-chloroethyl)-1-nitrosourea (BCNU), NSC #4366650 and cryopreserved autologous marrow transplantation for refractory cancer: a phase I-II study. *Cancer* 10:1792–1802, 1983.
12. Colwill R, Crump M, Couture F, et al. Mini-BEAM as salvage therapy for relapsed or refractory Hodgkin's disease before intensive therapy and autologous bone marrow transplantation. *J Clin Oncol* 2:396–402, 1995.
13. Kashyap A, Wingard J, Cagnoni P, et al. Intravenous (IV) vs. oral busulfan (BU) as part of a Bu/Cy (cyclophosphamide) preparative regimen for allogeneic hematopoietic stem cell transplantation (HSCT): decreased incidence of hepatic veno-occlusive disease (VOD), VOD related mortality and overall 100-day mortality [abstract]. *Bone Marrow Transplant* 25:81, 2000.





**CHAPTER 5**  
**POSTTRANSPLANT AND**  
**TARGETED THERAPY**



# Antibody-Targeted Therapy of Acute Myeloid Leukemia: An Update

**Dana C. Matthews, Eric L. Sievers, Frederick R. Appelbaum, Janet Eary, Katherine Ruffner, Irwin D. Bernstein**

*Division of Clinical Research (D.C.M., E.L.S., F.R.A., K.R., I.D.B.), Fred Hutchinson Cancer Research Center; Departments of Pediatrics (D.C.M., E.L.S., I.D.B.), Medicine (F.R.A., K.R.), and Radiology (J.E.), University of Washington, Seattle, Washington*

## ABSTRACT

Conventional treatments for acute myeloid leukemia (AML) have high rates of toxicity yet fail to cure the majority of patients. Over the past decade, monoclonal antibodies reactive with hematopoietic antigens have been used to deliver cytotoxic moieties, including radioisotopes and drugs, to leukemic cells with the goal of providing effective antileukemic treatment while minimizing toxicity.

The ability to deliver high doses of radiation to leukemic cells using anti-CD33 antibody labeled with iodine-131 ( $^{131}\text{I}$ ) was limited by internalization of the antibody-antigen complex and subsequent dehalogenation, as well as by the small amount of  $^{131}\text{I}$  with which saturating doses of antibody could be labeled. Recently, however, phase 1 studies using anti-CD33 antibody labeled with yttrium-90 ( $^{90}\text{Y}$ ) or bismuth-213 ( $^{213}\text{Bi}$ ) have demonstrated the delivery of significant doses of radiation to sites of leukemic involvement without excessive nonhematopoietic toxicity, and phase 2 studies are planned.

Radiolabeled antibodies have also been used to target CD45, a broadly expressed hematopoietic antigen found on immature and mature leukocytes and most acute leukemias. Almost 90% of patients with acute leukemia in remission or relapse have had favorable biodistribution of [ $^{131}\text{I}$ ]anti-CD45 antibody, with higher estimated radiation doses to marrow and spleen than to normal organs. Appreciable doses of marrow and spleen radiation have been delivered by [ $^{131}\text{I}$ ]anti-CD45 antibody when combined with cyclophosphamide and 12 Gy total body irradiation (TBI) in patients with advanced AML and acute lymphoblastic leukemia (ALL) receiving stem cell transplants, a regimen that is currently being studied in phase 2 clinical trials. Patients with AML in first remission receiving [ $^{131}\text{I}$ ]BC8 antibody combined with busulfan and cyclophosphamide have had encouragingly low relapse rates in an ongoing phase 2 study. Targeted hematopoietic irradiation is

also being combined with a nonmyeloablative transplant regimen in patients older than 50 years with relapsed or refractory AML.

For drug-antibody conjugates, the rapid internalization of the CD33 antigen-antibody complex provides an advantage because it allows rapid access of the toxic moiety to intracellular machinery. Such a conjugate, gemtuzumab ozogamicin (CMA-676; Mylotarg), links the potent antitumor antibiotic calicheamicin to a humanized anti-CD33 antibody. This agent, recently approved for the treatment of patients older than 60 years with relapsed CD33<sup>+</sup> AML, has induced remissions in 30% of 142 patients with AML in untreated first relapse treated on 3 phase 2 trials, with an acceptable toxicity profile. Current clinical trials of antibody-delivered therapy in AML will better define its efficacy, toxicity, and appropriate place in the management of these patients.

## INTRODUCTION

Acute myeloid leukemia remains a difficult disease to treat. Fewer than half of newly diagnosed patients can be cured with conventional chemotherapy, and the most effective chemotherapy regimens require multiple courses of near-myeloablative doses of anthracyclines and cytosine arabinoside. In addition to prolonged pancytopenia, such treatment is associated with risks of mucositis, typhlitis, and cardiac damage. For patients achieving a remission of their leukemia, many undergo hematopoietic stem cell transplantation (HSCT) if an appropriate HLA-matched related donor is available. Yet despite the intensive myeloablative systemic therapy administered as a preparative regimen before transplantation and its associated toxicity, up to 30% of patients relapse following the procedure. For patients with AML that is refractory to primary treatment or that has relapsed after conventional chemotherapy, HSCT offers the only chance of cure. However, relapse rates are high, with a >60% rate predicted for patients transplanted for chemotherapy-refractory disease.

One general approach to decrease relapse in patients with AML has been to intensify therapy. For example, the addition of multiple courses of high-dose cytosine arabinoside has improved the rate of disease-free survival for patients receiving chemotherapy. For patients undergoing HSCT, higher-intensity preparative regimens have resulted in decreased relapse rates but higher rates of transplant-related mortality. For example, in a prospective randomized trial for patients with AML in first remission receiving HLA-matched related bone marrow transplants comparing 2 doses of TBI, administered in addition to cyclophosphamide, the relapse rate was 12% in patients receiving 15.75 Gy compared with 35% in patients receiving 12 Gy.<sup>1</sup> In a similar trial in patients with CML in chronic phase, the relapse rate was 0% in patients receiving 15.75 Gy compared with 25% in patients receiving 12 Gy.<sup>2</sup> However, in each study the higher TBI dose was

associated with higher rates of transplant-related mortality, and thus there was no difference in disease-free survival between the TBI dose groups. These studies suggest that for both chemotherapeutic agents and radiation, there is a fairly steep dose-response curve for AML which could be exploited if toxicity to normal organs could be limited.

One means of limiting the toxicity of treatment to normal tissues would be to target the delivery of toxic moieties directly to leukemic cells. Since the development of monoclonal antibody technology by Kohler and Milstein<sup>3</sup> in the 1970s, there has been the hope that antibodies reactive with antigens expressed by tumor cells would provide effective, nontoxic treatment for malignancies. Initially, most of the experience using unmodified antibodies was disappointing, with the extent of tumor cell kill limited by the capacity of the patient's immune system to mediate antibody-dependent cellular cytotoxicity. Recently, however, the development of particular antibodies that have been manipulated to enhance antibody-mediated cell kill has led to significant disease responses in patients with lymphoma receiving humanized anti-CD20 antibody<sup>4,5</sup> and those with breast cancer treated with antibody reactive with the Her-2-neu antigen.<sup>6,7</sup> Patients with AML have been treated with a humanized antibody reactive with the myeloid CD33 antigen, with the suggestion that it may decrease the load of minimal residual disease in acute promyelocytic leukemia.<sup>8</sup>

Whereas unlabeled antibodies may be effective in several specific disease states, an additional use of antibody in patients with bulk disease might be as a means to deliver a toxic moiety to the cell, thus avoiding the dependence on antibody-dependent cell cytotoxicity for cell kill. Both radioisotopes and drugs have been conjugated to antibodies reactive with hematopoietic antigens and used to treat patients with AML in various stages, with or without transplantation. AML represents an attractive target for immunoconjugate therapy because the leukemic cells are rapidly accessible given their presence in well-vascularized tissues such as marrow and spleen, and because of the steep dose-response curve of AML to many therapeutic agents.

The principles involved in antibody-directed therapy are different for radioisotopes as opposed to drugs. When using radiolabeled antibodies, the radiation from an antibody bound to a given cell may actually be deposited anywhere within a sphere defined by the pathlength of the isotope. When using an isotope with a pathlength longer than a few cell diameters, antibody does not necessarily need to bind to every leukemic cell to kill every cell as long as antibody is bound regionally. This bystander effect may kill rare leukemic cells that do not express the target antigen or that are not reached by antibody if the majority of cells in the involved tissue bind antibody. However, there is also the potential for nonspecific cell killing if normal cells are near the cells bound by antibody or from prolonged circulation of radiolabeled antibody. In contrast, drug-antibody

conjugates must bind to each malignant cell because cell kill requires internalization of the toxic moiety. These differences between radiolabeled antibody and drug-antibody conjugates may affect the selection of the target antigen, as described below. The majority of immunoconjugate studies in AML performed to date have used antibodies reactive with the CD33 or CD45 antigens.

### CD33 ANTIGEN

The CD33 antigen is expressed by myeloid progenitor cells in marrow, although it is absent from the hematopoietic stem cell.<sup>9</sup> More than 90% of patients with AML have leukemia blasts that express this antigen.<sup>10</sup> Its level of expression is variable, although it is often expressed at fairly low copy numbers. Importantly, the antibody-CD33 antigen complex internalizes after binding by antibody.<sup>11</sup> In addition to its recent use as an unlabeled antibody, anti-CD33 antibody has been used both as a radioimmunoconjugate and as a drug-antibody conjugate.

### RADIOLABELED ANTI-CD33 ANTIBODY

Initial studies used anti-CD33 antibodies labeled with <sup>131</sup>I. <sup>131</sup>I has a half-life of 8 days, and has both a beta decay with a pathlength of 0.7 mm and a gamma component that allows the quantitative determination of antibody localization in patients by gamma camera imaging, but which necessitates that patients be treated in radiation isolation. Studies by Schwartz et al.<sup>12</sup> and Appelbaum et al.<sup>13</sup> examined the biodistribution of trace <sup>131</sup>I-labeled M195 and p67 murine antibodies, respectively, in patients with AML beyond first remission. For each anti-CD33 antibody, the antibody dose resulting in optimal biodistribution was low (<5 mg/m<sup>2</sup>) because the relative numbers of CD33 antigen sites were rapidly saturated and the circulation of unbound antibody at higher antibody doses led to increased radiation delivery to nontarget organs. For [<sup>131</sup>I]p67 antibody, the retention in marrow was relatively brief (average half-life 17 hours) because of prompt internalization of the antibody-antigen complex and dehalogenation of antibody with rapid excretion of small <sup>131</sup>I-containing moieties. Consequently, only 4 of 9 patients receiving a biodistribution dose of trace [<sup>131</sup>I]p67 antibody had favorable biodistribution of antibody, defined as a higher estimated radiation dose to marrow and spleen than to nontarget organs, and the ratios of radiation delivered to target compared with nontarget organs were low. Although phase I transplant studies combining [<sup>131</sup>I]M195 antibody with busulfan and cyclophosphamide<sup>14</sup> and [<sup>131</sup>I]p67 antibody with cyclophosphamide and 12 Gy TBI<sup>13</sup> were initiated, both groups of investigators have abandoned the use of [<sup>131</sup>I]anti-CD33 antibody because of the relatively limited radiation doses that can be delivered by 5 mg/m<sup>2</sup> antibody without damaging the antigen-binding capacity of the antibody by radiolysis.

Instead, investigators at Memorial Sloan Kettering Cancer Center have examined the biodistribution of humanized M195 (HuM195) antibody labeled with alternative isotopes,  $^{90}\text{Y}$  and  $^{213}\text{Bi}$ .  $^{90}\text{Y}$  has a half-life of 2.7 days and is a pure beta emitter with a higher energy and thus a longer pathlength, 5 mm, than that of  $^{131}\text{I}$ . The absence of a gamma component means that patients do not require radiation isolation during treatment. Because precise quantitation of  $^{90}\text{Y}$ -antibody localization by gamma camera imaging is not possible, the biodistribution of  $^{90}\text{Y}$ -labeled antibody must be inferred from that of antibody labeled with a surrogate gamma-emitting isotope, indium-111 ( $^{111}\text{In}$ ). In a phase 1 nontransplant study in patients with relapsed AML, 18 patients received HuM195 antibody labeled with 0.1 to 0.3 mCi  $^{90}\text{Y}$ /kg on 3.5 to 6 mg antibody.<sup>15</sup> Nine patients received  $^{111}\text{In}$ -labeled antibody at the same time to allow estimation of antibody biodistribution. Estimated radiation doses of 2.9 to 7 Gy were delivered to marrow and 1.3 to 3.1 Gy to liver. The maximum tolerated dose (MTD) was estimated to be 0.275 mCi/kg, with prolonged myelosuppression (>35 days) in patients treated at 0.3 mCi/kg. A decrease in peripheral blasts was seen in 12 of 13 patients, with a decrease in marrow blasts in 12 of 16 patients. Five of 8 patients treated with 0.275 to 0.3 mCi/kg developed transient empty marrow, and 1 of these patients achieved a complete remission. This group now plans a phase 2 study of 0.275 mCi/kg [ $^{90}\text{Y}$ ]M195 antibody in patients with relapsed AML not receiving HSCT. For younger patients with autologous stem cells available, they plan a phase 1 study to determine the MTD of [ $^{90}\text{Y}$ ]M195 antibody that can be combined with high-dose etoposide followed by autologous HSCT.

A second study at Memorial Sloan Kettering Cancer Center is the first to use antibody labeled with an alpha particle emitter in the treatment of AML.<sup>16</sup> In contrast to beta particles, alpha particles have high energy but are very large and thus have a short pathlength, such as the 50- to 80- $\mu\text{m}$  pathlength for  $^{213}\text{Bi}$ . Most available alpha particles have a very short half-life, and the 46-minute half-life for  $^{213}\text{Bi}$  necessitates that the antibody be administered immediately after radiolabeling. It is also critical that the antibody have rapid access to target cells to reach the cells before radioisotope decay. In a phase 1 nontransplant trial in 17 patients with relapsed AML, doses of 0.28 to 1.0 mCi  $^{213}\text{Bi}$ /kg were administered over 2 to 4 days in 3 to 6 fractions. Early scans demonstrated localization of isotope in marrow, spleen, and liver within 10 minutes of infusion, with better localization to marrow with later as opposed to earlier infusions. The MTD was 1 mCi/kg, with myelosuppression lasting up to 34 days in patients treated at the highest dose levels. No complete responses were observed, but there was a decrease in percentage of blasts in marrow in 12 of 17 patients. Estimated radiation doses were 656 to 4676 centisieverts (cSv) (a radiation dose equivalent unit equal to 1 rem that incorporates the biologic effect of alpha particle radiation) to bone marrow, 290 to 4399 cSv to spleen, and 242 to 2752 cSv to liver, with much lower doses to other organs and to the total body. Because of

the technical difficulties inherent in delivering large doses of alpha-emitting radioisotopes, these investigators are now focusing on treating patients with less bulk disease. Therefore, their next phase I trial for patients with relapsed AML will incorporate low-dose cytosine arabinoside immediately before [ $^{213}\text{Bi}$ ]HuM195 antibody to allow for debulking before antibody administration. A second study will use [ $^{213}\text{Bi}$ ]HuM195 antibody as consolidation therapy directed toward minimal residual disease for patients with AML in second remission. The investigators hope that the very short pathlength of  $^{213}\text{Bi}$  will allow relative sparing of stem cells and thus delivery of substantial doses of radiotherapy to CD33-expressing leukemia cells.

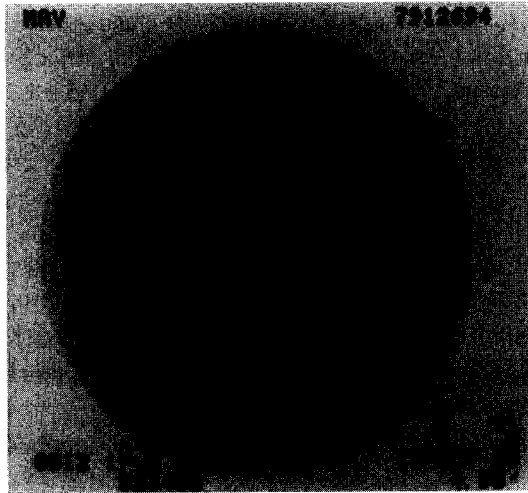
### CD45 ANTIGEN

In contrast to the relatively narrow expression and low copy numbers for the CD33 antigen, CD45 is broadly expressed by all leukocytes and their precursors,<sup>17</sup> at an average copy number of ~200,000 per cell. It is expressed by most AML and the majority of ALL samples<sup>18,19</sup> and is not appreciably internalized after binding by antibody.<sup>11</sup> The CD45 antigen is a potential target antigen for ALL in addition to AML because it is expressed by both lymphoid and myeloid cells, and thus radiolabeled anti-CD45 antibody should deliver radiation to lymph nodes as well as bone marrow and spleen. Because it is expressed by both normal and malignant cells in these tissues, radiolabeled anti-CD45 antibody can be used to deliver radiation to marrow, spleen, and lymph nodes for patients with acute leukemia whether in remission or relapse. For patients in remission, even blasts not expressing CD45 should be killed if surrounded predominantly by nonmalignant hematopoietic cells, because of the bystander effect.

### RADIOLABELED ANTI-CD45 ANTIBODY

Preclinical studies in both mice and macaques demonstrated that [ $^{131}\text{I}$ ]anti-CD45 antibody could deliver more radiation to marrow, spleen, and lymph nodes than to any nontarget organs, with estimated radiation doses to marrow and lymph nodes that were 2 to 8 times that of the highest normal organs.<sup>20,21</sup> A phase I clinical trial was then performed to determine the biodistribution of trace [ $^{131}\text{I}$ ]anti-CD45 antibody in patients in remission and in relapse, to ascertain factors influencing antibody biodistribution, and to estimate the MTD of radiation delivered by antibody that could be combined with the conventional transplant preparative regimen of cyclophosphamide and 12 Gy TBI.<sup>22,23</sup> Eligible patients were those at high risk of relapsing posttransplant, including those with advanced (eg, primary refractory or beyond first remission) acute myeloid or lymphoid leukemia or myelodysplastic syndrome (MDS), with HLA-matched related donors or autologous HSCs available.





**Figure 1.** [Iodine-131]anti-CD45 antibody localization: anterior gamma camera image of pelvis 17 hours after infusion of 0.5 mg/kg trace <sup>131</sup>I-labeled BC8 (anti-CD45) antibody in a patient with acute myeloid leukemia in first remission.

Patients first received a biodistribution infusion of 0.5 mg/kg BC8 antibody, a murine immunoglobulin G1 (IgG1) reactive with all human CD45 isoforms, which was labeled with 5–8 mCi <sup>131</sup>I. This was followed with serial quantitative gamma camera scanning (Figure 1) and a least 1 bone marrow biopsy. The time-activity curves for concentration of <sup>131</sup>I in marrow, spleen, liver, lungs, kidney, and total body were used to estimate radiation doses delivered, as cGy per mCi <sup>131</sup>I, by applying methods consistent with those recommended by the Society of Nuclear Medicine's special committee on Medical Internal Radiation Dose.<sup>24–26</sup> Patients with higher estimated radiation doses to spleen and marrow than to liver, lung, and kidney (favorable biodistribution of antibody) were eligible to receive a therapy dose of antibody. The antibody, administered 13–14 days before HSCT, was labeled with the amount of <sup>131</sup>I estimated to deliver a predetermined dose to the normal organ receiving the highest dose, beginning at 3.5 Gy. The dose delivered by <sup>131</sup>I was subsequently escalated in cohorts of 3 to 6 patients. Patients were treated in radiation isolation, where they remained until the amount of radiation measured at 1 meter was less than 5 mR/h. After discharge, they received cyclophosphamide 60 mg/kg per day for 2 days and 2 Gy TBI per day for 6 days followed by autologous or allogeneic stem cell transplant. Graft-vs.-host disease (GVHD) prophylaxis for allogeneic recipients consisted of methotrexate and cyclosporine.

Forty-four patients with a median age of 38 years (range, 16–55 years) received a biodistribution dose of antibody. Thirty-one had AML (9 in remission, 22 in

relapse), 10 had ALL (5 in remission, 5 in relapse), and 3 had MDS. Eighty-four percent had favorable biodistribution of antibody, with mean estimated radiation absorbed doses (cGy/mCi  $^{131}\text{I}$ ) of  $6.5 \pm 0.5$  for marrow,  $13.5 \pm 1.3$  for spleen,  $2.8 \pm 0.2$  for liver,  $1.8 \pm 0.1$  for lung,  $0.6 \pm 0.04$  for kidney, and  $0.4 \pm 0.02$  for the total body. The liver was the normal organ receiving the highest estimated radiation absorbed dose in all but 1 patient. Antibody administration was associated with transient side effects including chills, nausea, vomiting, and mild hypotension in 75% of patients, with 25% developing transient respiratory side effects including sensation of chest or throat tightness or wheezing. Patients with AML in relapse had the highest estimated radiation dose to marrow because of both higher initial antibody uptake and longer retention of  $^{131}\text{I}$  in marrow, resulting in a higher ratio of radiation delivered to marrow than to liver.

Thirty-four patients received a therapy dose of antibody labeled with 76–613 mCi  $^{131}\text{I}$  estimated to deliver from 3.5 to 12.25 Gy to the normal organ receiving the highest dose. Dose-limiting regimen-related toxicity was seen in 1 of 6 patients (grade III veno-occlusive disease of the liver) treated at dose level 5, 10.5 Gy to liver, and in 2 of 2 patients treated at 12.25 Gy (grade III–IV mucositis), and thus the MTD was estimated to be 10.5 Gy. Although this phase 1 study was not designed to determine efficacy of this combined preparative regimen, 30% of the patients with advanced leukemia (7 of 25 with AML or MDS and 3 of 9 with ALL) survive disease free 38 to 112 months after transplantation. This study demonstrated that appreciable doses of supplemental targeted radiation to hematopoietic tissues (average estimated doses of 24 Gy to marrow and 50 Gy to spleen with an MTD of 10.5 Gy to liver) can be delivered when combined with cyclophosphamide and 12 Gy TBI. Based on this phase 1 study, parallel phase 2 studies of this preparative regimen are now under way for patients with advanced AML and advanced ALL with HLA-matched related or unrelated donors.

$^{131}\text{I}$ -labeled anti-CD45 antibody has also been used to intensify the antileukemic therapy administered to patients undergoing HLA-matched related transplantation for AML in first remission. In an ongoing phase 2 study combining [ $^{131}\text{I}$ ]BC8 antibody with busulfan and cyclophosphamide,<sup>27</sup> 90% of patients have had favorable biodistribution of trace-labeled antibody, and 37 patients have received a therapy dose of antibody labeled with the amount of  $^{131}\text{I}$  estimated to deliver 3.5 Gy (4 patients) or 5.25 Gy (33 patients) to the liver. Average estimated doses of 10.6 Gy to marrow and 28.6 Gy to spleen have resulted. Grade III mucositis developed in 2 patients, grade IV pneumonitis thought to be possibly related to the conditioning regimen was seen in 2 patients, and 1 patient died with multisystem failure at day 38 after a sepsis-like event and was found at postmortem examination to have pulmonary cytomegalovirus and hepatic GVHD. Four patients have relapsed, and 27 (73%) survive disease free 5–78 months (median, 47 months) after transplant. This study is continuing to accrue patients and is being expanded to

include 2 additional institutions, City of Hope National Medical Center and Stanford University Medical Center. The ultimate determination of whether the addition of targeted hematopoietic irradiation to busulfan/cyclophosphamide can improve disease-free survival will require a phase 3 randomized trial comparing this combined regimen with busulfan/cyclophosphamide alone.

The combination of radiolabeled anti-CD45 antibody and conventional preparative regimens may serve to decrease relapse rates but has not resulted in an improvement in the toxicities associated with HSCT. The ability to decrease the proportion of radiation delivered as TBI while increasing the amount delivered by antibody has the potential to both decrease toxicity and increase the total radiation dose delivered to hematopoietic tissues by taking advantage of the therapeutic ratio provided by targeting. In CD45 studies performed to date, full-dose, conventional therapy was included in part to ensure that the regimen was adequately immunosuppressive to prevent rejection of donor hematopoietic cells. However, several investigators have recently developed lower-dose, nonmyeloablative preparative regimens that have allowed engraftment of donor cells in patients who would be unlikely to tolerate conventional high-dose regimens.<sup>28,29</sup> The initial donor engraftment has resulted in measurable diminution of disease in the majority of patients, presumably from a graft-vs.-leukemia (GVL) effect, and some patients have received donor lymphocyte infusions after transplant to augment this effect. One such regimen, developed by Sandmeier et al.<sup>30</sup> at Fred Hutchinson Cancer Research Center, includes fludarabine plus 2 Gy TBI and posttransplant immunosuppression with the combination of cyclosporine and mycophenolate mofetil (MMF).

The availability of this well-tolerated nonmyeloablative regimen, which can establish donor engraftment with little toxicity, now provides an opportunity to increase the dose of radiation delivered by [<sup>131</sup>I]anti-CD45 antibody by combining it with this low-dose regimen in patients with advanced AML. The debulking provided by [<sup>131</sup>I]BC8 antibody, followed by 2 Gy TBI, cyclosporine, and MMF, may allow better control of acute leukemia and optimize the chance that the subsequent GVL effect will eradicate disease. A phase 1 trial to determine the MTD of radiation delivered by anti-CD45 antibody that can be combined with this nonmyeloablative regimen, beginning at a dose level of 12 Gy to liver, has been initiated. Eligible patients are patients with AML that is either primarily refractory or has recurred and who would be unlikely to tolerate conventional transplants, eg, patients between the ages of 50 and 70 with matched related or unrelated donors.

Other investigators have begun to examine the biodistribution and tolerability of anti-CD45 antibody labeled with <sup>90</sup>Y. In addition, elsewhere in this symposium, Martin et al. reported on their experience targeting a pan-myeloid antigen, CD66c, with antibody labeled with rhenium-188. The next several years should further our understanding of the role of these approaches in the treatment of acute leukemia.

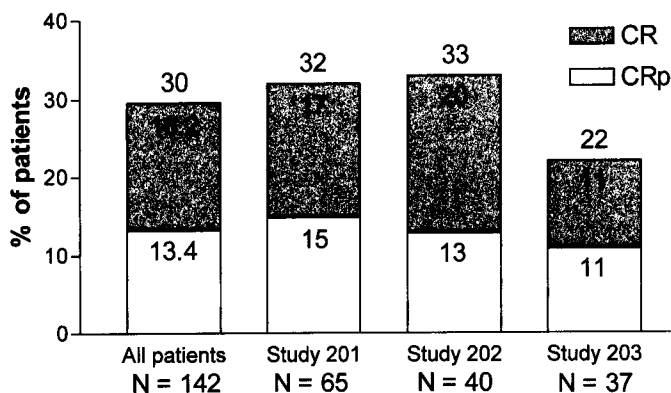
**ANTIBODY-TARGETED CHEMOTHERAPY: GEMTUZUMAB OZOGAMICIN**

The rapid internalization of the antibody-CD33 antigen complex makes the CD33 antigen an excellent target antigen for a drug-antibody conjugate where the drug must access intracellular contents to damage the cell. The antitumor antibiotic calicheamicin, which generates double-stranded DNA breaks after undergoing intracellular trisulfide reduction and molecular rearrangement with the formation of a diradical species, was thus conjugated to humanized p67.6 antibody<sup>31</sup> and was demonstrated to selectively kill AML blasts *in vitro*. A phase 1 dose escalation study in 40 patients with relapsed or refractory AML demonstrated that doses of up to 9 mg/m<sup>2</sup> of gemtuzumab ozogamicin (Mylotarg) were reasonably well tolerated. Reduction of blasts in marrow to <5% was seen in 8 of 40 patients, and the likelihood of clinical response appeared to be correlated with a low rate of dye efflux, indicative of low functional drug resistance.<sup>32</sup>

Combined results of 3 open-label multicenter phase 2 trials using Mylotarg in patients with AML in untreated first relapse were recently presented.<sup>33</sup> Patients were eligible for these studies if they were >18 years of age (>60 years in 1 study); had a first remission that was at least 6 months in duration (>3 months in 1 study); had blasts that expressed the CD33 antigen, a circulating white blood cell count <30,000/mm<sup>3</sup>, and normal renal and hepatic function; and did not have secondary AML or a history of an antecedent hematologic disorder. Two doses of Mylotarg at 9 mg/m<sup>2</sup> were administered intravenously over 2 hours separated by a 2-week interval.

One hundred forty-two patients were treated on these 3 studies (Figure 2). Remission, defined as <5% blasts in marrow, an absolute neutrophil count to >1500/mm<sup>3</sup>, and red cell and platelet transfusion independence, was achieved in 30% of patients, including 34% of the 62 patients <60 years of age and 26% of the 80 patients older than 60 years. The treatment was generally well tolerated. A postinfusion symptom complex (fever, chills, and, less commonly, hypotension and dyspnea) was similar to that seen with other antibody-based therapies and occurred despite prophylactic treatment with acetaminophen and antihistamines. The incidences of grade 3 or 4 mucositis (4%), nausea and vomiting (11%), and infections (28%) were relatively low. There was no reported treatment-related cardiotoxicity, cerebellar toxicity, renal failure, or alopecia.

Grade 3 or 4 hepatic toxicity was seen in 17% (elevated aspartate/alanine transaminase [AST/ALT]) to 23% (elevated bilirubin) of patients. In most cases, these changes were transient, allowing delivery of the second dose of drug. Although the median hospital stay was 24 days, due primarily to the neutropenia and thrombocytopenia that developed in virtually all patients, 16% of patients had hospital stays of no more than 1 week. Based on the favorable safety profile of this therapy when administered as a single agent, Mylotarg was recently approved by



**Figure 2.** Response to gemtuzumab ozogamicin (Mylotarg) in acute myeloid leukemia in untreated first relapse: rates of response to Mylotarg in 3 phase 2 studies. Patients were >18 years old (>60 years in study 203) with an initial remission of at least 6 months (>3 months in study 203). Responses were scored as either complete response (CR) or complete response with delayed platelet recovery (CRp).

the US Food and Drug Administration (FDA) for use in patients >60 years of age with CD33-positive AML in first relapse who are not thought to be candidates for conventional cytotoxic chemotherapy. Current studies of this agent are under way in pediatric patients, in combination with other chemotherapeutic agents earlier in the disease course and as a means of debulking AML in patients immediately before nonmyeloablative HSCT.

## CONCLUSIONS

More than 2 decades after the initial development of monoclonal antibody technology, several recent studies suggest that antibodies reactive with hematopoietic antigens and conjugated with cytotoxic moieties such as radioisotopes or drugs can improve the selectivity of therapy and thus may offer important new treatment options for patients with AML. Phase 1 and 2 studies of radiolabeled antibodies have demonstrated the ability to deliver more radiation to hematopoietic tissues than to normal organs and that appreciable doses of such targeted radiation can be tolerated in transplant and nontransplant settings. Mylotarg is the first antibody-targeted chemotherapeutic agent to receive FDA approval, and growing experience with its use in several settings will provide more information regarding its potential roles in AML therapy. Ongoing preclinical studies may demonstrate better targeting using alternative antibodies, isotopes, or

approaches designed to decrease nonspecific radiation by clearing residual circulating antibody. Ultimately, optimum management of AML may include combinations of antibody-mediated and conventional therapies.

### ACKNOWLEDGMENTS

This work was supported in part by National Institute of Health Grant CA44991. D.C.M. is a Clinical Scholar of the Leukemia and Lymphoma Society. E.L.S. is supported by an American Cancer Society Clinical Oncology Career Development Award. I.D.B. is a Clinical Research Professor of the American Cancer Society.

### REFERENCES

1. Clift RA, Buckner CD, Appelbaum FR, et al. Allogeneic marrow transplantation in patients with acute myeloid leukemia in first remission: a randomized trial of two irradiation regimens. *Blood* 76:1867–1871, 1990.
2. Clift RA, Buckner CD, Appelbaum FR, et al. Allogeneic marrow transplantation in patients with chronic myeloid leukemia in the chronic phase: a randomized trial of two irradiation regimens. *Blood* 77:1660–1665, 1991.
3. Kohler G, Milstein C. Continuous cultures of fused cells secreting antibody of pre-defined specificity. *Nature* 256:495–497, 1975.
4. Maloney DG, Liles TM, Czerwinski DK, et al. Phase I clinical trial using escalating single-dose infusion of chimeric anti-CD20 monoclonal antibody (IDEC-C2B8) in patients with recurrent B-cell lymphoma. *Blood* 84:2457–2466, 1994.
5. McLaughlin P, Grillo-Lopez A, Link BK, et al. Rituximab chimeric anti-CD20 monoclonal antibody therapy for relapsed indolent lymphoma: half of patients respond to a four-dose treatment program. *J Clin Oncol* 16:2825–2833, 1998.
6. Baselga J, Tripathy D, Mendelsohn J, et al. Phase II study of weekly intravenous recombinant humanized anti-p185HER2 monoclonal antibody in patients with HER2/neu-overexpressing metastatic breast cancer. *J Clin Oncol* 14:697–699, 1996.
7. Cobleigh MA, Vogel CL, Tripathy D, et al. Multinational study of the efficacy and safety of humanized anti-HER2 monoclonal antibody in women who have HER2-overexpressing metastatic breast cancer that has progressed after chemotherapy for metastatic disease. *J Clin Oncol* 17:2639–2648, 1999.
8. Jurcic JG, DeBlasio T, Dumont L, Yao TJ, Scheinberg DA. Molecular remission induction with retinoic acid and anti-CD33 monoclonal antibody HuM195 in acute promyelocytic leukemia. *Clin Cancer Res* 6:372–380, 2000.
9. Andrews RG, Takahashi M, Segal GM, Powell JS, Bernstein ID, Singer JW. The L4F3 antigen is expressed by unipotent and multipotent colony-forming cells but not by their precursors. *Blood* 68:1030–1035, 1986.
10. Dinndorf PA, Andrews RG, Benjamin D, Ridgway D, Wolff L, Bernstein ID. Expression of normal myeloid-associated antigens by acute leukemia cells. *Blood* 67:1048–1053,

- 1986.
11. van der Jagt RH, Badger CC, Appelbaum FR, et al. Localization of radiolabeled antimyeloid antibodies in a human acute leukemia xenograft tumor model. *Cancer Res* 52:89–94, 1992.
  12. Schwartz MA, Lovett DR, Redner A, et al. Dose-escalation trial of M195 labeled with iodine 131 for cytoreduction and marrow ablation in relapsed or refractory myeloid leukemias. *J Clin Oncol* 11:294–303, 1993.
  13. Appelbaum FR, Matthews DC, Eary JF, et al. The use of radiolabeled anti-CD33 antibody to augment marrow irradiation prior to marrow transplantation for acute myelogenous leukemia. *Transplantation* 54:829–833, 1992.
  14. Papadopoulos EB, Caron P, Castro-Malaspina H, et al. Results of allogeneic bone marrow transplant following <sup>131</sup>I-M195/busulfan/cyclophosphamide (BU/CY) in patients with advanced/refractory myeloid malignancies [abstract]. *Blood* 82:80a, 1993.
  15. Jurcic JG, Divgi CR, McDevitt MR, et al. Potential for myeloablation with yttrium-90-HuM195 (anti-CD33) in myeloid leukemia [abstract]. *J Clin Oncol* 19:8a, 2000.
  16. Jurcic JG, McDevitt MR, Sgouros G, et al. Phase I trial of targeted alpha-particle therapy for myeloid leukemias with bismuth-213-HuM195 (Anti-CD33) [abstract]. *J Clin Oncol* 18:7a, 1999.
  17. Omary MD, Trowbridge IS, Battifora HA. Human homologue of murine T-200 glycoprotein. *J Exp Med* 152:842–852, 1980.
  18. Andres TL, Kadin ME. Immunologic markers in the differential diagnosis of small round cell tumors from lymphocytic lymphoma and leukemia. *Am J Clin Pathol* 79:546–552, 1983.
  19. Caldwell CW, Patterson WP, Hakami N. Alterations of HLe-1 (T200) fluorescence intensity on acute lymphoblastic leukemia cells may relate to therapeutic outcome. *Leuk Res* 11:103–106, 1987.
  20. Matthews DC, Badger CC, Fisher DR, et al. Selective radiation of hematolymphoid tissue delivered by anti-CD45 antibody. *Cancer Res* 52:1228–1234, 1992.
  21. Matthews DC, Appelbaum FR, Eary JF, et al. Radiolabeled anti-CD45 monoclonal antibodies target lymphohematopoietic tissue in the macaque. *Blood* 78:1864–1874, 1991.
  22. Matthews DC, Appelbaum FR, Eary JF, et al. Development of a marrow transplant regimen for acute leukemia using targeted hematopoietic irradiation delivered by <sup>131</sup>I-labeled anti-CD45 antibody, combined with cyclophosphamide and total body irradiation. *Blood* 85:1122–1131, 1995.
  23. Matthews DC, Appelbaum FR, Eary JF, et al. Phase I study of <sup>131</sup>I-anti-CD45 antibody plus cyclophosphamide and total body irradiation for advanced acute leukemia and myelodysplastic syndrome. *Blood* 94:1237–1247, 1999.
  24. Society of Nuclear Medicine. *MIRD Primer for Absorbed Dose Calculations*. New York, NY: Society of Nuclear Medicine, 1988.
  25. Christy M, Eckerman KF. *Specific Absorbed Fractions of Energy at Various Ages From Internal Photon Sources*. Oak Ridge, TN: Oak Ridge National Laboratory, 1987.
  26. Fisher DR, Badger CC, Breitz H, et al. Internal radiation dosimetry for clinical testing of radiolabeled monoclonal antibodies. *Antibiot Immunconj Radiopharm* 4:655–664, 1991.
  27. Matthews DC, Appelbaum FR, Eary JF, Mitchell D, Press OW, Bernstein ID. <sup>131</sup>I-anti-

- CD45 antibody plus busulfan/cyclophosphamide in matched related transplants for AML in first remission [abstract]. *Blood* 88 (Suppl. 1):142a, 1996.
28. McSweeney P, Niederwieser D, Shizuru J, et al. Outpatient allografting with minimally myelosuppressive, immunosuppressive conditioning of low-dose TBI and postgrafting cyclosporine (CSP) and mycophenolate mofetil (MMF) [abstract]. *Blood* 94:393a, 1999.
  29. Giralt S, Weber D, Aleman A, et al. Nonmyeloablative conditioning with fludarabine/melphalan (FM) for patients with multiple myeloma [abstract]. *Blood* 94:347a, 1999.
  30. Sandmaier BM, Maloney DG, McSweeney P, et al. Nonmyeloablative conditioning for stem cell allografts with low-dose TBI: an update of toxicity and outcome [abstract]. *Exp Hematol* 28:60, 2000.
  31. Hinman LM, Hamann PR, Wallace R, Menendez AT, Durr FE, Upeslaciis J. Preparation and characterization of monoclonal antibody conjugates of the calicheamicins: a novel and potent family of antitumor antibiotics. *Cancer Res* 53:3336–3342, 1993.
  32. Sievers EL, Appelbaum FR, Spielberger RT, et al. Selective ablation of acute myeloid leukemia using antibody-targeted chemotherapy: a phase I study of an anti-CD33 calicheamicin immunoconjugate. *Blood* 93:3678–3684, 1999.
  33. Sievers EL, Larson RA, Estey E, et al. Comparison of the efficacy and safety of gemtuzumab ozogamicin (CMA-676) in patients <60 and >60 years of age with AML in first relapse [abstract]. *J Clin Oncol* 19:8a, 2000.



# Nonmyeloablative Allografting Following a Failed Autograft

*Stephen Mackinnon*

*Department of Haematology, University College Hospital, London, UK*

## ABSTRACT

We have investigated a novel nonmyeloablative conditioning regimen in 25 patients with hematologic malignancies. The median patient age was 32 years. All of the patients had failed a previous autologous transplant. Recipient conditioning consisted of CAMPATH-1H monoclonal antibody, 20 mg/d on days -8 to -4, fludarabine 30 mg/m<sup>2</sup> on days -7 to -3, and melphalan 140 mg/m<sup>2</sup> on day -2. Seventeen recipients received unmanipulated granulocyte colony-stimulating factor (G-CSF)-mobilized peripheral blood stem cells from HLA-identical siblings, and 8 received unmanipulated marrow from matched unrelated donors. Graft-vs.-host disease (GVHD) prophylaxis was with cyclosporin A (CsA). All evaluable patients had sustained engraftment. Results of chimerism analysis using microsatellite polymerase chain reaction (PCR) indicate that approximately half of the patients studied had full donor chimerism; the other patients had mixed chimerism in one or more lineages. At a median follow up of 10 months (range, 1 to 25 months) 19 patients remain alive in complete remission (CR) or with no evidence of disease progression. Three patients relapsed or progressed posttransplant; 2 of them subsequently died. Three patients died from regimen-related complications. There were no cases of grades III-IV acute GVHD. Only 2 patients developed grade I acute GVHD, and only 1 had chronic GVHD. Although longer follow-up is needed to establish the long-term remission rates, this study demonstrates that this nonmyeloablative preparative regimen is associated with durable engraftment, minimal toxicity, and low incidence of GVHD and is feasible in patients who have already failed an autologous stem cell transplant.

## INTRODUCTION

High-dose chemoradiotherapy followed by allogeneic stem cell transplantation (SCT) has been extensively used to treat patients with hematologic malignancies. This procedure is often limited to patients in good medical condition, due to the increased transplant-related mortality (TRM) and GVHD that occurs with

increasing age and poor performance status.<sup>1,2</sup> Patients who have previously failed an autologous stem cell transplant are at particularly high risk for very high TRM.

The curative potential of transplantation is not solely due to the conditioning regimen but also to the well-documented graft-vs.-leukemia (GVL) effect.<sup>3</sup> The most convincing evidence for this GVL effect is that donor leukocyte infusions (DLIs) can reinduce remissions in patients who have relapsed following allogeneic SCT.<sup>4,5</sup> Patients with chronic myeloid leukemia are most likely to respond, but responses have also been documented in patients with acute leukemia, chronic lymphocytic leukemia, myeloma, and lymphoma.<sup>6,7</sup>

In an effort to reduce the TRM associated with allogeneic SCT, low-intensity fludarabine-based regimens have been developed.<sup>8-11</sup> These have been designed to be immunosuppressive rather than myeloablative to facilitate donor engraftment and thereby limit systemic toxicity. There appears to be a spectrum of hematopoietic toxicity associated with these nonmyeloablative regimens, from minimally cytopenic regimens that use low-dose total body irradiation alone<sup>12</sup> to regimens that combine fludarabine with melphalan or busulfan.<sup>10,13</sup> Although these studies have demonstrated impressive allogeneic engraftment with minimal nonhematologic toxicity, there is still significant morbidity and mortality from acute and chronic GVHD.<sup>8-11</sup>

We have therefore developed a novel nonmyeloablative regimen for allogeneic SCT. Our regimen was designed to suppress the recipient immune system enough to allow allogeneic engraftment without excessive regimen toxicity or GVHD. The use of fludarabine as an immunosuppressant as part of the conditioning regimen was similar to previously published studies of nonmyeloablative SCT.<sup>8-11</sup> However, the addition of *in vivo* CAMPATH-1H to the conditioning regimen was new and appears to have been crucial in limiting graft-vs.-host reactions.

## PATIENTS AND METHODS

### Eligibility Criteria

Patients with hematologic malignancies were enrolled at 6 hospitals in the United Kingdom. The study design was approved by the ethics committees at each participating site. All patients gave written informed consent to participate. Patients aged 18 to 60 years with lymphoma, acute leukemia, myelodysplasia, multiple myeloma, chronic lymphocytic leukemia, and chronic myeloid leukemia were eligible to participate. Patients required an HLA-identical sibling or unrelated donor as determined by serological typing for HLA-A/-B and molecular typing for HLA-DR/-DQ.

## Patient Characteristics

Twenty-five patients were enrolled in the study from June 1997 to September 1999. The patients had high-risk features including the following: all had a previous failed transplant and 6 had refractory disease. The median interval from first to second transplant was 24 months (range, 8 to 79 months).

## Conditioning Regimen

Treatment consisted of the humanized monoclonal antibody CAMPATH-1H 20 mg/day intravenous (IV) infusion over 8 hours on days -8 to -4, fludarabine 30 mg/m<sup>2</sup> IV infusion over 30 minutes on days -7 to -3, and melphalan 140 mg/m<sup>2</sup> IV infusion over 30 minutes on day -2. Seventeen recipients received unmanipulated peripheral blood stem cells from their siblings, and 8 received unmanipulated marrow from matched unrelated donors.

## Stem Cell and Bone Marrow Collection

Sibling donors received G-CSF at 10 µg/kg subcutaneously on days -4 to 0. Leukaphereses were performed on days 0 and 1 using conventional techniques for peripheral blood stem cell (PBSC) collection. Unrelated donors had bone marrow collected on day 0 under general anesthesia using conventional techniques. Unmanipulated mobilized peripheral blood (days 0 and 1) or bone marrow (day 0) cells were infused through central venous catheters.

## Supportive Care

Patients were managed in reverse isolation in conventional or laminar airflow rooms. All patients received prophylaxis with cotrimoxazole or pentamidine against *Pneumocystis carinii* infection. Acyclovir and fluconazole or itraconazole prophylaxis were routinely used. Blood products were irradiated to 25 Gy. Red cell and platelet transfusions were given to maintain hemoglobin >9 g/dL and platelet count >10–15 × 10<sup>9</sup>/L. Cytomegalovirus (CMV)-seronegative patients received only CMV-negative blood products; seropositive patients received blood products unscreened for CMV. Febrile neutropenic patients received broad-spectrum IV antibiotics according to each hospital's policy for the management of neutropenic sepsis. G-CSF 5 µg/kg per day subcutaneously was administered at the discretion of the transplant physician to speed hematologic recovery in patients until the patient's absolute neutrophil count (ANC) was at least 1000/µL for 3 consecutive days.

## GVHD Prophylaxis and Grading

GVHD prophylaxis consisted of CsA 3 mg/kg starting on day -1. IV CsA was switched to an oral dose as soon as the patients could tolerate medications by mouth and was continued for a median of 4 months (range, 1 to 8 months). Patients who survived 100 days or longer were evaluable for chronic GVHD. Acute and chronic GVHD were graded according to consensus criteria.<sup>14</sup>

### Study End Points

The primary study end points were successful durable hematopoietic engraftment and transplant-related mortality. There were secondary end points, including regimen-related toxicity, incidence and severity of GVHD, and progression-free survival.

## RESULTS

### Toxicities

All patients were assessable for toxicity. The conditioning regimen was generally well tolerated in patients who received only CsA as GVHD prophylaxis. There were no cases of veno-occlusive disease. Three patients died from regimen-related toxicity.

### Engraftment

One patient was not evaluable for engraftment because of death on day 21. All other patients had sustained engraftment as defined by ANC's  $>0.5 \times 10^9/L$  and untransfused platelet counts of  $>20 \times 10^9/L$  for at least 3 consecutive days. The median time to recover an ANC of  $0.5 \times 10^9/L$  was 13 days (range, 8–23 days) and  $>1.0 \times 10^9/L$ , 17 days (range, 8–47 days). The median time to achieve platelets  $>20 \times 10^9/L$  was 13 days (range, 3–96 days) and  $>50 \times 10^9/L$ , 17 days (range, 8–118 days).

### Graft-vs.-Host Disease

No grade III–IV acute GVHD was observed posttransplant. Two patients developed grade I GVHD of the skin. Only 1 patient developed chronic GVHD, limited to skin and liver involvement.

## DISCUSSION

Transplant-related mortality remains a major obstacle to successful allogeneic SCT. The introduction of nonmyeloablative purine analog conditioning regimens has facilitated allogeneic engraftment while limiting regimen-related mortality.<sup>8-11,13</sup> In spite of this, GVHD remains a significant cause of mortality and morbidity following nonmyeloablative conditioning. Previously published results of other nonmyeloablative conditioning regimens have shown a 38% to 60% incidence of grade II-IV acute GVHD.<sup>8-11,13</sup> This was the primary cause of death in some patients. In our study, the incidence of GVHD was exceptionally low. No patients had grade III-IV acute GVHD, and only 2 patients (5%) developed grade I acute GVHD. The incidence of chronic GVHD was also low, with only 1 patient developing limited skin involvement.

The use of this conditioning regimen has been relatively safe in a group of patients who had many high-risk features: prior high-dose therapy, renal or cardiac impairment, or high-risk diagnoses for allogeneic SCT such as Hodgkin's disease and multiple myeloma. Indeed, allogeneic transplant using myeloablative conditioning after failed autologous transplantation has been associated with a treatment mortality ranging between 50% and 80%.<sup>15,16</sup> Undoubtedly, such a high mortality rate may offset a potential for cure, and therefore, conventional transplants have generally been avoided in such patients. In our study, all patients received a second transplant, and only 3 patients died from transplant-related complications, demonstrating that this nonmyeloablative approach could be attempted if a second transplant has to be considered.

In summary, our results show that our nonmyeloablative regimen facilitates allogeneic engraftment with a low incidence of GVHD and TRM. The long-term antitumor activity of this regimen remains unknown; however, if used in combination with the prophylactic or preemptive use of DLI, prolonged remissions might be obtained in some types of hematologic malignancies.

## REFERENCES

1. Ringden O, Horowitz MM, Gale RP, et al. Outcome after allogeneic bone marrow transplant for leukemia in older adults. *JAMA* 270:57-60, 1993.
2. Klingemann HG, Storb R, Fefer A, et al. Bone marrow transplantation in patients aged 45 years and older. *Blood* 67:770-776, 1986.
3. Weiden PL, Flournoy N, Thomas ED, et al. Antileukemic effect of graft-versus-host disease in recipients of allogeneic-marrow grafts. *N Engl J Med* 300:1068-1073, 1979.
4. Kolb HJ, Mittermuller J, Clemm CH, et al. Donor leukocyte transfusions for treatment of recurrent chronic myelogenous leukemia in marrow transplant patients. *Blood* 76:2462-2465, 1990.
5. Mackinnon S, Papadopoulos EP, Carabasi MH, et al. Adoptive immunotherapy evaluat-

- ing escalating doses of donor leukocytes for relapse of chronic myeloid leukemia following bone marrow transplantation: separation of graft-versus-leukemia responses from graft-versus-host disease. *Blood* 86:1261–1268, 1995.
6. Bertz H, Burger JA, Kunzmann R, Mertelsmann R, Finke J. Adoptive immunotherapy for relapsed multiple myeloma after allogeneic bone marrow transplantation (BMT): evidence for a graft-versus-myeloma effect. *Leukemia* 11:281–283, 1997.
  7. Mandigers CM, Meijerink JP, Raemaekers JM, Schattenberg AV, Mensink EJ. Graft-versus-lymphoma effect of donor leucocyte infusion shown by real-time quantitative PCR analysis of t(14;18) [letter]. *Lancet* 352:1522–1523, 1998.
  8. Khouri IF, Keating M, Korbling M, et al. Transplant-lite: induction of graft-versus-malignancy using fludarabine-based nonablative chemotherapy and allogeneic blood progenitor-cell transplantation as treatment for lymphoid malignancies. *J Clin Oncol* 16:2817–2824, 1998.
  9. Giralt S, Estey E, Albitar M, et al. Engraftment of allogeneic hematopoietic progenitor cells with purine analog-containing chemotherapy: harnessing graft-versus-leukemia without myeloablative therapy. *Blood* 89:4531–4536, 1997.
  10. Slavin S, Nagler A, Naparstek E, et al. Nonmyeloablative stem cell transplantation and cell therapy as an alternative to conventional bone marrow transplantation with lethal cytoreduction for the treatment of malignant and nonmalignant hematologic diseases. *Blood* 91:756–763, 1998.
  11. Childs R, Clave E, Contentin N, et al. Engraftment kinetics after nonmyeloablative allogeneic peripheral blood stem cell transplantation: full donor T-cell chimerism precedes alloimmune responses. *Blood* 94:3234–3241, 1999.
  12. Storb R, Yu C, Sandmaier BM, et al. Mixed hematopoietic chimerism after marrow allografts: transplantation in the ambulatory care setting. *Ann N Y Acad Sci* 872:372–375, 1999.
  13. Giralt S, Weber D, Aleman A, et al. Non myeloablative conditioning with fludarabine/melphalan (FM) for patients with multiple myeloma (MM) [abstract]. *Blood* 94 (Suppl 1):347, 1999.
  14. Przepiorka D, Weisdorf D, Martin P, et al. 1994 Consensus Conference on Acute GVHD Grading. *Bone Marrow Transplant* 15:825–828, 1995.
  15. Tsai T, Goodman S, Saez R, et al. Allogeneic bone marrow transplantation in patients who relapse after autologous transplantation. *Bone Marrow Transplant* 20:859–863, 1997.
  16. Ringden O, Labopin M, Frassoni F, et al. Allogeneic bone marrow transplant or second autograft in patients with acute leukemia who relapse after an autograft. Acute Leukaemia Working Party of the European Group for Blood and Marrow Transplantation (EBMT). *Bone Marrow Transplant* 24:389–396, 1999.

# DNA Vaccination to Activate the Immune System Against Hematologic Malignancies

**T.J. Hamblin, J. Rice, C.A. King, S.S. Sahota,  
M.B. Spellerberg, F.K. Stevenson**

*Molecular Immunology Group, Tenovus Laboratory,  
Southampton University Hospitals, Southampton, UK*

## ABSTRACT

Immunotherapy is beginning to find a place in the treatment of hematologic malignancies. The intriguing effect of donor lymphocyte infusion in suppressing tumor growth in a transplant setting has indicated that an active immune attack on tumor cells can be successfully mounted. To extend this effect and apply it to other clinical situations, specific vaccines are being developed. DNA vaccines are vehicles that can deliver genes encoding tumor antigens to the immune response in a form that engages an appropriate immune response. Many tumor antigens are being revealed at the gene level, and they can be placed into a DNA plasmid with a strong promoter. Immunostimulatory sequences in the backbone bacterial DNA activate cytokine production to drive a T helper 1 ( $T_H1$ )-dominated response.

We have developed DNA vaccines that contain the  $V_H$  and  $V_L$  genes of the tumor immunoglobulin (Ig) assembled as single-chain Fv (scFv). To promote immunity, an alert sequence from the fragment C (FrC) of tetanus toxin (TT) has been fused to the scFv. The fusion gene induces strong anti-idiotypic protection against lymphoma in models and is now in clinical trials for patients with low-grade lymphoma. The same design appears to protect against myeloma via a T-cell-mediated attack. A clinical trial of patients with myeloma postautograft is planned.

The knowledge of new candidate tumor antigens coupled with the relative ease of manipulation of DNA vaccine design is offering opportunities for immune attack on cancer. However, the clinical setting is critical, and small clinical trials will be needed to optimize efficacy of these vaccines.

## INTRODUCTION

Vaccination against infectious diseases began more than 200 years ago and has been remarkably successful. Smallpox has been eliminated. The morbidity and mortality of polio, measles, rubella, diphtheria, and hepatitis B have been

massively reduced. Vaccination against cancer is a more recent development. Some tumors are consequent on infection and may be prevented by immunizing against the infective agent. The reduction in hepatoma following hepatitis B vaccination in Taiwan illustrates the potential of the approach.<sup>1</sup>

For the majority of tumors, however, it will be necessary to immunize a patient who has already developed a tumor. This tumor may have “sneaked” under any immune surveillance or may differ from normal tissue only in ways that fail to interest the immune system. Furthermore, the presence of the tumor may exert an immunosuppressive effect on the patient that may be compounded by cytotoxic treatment. The challenge to immunologists is to identify targets for immunotherapy and develop strategies to maximize the immune response. One of the hoped-for consequences of the completion of the Human Genome Project will be the identification of a large number of tumor-specific antigens capable of inducing an immune attack.

Recently, DNA vaccines have been developed and used with success in murine models to protect against infectious diseases.<sup>2</sup> In addition, a DNA vaccine against heat shock protein has been reported to cure mice chronically infected with *Mycobacterium tuberculosis*.<sup>3</sup> Clinical trials of DNA vaccines against human immunodeficiency virus and malaria are currently established.<sup>4,5</sup>

## DNA VACCINES

Wolff et al.<sup>6</sup> made the surprising observation that naked plasmid DNA containing a gene encoding the enzyme  $\beta$ -galactosidase, when injected intramuscularly, generated the production of functional enzyme. Subsequently, Ulmer et al.<sup>2</sup> found that DNA encoding nucleoprotein from influenza virus induced antibody and T-cell responses and protective immunity against a viral challenge.

DNA vaccines constitute a backbone of circular bacterial DNA into which a variety of mammalian genes may be ligated—not only putative immune targets under appropriate promoters, but also genes controlling adjunctive functions of the immune system, including a wide variety of cytokine genes. The net effect is to give great flexibility in manipulating the immune response.

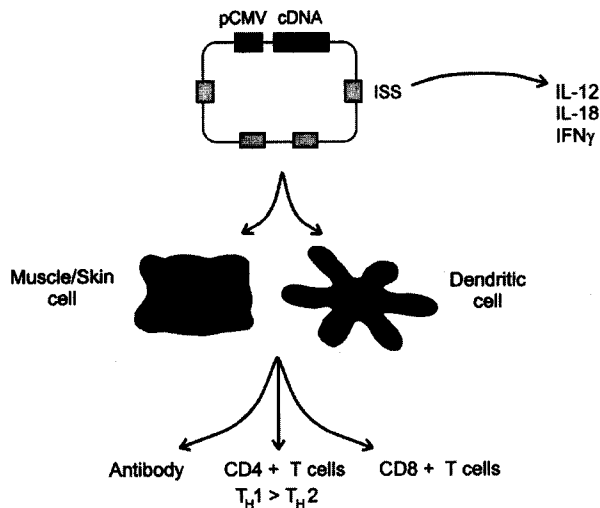
Bacterial DNA contains immunostimulatory sequences (ISSs) not found in mammalian DNA. These ISSs contain unmethylated CpG dinucleotide repeats with appropriate surrounding motifs. The effect of these sequences is to activate the innate immune system via induction of interferon (IFN)- $\gamma$ , IFN- $\alpha$ , interleukin (IL)-12, and IL-18 and to direct the immune response down a  $T_H1$ -dominated pathway.<sup>7,8</sup> DNA plasmids, therefore, have 2 components: a transcriptional unit driven by a powerful cytomegalovirus (CMV) promoter and able to direct the synthesis of the tumor antigenic protein and an ISS able to direct the nature of the immune response.



When the vaccine is injected intramuscularly, the long-lived muscle cells act as a depot of antigen and release soluble antigen for uptake by antigen-presenting cells (APCs).<sup>9</sup> A small number of dendritic cells may also be directly transfected.<sup>10</sup> Induction of cytotoxic T lymphocytes appears to occur by cross-priming, a process whereby antigen is delivered to APCs either in membrane form or via heat shock proteins (Figure 1).<sup>11,12</sup>

### DNA VACCINES AGAINST IDIOTYPE

Idiotypic (Id) determinants of the clonal Ig of B-cell tumors are clear-cut tumor-specific antigens.<sup>13</sup> Ig genes are derived from recombinatorial events involving V, D, and J segment genes. Imprecision in joining, resulting in gain or loss of nucleotides at the junctions, provides for unique sequences at the complementarity-determining region 3 loop, and further sequence diversity is generated by somatic mutation during the course of lymphocyte maturation. Neoplastic transformation preserves the unique V-region sequence in the proliferating clone, so that Id can be considered tumor specific and an ideal target for immunotherapy.

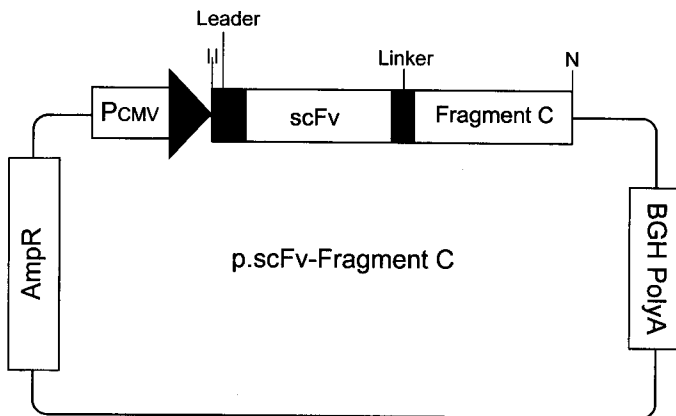


**Figure 1.** Following injection of DNA vaccines (which contain the cDNA transcriptional unit encoding the antigen, driven by a cytomegalovirus promoter [pCMV], and immunostimulatory sequences (ISS) of unmethylated CpG dinucleotide repeats, which stimulate the production of cytokines) there is either direct transfection of antigen-presenting cells or the creation of an antigen depot in muscle cells (or keratinocytes if the injection is intradermal. IFN, interferon; IL, interleukin;  $T_H$ , T helper.

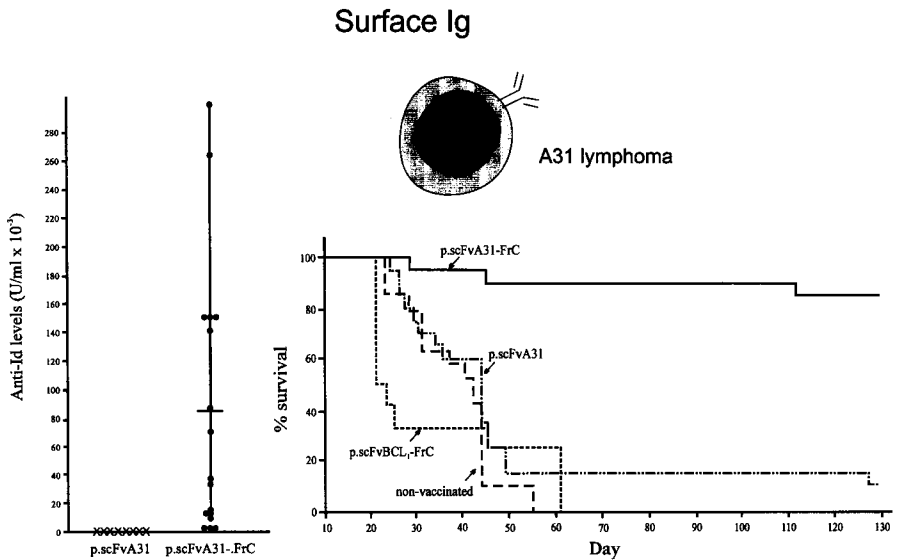
In B-cell lymphomas, Id Ig is capable of inducing protective anti-Id immunity in mice, especially when conjugated to keyhole limpet hemocyanin with adjuvant or cytokines as activators.<sup>14-16</sup> A small clinical trial is showing promising results,<sup>17</sup> but the logistic difficulty of producing bespoke vaccines and the opportunity to use additional immune pathways drove us to explore a molecular route for vaccine preparation.

It is relatively simple to obtain Id-encoding  $V_H$  and  $V_L$  genes from tumor biopsies by polymerase chain reaction cloning and sequencing. We chose to assemble the genes as scFv with a 15-amino acid peptide linker.<sup>18</sup> These were ligated into a plasmid with a CMV promoter. Unfortunately, such a vaccine produces only erratically low levels of anti-Id antibody and no protection against tumor challenge. Similarly weak responses were reported when DNA encoding whole Ig was encoded, although stronger responses could be produced if the Ig constant regions were xenogeneic.<sup>19</sup>

Our approach to enhancing the immune response was to fuse a gene encoding highly immunogenic protein from a pathogen to the 3' end of scFv. We chose the FrC of TT, a nontoxic COOH-terminal polypeptide of 50 kDa (Figure 2). This sequence had been previously shown to induce protective immunity to *Clostridium tetani* when delivered as a DNA vaccine. In mice, fusing FrC in this way strikingly amplified the antibody response against 4 human scFv sequences.<sup>20</sup> The responses included anti-Id antibody, which is consistent with proper folding of the scFv. Anti-Id could not be generated unless the genes were



**Figure 2.** The plasmid is derived from pcDNA3 and contains the cytomegalovirus (CMV) immediate/early promoter with the bovine growth hormone (BGH) poly(A) site. The single-chain Fv (scFv) is assembled with its leader sequence and fused to fragment C of tetanus toxin via a GPGP peptide linker. The markers are HindIII and NotI restriction enzyme sites.

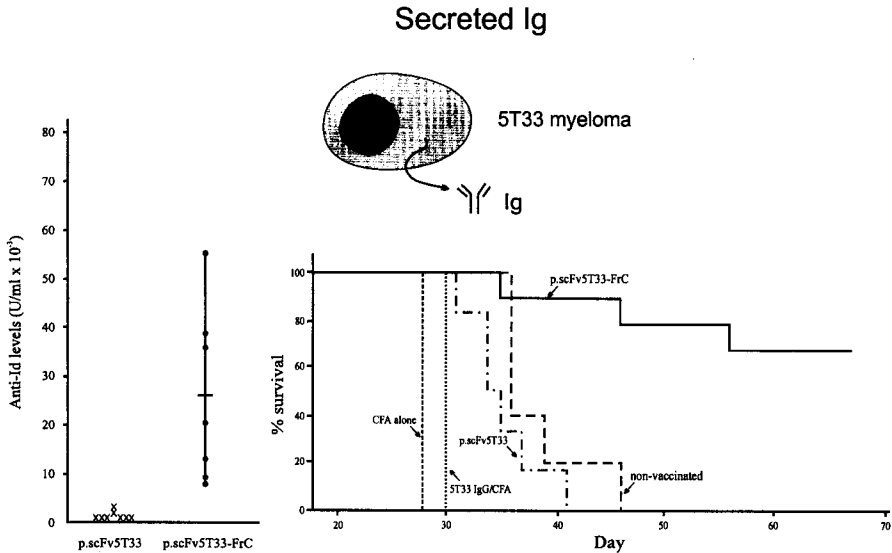


**Figure 3.** The single-chain Fv/fragment C (scFv-FrC) DNA fusion vaccine promotes anti-idiotypic (anti-Id) antibody and protective immunity against the surface immunoglobulin (Ig)-positive A31 lymphoma. Controls of scFv alone or an irrelevant scFV fused to FrC were ineffective.

fused within the plasmid. This indicates that CD4<sup>+</sup> T cells specific for FrC are acting as helper cells for B cells producing anti-Id in a manner similar to a cognate hapten-carrier effect.<sup>21</sup>

To test the performance of this vaccine in protecting against lymphoma, we used a mouse model of B-cell lymphoma, A31.<sup>22</sup> The fusion vaccine induced anti-Id antibodies in syngeneic mice and conferred protection against tumor cell challenge. Neither DNA scFv alone nor a control fusion gene from a different lymphoma conferred protection. From our previous studies using Id protein vaccination, we believe that protection against this tumor is antibody mediated (Figure 3).

We also tested a similar vaccine in a myeloma model. 5T33 resembles human myeloma in secreting high levels of IgG paraprotein, producing osteolytic lesions, and lacking surface Ig. Because of this, the antibody is unlikely to mediate protection. In fact, vaccination with Id protein in complete Freund's adjuvant (CFA) completely failed to protect against tumor challenge. In contrast, vaccination with DNA scFv-FrC induced protection against tumor challenge, apparently mediated by T cells. Anti-Id antibodies were generated and were useful for monitoring, although



**Figure 4.** The single-chain Fv/fragment C (scFv-FrC) DNA fusion vaccine promotes anti-idiotypic (anti-Id) antibody and protective immunity against the surface immunoglobulin (Ig)-negative, Ig-secreting 5T33 myeloma. A control of scFv alone was ineffective. Injection of 5T33 IgG Id protein with complete Freund's adjuvant (CFA) generated high levels of anti-Id antibody (not shown) but no protective immunity.

they were not protective. As for the lymphoma model, DNA scFv alone was ineffective (Figure 4).<sup>22</sup>

The success of the FrC fusion product should not seem too remarkable. The immune system is not set up to recognize self-antigens such as idiotype; rather, it is constructed to defend against pathogens. To interest APCs in this antigen, an alert or danger signal is necessary. The pathogen-derived FrC was in this respect a fortunate choice, though plainly not the only possible one. One concern about the use of FrC as a promotional sequence was the possibility that preexisting immunity against TT (which is present in most individuals) would interfere with the capture of the fusion protein by Id-specific B cells and abrogate the desired anti-Id response. This phenomenon of epitope suppression has been described for peptides coupled to TT.

To investigate, we preimmunized mice with TT and then measured subsequent anti-Id responses to the DNA scFv-FrC vaccine. We found that even in the presence of very high levels of anti-FrC, there was no suppression of the protection against both A31 and 5T33.<sup>22</sup>

## ALTERNATIVE TUMOR ANTIGENS

Apart from idiotypic Ig on B-cell tumors, similar recombinatorial sequences produce the T-cell receptor, a target for T-cell tumors. Other glycoproteins include the mucin family. These heavily glycosylated macromolecules undergo aberrant glycosylation in some tumors, revealing hidden determinants on the core protein backbone that can function as tumor-specific antigens. At least one of these, MUC-1, can be detected on myeloma cells as well as on epithelial cancers.<sup>23</sup>

The DNA FrC fusion gene approach may well be effective in a number of these areas. In preliminary unpublished experiments, we have demonstrated enhanced responses for carcino embryonic antigen and MUC-1 vaccines.

## CLINICAL TRIALS OF DNA VACCINES IN HEMATOLOGIC PATIENTS

Although it is difficult to envisage toxic side effects for DNA scFv-FrC vaccines, we have carried out a small trial of intramuscular injection of DNA scFv alone in 7 patients with end-stage low-grade non-Hodgkin's lymphoma.<sup>24</sup> There were no adverse side effects, but as expected in this heavily pretreated group with stage IV disease, no immune responses. This safe profile accords with the results of DNA vaccine trials in infectious diseases, which are now being carried out in normal individuals.<sup>25,26</sup> The fears of integration into the genome or pathological anti-DNA antibodies have not materialized, reflecting the fact that bacterial DNA is harmlessly liberated during infections.

We are currently using the scFv-FrC vaccine in a dose escalation study of patients with stage III or IV or bulky stage II follicular lymphoma in complete remission. This phase 2 study admits patients who have been in complete remission for at least 3 months following treatment with any chemo- or radiotherapy other than purine analogs or high-dose plus autograft. Patients must have fresh or fresh frozen tumor tissue from which to extract RNA or DNA and must be willing to undertake barrier contraception for a year after vaccination. All gene therapy patients must agree that their case records and those of any children born after the therapy be monitored by the Department of Health until death.

The primary end points will be the generation of immune responses against Id and tetanus. The secondary end point will be elimination of minimal residual disease.

Antibodies to TT and Id will be detected by enzyme-linked immunosorbent assay (ELISA), coating the wells with recombinant FrC and tumor-derived Fab, respectively. Detection of IgG anti-Id responses will be with horseradish peroxidase-conjugated anti- $\gamma$ . Specificity will be controlled using Fab obtained from a different patient or from normal Ig.

Proliferative T-cell responses will be measured before and after vaccination using mononuclear cells cultured in the presence of the idiotypic Ig or control Id

Ig. Responses to recombinant FrC protein will also be measured. Production of cytokines including IFN- $\gamma$ , GM-CSF, and tumor necrosis factor (TNF)- $\alpha$  by responding T cells will be measured by ELISA. The contribution of CD4<sup>+</sup> or CD8<sup>+</sup> T cells to cytokine release will be assessed by the effects of adding monoclonal antibodies against major histocompatibility complex (MHC) class I or II antigens to the wells or by purifying T-cell subsets by negative selection. The ability to respond to whole tumor cells will be measured, with purified B cells as a control. CD4<sup>+</sup> T-cell lines will be cultured using repeated stimulation with Id Ig irradiated autologous feeder cells and IL-2.

Cytotoxic T-cell activity will be measured using autologous myeloma cells as targets where it is possible to achieve sufficient uptake of radiolabel. As an alternative, radiolabeled autologous fibroblasts transfected with scFv or FrC will be used. Transfection will be by using adenoviral or retroviral gene transfer. Stimulation *in vitro* will be with autologous dendritic cells either loaded or transfected with Id Ig/FrC. CD8<sup>+</sup> cell lines will be cultured using repeated stimulation with dendritic cells/antigen and IL-2. Cytokine release by negatively selected CD8<sup>+</sup> T cells will also be investigated.

Five patients will be vaccinated with 6 injections of 500  $\mu$ g DNA on weeks 0, 1, 2, 4, 8, and 12. Dose escalations will be in 500- $\mu$ g increments every 5 patients. If all 5 patients achieve an immune response, then a further 20 patients will be vaccinated at that dose and the next higher dose. Between 25 and 65 patients will be required for the trial. Twenty-five have so far been recruited, and 2 vaccinated. The first has produced an immune response to tetanus.

We now have ethics committee and Gene Therapy Advisory Committee approval for the use of this vaccination strategy in chronic lymphocytic leukemia (CLL) and multiple myeloma. In CLL, we are aware of the poor immune function and have selected early stage A patients whose unmutated Ig V genes imply a poor prognosis.<sup>27</sup> In myeloma, we do not believe immune deficiency to be a problem, since these patients easily produce human anti-mouse antibody (HAMA) responses when treated with monoclonal antibodies. We have chosen to vaccinate patients at maximum response following stem cell autograft.

We also have approval to vaccinate transplant donors. There was some ethical debate about this, but donor vaccination has a long and honorable tradition in blood transfusion, and DNA vaccination in volunteers has already begun for infectious diseases. In myeloma, vaccination using the myeloma protein has been performed without apparent hazard. Intrinsically, DNA vaccination is less hazardous than protein vaccination, since there is no risk of viral transmission. The Ig genes within the plasmid are unrelated to the cause of the tumor and carry no risk of transmitting it, even to a close relative.

We intend to vaccinate the donors of stem cells to myeloma patients receiving conventional or nonmyeloablative allografts who have resistant or relapsed disease.

After vaccination, donors will provide educated donor lymphocytes to generate a graft-vs.-myeloma effect without graft-vs.-host disease.

### ACKNOWLEDGMENTS

We gratefully acknowledge support from Tenovus UK, Leukaemia Research Fund, Cancer Research Campaign, and the Multiple Myeloma Research Foundation.

### REFERENCES

1. Chang MH, Chen CJ, Lai MS, et al. Universal hepatitis B vaccination in Taiwan and the incidence of hepatocellular carcinoma in children. Childhood Hepatoma Study Group. *N Engl J Med* 336:1855–1859, 1997.
2. Ulmer JB, Donnelly JJ, Parker SE, et al. Heterologous protection against influenza by injection of DNA encoding a viral protein. *Science* 259:1745–1749, 1993.
3. Lowrie DB, Tascon RE, Bonato VL, et al. Therapy of tuberculosis in mice by DNA vaccination. *Nature* 400:269–271, 1999.
4. Wang R, Doolan DL, Le TP, et al. Induction of antigen-specific cytotoxic T lymphocytes in humans by a malaria DNA vaccine. *Science* 282:476–480, 1998.
5. Boyer JD, Chattergoon MA, Ugen KE, et al. Enhancement of cellular response in HIV-1 seropositive individuals: a DNA-based trial. *Clin Immunol* 90:100–107, 1999.
6. Wolff JA, Malone RW, Williams P, et al. Direct gene transfer into mouse muscle in vivo. *Science* 247:1465–1468, 1990.
7. Klinman DM, Yi A, Beaucage SL, Conover J, Krieg AM. CpG motifs expressed by bacterial DNA rapidly induce lymphocytes to secrete IL-6, IL-12 and IFN $\gamma$ . *Proc Natl Acad Sci U S A* 93:2879–2883, 1996.
8. Sato Y, Roman M, Tighe H, et al. Non-coding bacterial DNA sequences necessary for effective intradermal gene immunization. *Science* 273:352–354, 1996.
9. Davis HL, Millan CL, Watkins SC. Immune mediated destruction of transfected muscle fibres after direct gene transfer with antigen-expressing plasmid DNA. *Gene Ther* 4:181–188, 1997.
10. Casares S, Inaba K, Brumeanu TD, Steinman RM, Bona CA. Antigen presentation by dendritic cells after immunization with DNA encoding a major histocompatibility complex class II-restricted viral epitope. *J Exp Med* 186:1481–1486, 1997.
11. Carbone FR, Bevan MJ. Class-I restricted processing of exogenous cell associated antigen in vivo. *J Exp Med* 171:377–387, 1990.
12. Suto R, Sristava PK. A mechanism for the specific immunogenicity of heat shock protein-chaperoned peptides. *Science* 269:1585–1588, 1995.
13. George AJT, Stevenson FK. Prospects for the treatment of B cell tumors using idiotypic vaccination. *Intern Rev Immunol* 4:271–310, 1989.
14. George AJT, Tutt AL, Stevenson FK. Anti-idiotypic mechanisms involved in the suppression of a mouse B-cell lymphoma, BCL $_1$ . *J Immunol* 138:628–634, 1987.
15. Kaminski MS, Kitamura K, Maloney DG, Levy R. Idiotypic vaccination against a murine

- B-cell lymphoma: inhibition of tumor immunity by free idiotypic protein. *J Immunol* 138:1289–1296, 1987.
16. Chen TT, Tao M-H, Levy R. Idiotype-cytokine fusion proteins as cancer vaccines: relative efficiency of IL-2, IL-4 and GM-CSF. *J Immunol* 153:4775–4787, 1994.
  17. Hsu F, Caspar CB, Czerwinski D, et al. Tumor-specific idiotype vaccines in the treatment of patients with B-cell lymphoma: long term results of a clinical trial. *Blood* 89:3129–3135, 1997.
  18. Hawkins RE, Zhu D, Ovecka M, et al. Idiotypic vaccination against human B-cell lymphoma: rescue of variable region gene sequences from biopsy material for assembly as single chain Fv “personal” vaccines. *Blood* 83:3279–3288, 1994.
  19. Syrenglas AD, Chen TT, Levy R. DNA immunization induces protective immunity against B-cell lymphoma. *Nature Med* 2:1038–1041, 1996.
  20. Anderson R, Gao X-M, Papakonstantinou A, Roberts M, Dougan G. Immune response in mice following immunization with DNA encoding fragment C of tetanus toxin. *Infect Immunol* 64:3168–3173, 1996.
  21. Spellerberg MB, Zhu D, Thompsett A, King CA, Hamblin TJ, Stevenson FK. DNA vaccines against lymphoma: promotion of anti-idiotypic antibody responses induced by single chain Fv genes by fusion to tetanus toxin fragment C. *J Immunol* 159:1885–1892, 1997.
  22. King CA, Spellerberg MB, Zhu D, et al. DNA vaccines with single chain Fv fused to fragment C of tetanus toxin induce protective immunity against lymphoma and myeloma. *Nature Med* 4:1281–1286, 1998.
  23. Takahashi T, Makigushi Y, Hinoda Y, et al. Expression of MUC1 on myeloma cells and induction of HLA unrestricted CTL against MUC1 from a multiple myeloma patient. *J Immunol* 153:2102–2109, 1994.
  24. Hawkins RE, Russell SJ, Stevenson F, Hamblin T. A pilot study of idiotypic vaccination for follicular B-cell lymphoma using a genetic approach. CRC NO:92/33. Protocol NO: PH1/027. *Hum Gene Ther* 8:1287–1299, 1997.
  25. Kumar A, Arorer R, Kaur P, Chauhan VS, Sharma P. Universal T helper cell determinants enhance immunogenicity of *Plasmodium falciparum* merozoite surface antigen peptide. *J Immunol* 148:1499–1505, 1992.
  26. Davis HL, Millan CL, Mancini M, et al. DNA-based immunization against hepatitis-B surface antigen (HbsAg) in normal and HbsAg-transgenic mice. *Vaccine* 15:849–852, 1997.
  27. Hamblin TJ, Davis Z, Gardiner A, Oscier DG, Stevenson FK. Unmutated immunoglobulin VH genes are associated with a more aggressive form of chronic lymphocytic leukemia. *Blood* 94:1848–1854, 1999.



# **Yttrium-90 Zevalin Radioimmunotherapy for Patients With Relapsed B-Cell Non-Hodgkin's Lymphoma (IDEC-Y2B8)**

**Thomas E. Witzig**

*Division of Internal Medicine and Hematology, Mayo Clinic  
and Mayo Foundation, Rochester, Minnesota*

## **ABSTRACT**

The CD20 antigen is expressed on the majority of cases of non-Hodgkin's lymphoma (NHL) and is not expressed on other normal tissue cells, making CD20 a suitable target for immunotherapy of NHL. Rituximab is a monoclonal antibody that has been extensively tested over the past few years and has been demonstrated to be clinically useful in patients with relapsed CD20<sup>+</sup> NHL with an overall response rate (ORR) of ~50% and a time to progression (TTP) of ~1 year. Ibritumomab is the murine parent anti-CD20 antibody that was engineered to make rituximab. Tiuxetan is a MX-DTPA linker chelator that is attached to ibritumomab to form Zevalin (ibritumomab tiuxetan). Zevalin can react with indium-111 (<sup>111</sup>In) or yttrium-90 (<sup>90</sup>Y) to form <sup>111</sup>In-Zevalin, which is used for dosimetry, or <sup>90</sup>Y-Zevalin, which is used for therapy of B-cell NHL. A multicenter phase 1/2 clinical trial (*J Clin Oncol* 17:3793–3803, 1999) was performed that tested single doses of 0.2, 0.3, or 0.4 mCi/kg (maximum 32 mCi) <sup>90</sup>Y-Zevalin; it was found that 0.4 mCi/kg was the maximum tolerated dose (MTD) in patients with a baseline platelet count  $\geq 150,000$ , 0.3 mCi/kg in patients with a baseline platelet count of 100,000–149,000/ $\mu$ L. Prophylactic growth factors or stem cells were not used. Tumor responses were demonstrated in 67% of all patients and 82% with low-grade NHL. The phase 1/2 trial was followed by a phase 3 trial that randomized 143 eligible patients to either rituximab or the <sup>90</sup>Y-Zevalin radioimmunoconjugate. The specific aim of this trial was to demonstrate that the addition of the <sup>90</sup>Y radioisotope to the murine anti-CD20 antibody (ibritumomab) provided additional efficacy over the unconjugated (cold) human chimeric anti-CD20 antibody (rituximab) alone. A planned interim analysis of the first 90 patients demonstrated an ORR of 80% with <sup>90</sup>Y-Zevalin vs. 44% for rituximab ( $P < .05$ ). To provide additional evidence of the benefit of <sup>90</sup>Y radioimmunotherapy over immunotherapy, an additional trial enrolled patients who were nonresponsive or

refractory to rituximab and treated them with 0.4 mCi/kg  $^{90}\text{Y}$ -Zevalin. An ORR of 46% was found in these rituximab-refractory patients; these data provide further evidence of the added value of  $^{90}\text{Y}$ .

### $^{90}\text{Y}$ -ZEVALIN RADIOIMMUNOTHERAPY

The CD20 antigen is expressed on nearly all B-cell NHL, making it a suitable target for immunotherapy. Rituximab (Rituxan from IDEC Pharmaceuticals, San Diego, CA; MabThera from Genentech, South San Francisco, CA) is a chimeric monoclonal antibody that reacts with the CD20 cell surface antigen. Rituximab was the first monoclonal antibody approved by the US Food and Drug Administration (USFDA) for use in treating a malignancy and the first such drug to be approved for NHL. The mechanism of rituximab's ability to produce remissions is not entirely clear, but *in vitro* experiments have demonstrated induction of apoptosis in target cells and antibody-dependent cellular cytotoxicity.<sup>1</sup> The largest clinical trial to date studied rituximab use in 166 patients with relapsed B-cell NHL and found an ORR of 48% with 6% complete remission (CR) and a 13-month TTP.<sup>2</sup>

Efforts to improve the treatment have led to studies combining immunotherapy with chemotherapy. This combination is feasible because rituximab usually does not suppress the bone marrow.<sup>3</sup> There are several large cooperative group trials currently under way that address the efficacy of chemotherapy plus rituximab in newly diagnosed or relapsed NHL.

Another method of improving the efficacy of monoclonal antibodies is to use the antibody to target radiation to the tumor cell. The most commonly used radionuclides linked to murine monoclonal antibodies are  $^{131}\text{I}$ ,  $^{90}\text{Y}$ , and  $^{67}\text{Cu}$ .<sup>4-6</sup> In radioimmunotherapy (RIT), the monoclonal antibody is used to focus the radiation on the target cell population while sparing the effects of radiotherapy on nearby

**Table 1.** Recently Completed Clinical Trials of  $^{90}\text{Y}$ -Zevalin\*

<i>Trial Number</i>	<i>Phase</i>	<i>Reference</i>	<i>Goal</i>
IDEC 106-03	1/2	12	<ul style="list-style-type: none"> <li>• Determine dose of rituximab before <math>^{111}\text{In}</math>-Zevalin</li> <li>• Determine MTD of <math>^{90}\text{Y}</math>-Zevalin</li> </ul>
IDEC 106-04	3	13, 18	<ul style="list-style-type: none"> <li>• Randomized trial of rituximab vs. <math>^{90}\text{Y}</math>-Zevalin to determine if efficacy of <math>^{90}\text{Y}</math>-Zevalin is superior</li> </ul>
IDEC 106-05	2	14	<ul style="list-style-type: none"> <li>• Efficacy and toxicity of 0.3 mCi/kg <math>^{90}\text{Y}</math>-Zevalin for patients with platelet count of 100,000–149,000/<math>\mu\text{L}</math></li> </ul>
IDEC 106-06	2	15	<ul style="list-style-type: none"> <li>• Efficacy and toxicity of 0.4 mCi/kg <math>^{90}\text{Y}</math>-Zevalin for patients refractory to rituximab</li> </ul>

\* $^{90}\text{Y}$ , yttrium-90;  $^{111}\text{In}$ , indium-111; MTD, maximum tolerated dose.

normal tissue. Recent studies of RIT have indeed demonstrated tumor regressions in patients with NHL, with very few side effects in normal organs other than myelosuppression due to radiation to the bone marrow.<sup>4,5,7-12</sup>

Ibritumomab is the murine monoclonal antibody that was engineered to form the chimeric antibody rituximab. Tiuxetan is a MX-DTPA linker chelator that is attached to ibritumomab to form Zevalin (ibritumomab tiuxetan). Zevalin is subsequently reacted with <sup>111</sup>In or <sup>90</sup>Y to form <sup>111</sup>In-Zevalin, which is used for dosimetry, or <sup>90</sup>Y-Zevalin, which is used for therapy. There have been 4 recently completed trials of <sup>90</sup>Y-Zevalin (Table 1).<sup>12-15</sup> In each study, the complete <sup>90</sup>Y-Zevalin radioimmunotherapy program was delivered over an 8-day period on an outpatient basis. On day 0, the patient received a dose of 250 mg/m<sup>2</sup> rituximab followed by 5.5 mCi <sup>111</sup>In-Zevalin. Between days 0 and 6, whole body scans were performed to predict the amount of radiation the tumor and normal organs would receive when <sup>90</sup>Y-Zevalin was administered. The study protocols allowed the <sup>90</sup>Y-Zevalin to be given on day 7 if the predicted dose to normal organs was <2000 cGy and <300 cGy to the bone marrow. The indium images also provided evidence that the radioimmunoconjugate was targeting the known tumor sites. The dosimetry results are summarized elsewhere.<sup>16,17</sup>

The initial study performed was a phase 1/2 trial of <sup>90</sup>Y-Zevalin that aimed to learn the dose of rituximab necessary for optimal <sup>111</sup>In-Zevalin dosimetry and to establish the maximum tolerated dose of <sup>90</sup>Y-Zevalin that could be given to patients without the use of stem cells or prophylactic growth factors.<sup>12</sup> Rituximab was given before each dose of Zevalin to bind to nonspecific CD20 antigenic sites and to deplete normal blood B cells; therefore, the infused Zevalin was more likely to bind to CD20 sites on the malignant cells. The phase 1 trial found that 250 mg/m<sup>2</sup> was the optimal dose of rituximab to be used before <sup>111</sup>In-Zevalin imaging and <sup>90</sup>Y-Zevalin therapy. Dosimetry predicted that all patients were eligible for <sup>90</sup>Y-Zevalin; ie, all normal organs were predicted to receive <2000 Gy and the bone marrow <300 cGy. The median age was 60 years, and 24% of patients were >70 years of age. Sixty-six percent of patients had low-grade histology, 28%

**Table 2.** Overall Response Rates to <sup>90</sup>Y-Zevalin for Patients in the Phase 1/2 Trial (IDEC 106-03)\*

<i>Histology</i>	<i>n</i>	<i>Overall Response, %</i>	<i>Complete Remission, %</i>	<i>Partial Remission, %</i>
All patients	51	67	26	41
Low grade	34	82	26	56
Intermediate	14	43	29	14
Mantle cell lymphoma	3	0	0	0

\*From Witzig et al.<sup>12</sup> Includes all patients treated at 0.2, 0.3, and 0.4 mCi/kg.

**Table 3.** Response to Therapy From the Interim Analysis of the First 90 Patients Accrued in the Randomized Trial of  $^{90}\text{Y}$ -Zevalin vs. Rituximab (IDEC Trial 106-04)\*

	<i>Rituximab</i>	<i>Zevalin</i>	<i>P</i>
Overall response rate, % (95% CI)	44 (28.1–58.9)	80 (64.2–89.7)	<.001
Complete response, %	7	21	.06
Partial response, %	37	59	

\*From Witzig et al.<sup>13</sup> CI, confidence interval.

intermediate grade histology, and 6% had mantle cell lymphoma. In the low-grade group, 6% had diffuse small lymphocytic, 27% follicular small cleaved, and 33% follicular mixed lymphoma. All patients had had prior chemotherapy (median of 2 prior regimens), and 92% had received an anthracycline. Thirty-seven percent had received prior external-beam radiotherapy; 27% had  $\geq 2$  extranodal sites of disease; 59% had bulky disease (defined as a mass  $\geq 5$  cm), and 43% had positive bone marrow. Five patients received 0.2, 15 received 0.3 mCi/kg, and 30 received 0.4 mCi/kg  $^{90}\text{Y}$ -Zevalin in the phase 1/2 trial. We found that 0.4 mCi/kg was the maximum tolerated single dose that could be delivered without the use of stem cells or prophylactic growth factors. The efficacy portion of the phase 1/2 trial (Table 2) demonstrated a 67% ORR in all patients, with 26% CR. In patients with low-grade NHL, the response rate was even higher at 82%, 26% CR.<sup>12</sup> The median time to progression for responders was 15.4 months.

The phase 1/2 trial<sup>12</sup> suggested that  $^{90}\text{Y}$ -Zevalin had a higher ORR than that found for rituximab<sup>2</sup>; therefore, it was necessary to confirm this important finding in a prospective randomized trial of  $^{90}\text{Y}$ -Zevalin vs. rituximab. Patients with relapsed CD20<sup>+</sup> NHL were randomized to receive either 0.4 mCi/kg (maximum of 32 mCi) Zevalin or rituximab 375 mg/kg per week  $\times 4$ .<sup>13</sup> Patients were eligible for this trial if they had a biopsy-proven low-grade, follicular, or transformed NHL, a performance status of 0–2, an absolute neutrophil count of  $\geq 1500 \times 10^6/\text{L}$ , and a platelet count  $\geq 150,000/\mu\text{L}$ . Pretreatment bone marrow was required to have <25% of the marrow cellularity occupied by NHL. Any prior external-beam radiation therapy had to have included <25% of the bone marrow. The patients could not have received prior anti-CD20 antibodies, recent colony-stimulating factors, or high-dose chemotherapy. They were also ineligible if they had human anti-mouse or anti-chimeric antibody (HAMA/HACA) or  $\geq 5000$  tumor cells in the blood. Patients with NHL related to the acquired immunodeficiency syndrome (AIDS) virus or those with chronic lymphocytic leukemia or central nervous system NHL were also ineligible.

One-hundred forty-three patients were randomized in IDEC 106-04, and the trial was closed in August 1999 after reaching its accrual goals. A planned single

**Table 4.** Bone Marrow Toxicity Experienced by Patients in 4 Clinical Trials of IDEC-Y2B8\*

Study Number	Reference	Absolute Neutrophil Count			Platelet Count		
		Nadir, $\times 10^6/L$	Grade 4 %†	Median Duration, d	Nadir, $/\mu L$	Grade 4 %‡	Median, Duration, d
103	12	1100	27	10.5	49,500	10	14
104	13	900	25	14	42,000	6	12
105	20	600	25	NA	34,000	15	NA
106	15	900	23	14	34,000	8	15

\*NA, not available; †grade 4 neutropenia is  $<500 \times 10^6/L$ ; ‡grade 4 thrombocytopenia is  $<10,000/\mu L$ .

interim analysis was performed after 90 patients were enrolled and treated, and the results are available on this group.<sup>13</sup> The patients were stratified by key clinicopathologic features so that the treatment arms were balanced. The interim analysis found an ORR of 80% with <sup>90</sup>Y-Zevalin compared with 44% for rituximab ( $P < .05$ ). The CR rate of 21% in the <sup>90</sup>Y-Zevalin arm was also higher than the 7% found with rituximab ( $P = .06$ ) (Table 3). Additional data from the other 53 patients and longer follow-up is necessary to determine if there are any differences between the treatment arms in TTP or overall survival. Although there were small numbers of patients in the diffuse small lymphocytic histologic group, the response to Zevalin was superior at 80% vs. 17% with rituximab. In addition, the ORR to Zevalin in the group of patients who were chemotherapy resistant was 77% compared with 32% with rituximab.<sup>18</sup>

In this trial, <sup>111</sup>In-Zevalin was used for dosimetry in patients randomized to Zevalin. An additional goal of the study was to learn if this complex dosimetry was necessary for routine clinical use. In this trial, the biodistribution and dosimetry were acceptable in all cases; therefore, no patient was unable to be treated with a therapeutic dose of Zevalin. The calculated Zevalin half-lives and bone marrow dosimetry-estimated absorbed radiation doses did not correlate with hematologic toxicity. Patient tolerance to both Zevalin and rituximab was excellent, and there were no significant major organ toxicities except for transient and reversible hematologic toxicity in patients treated with Zevalin (Table 4). The median nadir platelet count was  $42,000/\mu L$ ; the median absolute neutrophil count was  $900 \times 10^6/L$ ; the median hemoglobin was 10.9 g/dL. Six percent of patients developed grade 4 thrombocytopenia (defined in this study as  $<10,000/\mu L$ ) and 25% developed grade 4 neutropenia ( $<500 \times 10^6/L$ ). Patients who developed grade 3 or 4 thrombocytopenia or neutropenia recovered their counts in a median of 12 and 14 days, respectively. Infection or hypogammaglobulinemia were uncommon.<sup>19</sup> Only 1 patient in each arm of the protocol has developed a HAMA/HACA to date.

The finding that bone marrow suppression was the main toxicity of Zevalin at 0.4 mCi/kg led to a separate clinical trial of reduced-dose Zevalin (0.3 mCi/kg) for patients with platelet counts between 100,000 and 149,000/ $\mu$ L.<sup>14</sup> Thirty patients were registered on this study, and it closed in August 1999 after meeting its targeted accrual. The results of the interim analysis on the first 24 patients were recently reported.<sup>14</sup> The median age of the patients was 61 years, and 25% of the patients were  $\geq$ 75 years old. The tumor histology was 83% follicular, 4% diffuse small lymphocytic, and 14% transformed from low-grade to intermediate-grade NHL. All patients had relapsed disease after having received chemotherapy. Biodistribution of Zevalin was measured by <sup>111</sup>In-Zevalin scans, and all patients met the dosimetry criteria to receive <sup>90</sup>Y-Zevalin. As expected, hematologic toxicity was the main toxicity. The median nadir absolute neutrophil count was  $600 \times 10^6$ /L, and 25% of patients experienced grade IV neutropenia. The median platelet count was 34,000/ $\mu$ L, and 15% of the patients experienced grade IV thrombocytopenia. The overall response rate was 68%, with 23% of patients obtaining CR and 45% a partial remission (PR). The duration of response and time to progression are not yet available.

Since the response rate to cold rituximab is  $\sim$ 50% and the duration of response  $\sim$ 1 year, there is a large group of patients who fail rituximab at some point. The goal of IDEC study 106-06 was to learn whether patients who had failed to respond with a PR or CR to rituximab or had a response that lasted  $<$ 6 months would respond to RIT with <sup>90</sup>Y-Zevalin. An interim analysis of the first 26 patients has recently been reported.<sup>15</sup> The median age of the treatment population was 56 years; 92% had tumors with a follicular histology, and the patients had received a median of 3 prior regimens. Forty-six percent of patients had bulky disease (defined as  $>$ 7 cm), and 27% had bone marrow involvement. The dosimetry determined by <sup>111</sup>In-Zevalin was acceptable in all cases. The nadir absolute neutrophil count was  $900 \times 10^6$ /L, and in 23% of patients, neutropenia was grade IV. The nadir platelet count was 34,000/ $\mu$ L, and thrombocytopenia was grade IV in 8%. The ORR was 46% and indicated that indeed the added <sup>90</sup>Y was beneficial.

The interim analysis of the randomized controlled trial of rituximab vs. Zevalin<sup>13</sup> and the ability of Zevalin to produce responses in patients who had failed rituximab<sup>15</sup> indicate that the addition of a radioactive particle to the monoclonal antibody does in fact improve the response rate vs. essentially the same antibody used without <sup>90</sup>Y. The only significant toxicity of Zevalin was hematologic, and this was reversible. The rare development of HAMA/HACA indicates that retreatment with Zevalin may be feasible; however, no clinical trials to date have recognized this. The lack of correlation between the special dosimetry performed in this trial and hematologic toxicity indicates that it may be optional in future trials of Zevalin. At this point, the first wave of studies on Zevalin have been completed, and the single-dose MTD and toxicity are now well established. The next

generation of clinical trials need to address the question of whether multiple doses of Zevalin can be safely provided and if they result in an increased complete remission rate and a longer time to progression. In addition, trials to integrate RIT with chemotherapy with or without stem cell support are needed to learn if these combinations can be safely given and if the cure rate can be increased.

## REFERENCES

1. Maloney D, Smith B, Appelbaum F. The anti-tumor effect of monoclonal anti-CD20 antibody (MAB) therapy includes direct anti-proliferative activity and induction of apoptosis in CD20 positive non-Hodgkin's lymphoma (NHL) cell lines [abstract]. *Blood* 88:637a, 1996.
2. McLaughlin P, Grillo-López A, Link B, et al. Rituximab chimeric anti-CD20 monoclonal antibody therapy for relapsed indolent lymphoma: half of patients respond to a four-dose treatment program. *J Clin Oncol* 16:2825–2833, 1998.
3. Czuczman M, Grillo-López A, White C, et al. Treatment of patients with low-grade B-cell lymphoma with the combination of chimeric anti-CD20 monoclonal antibody and CHOP chemotherapy. *J Clin Oncol* 17:268–276, 1999.
4. Kaminski MS, Zasadny KR, Francis IR, et al. Radioimmunotherapy of B-cell lymphoma with [<sup>131</sup>I]anti-B1 (anti-CD20) antibody. *N Engl J Med* 329:459–465, 1993.
5. Knox SJ, Goris ML, Trisler K, et al. Yttrium-90-labeled anti-CD20 monoclonal antibody therapy of recurrent B-cell lymphoma. *Clin Cancer Res* 2:457–470, 1996.
6. DeNardo SJ, DeNardo GL, Kukis DL, et al. <sup>67</sup>Cu-2IT-BAT-Lym-1 pharmacokinetics, radiation dosimetry, toxicity and tumor regression in patients with lymphoma. *J Nucl Med* 40:302–310, 1999.
7. Liu SY, Eary JF, Petersdorf SH, et al. Follow-up of relapsed B-cell lymphoma patients treated with iodine-131-labeled anti-CD20 antibody and autologous stem-cell rescue. *J Clin Oncol* 16:3270–3278, 1998.
8. Kaminski MS, Zasadny KR, Francis IR, et al. Iodine-131-anti-B1 radioimmunotherapy for B-cell lymphoma. *J Clin Oncol* 14:1974–1981, 1996.
9. Kaminski M, Gribbin T, Estes J, et al. I-131 anti-B1 antibody for previously untreated follicular lymphoma (FL): clinical and molecular remissions [abstract]. *Proc ASCO* 17:2a, 1998.
10. Press OW, Eary JF, Appelbaum FR, et al. Phase II trial of <sup>131</sup>I-B1 (anti-CD20) antibody therapy with autologous stem cell transplantation for relapsed B cell lymphomas. *Lancet* 346:336–340, 1995.
11. Press O, Eary J, Liu S, et al. A phase I/II trial of high dose iodine-131-anti-B1 (anti-CD20) monoclonal antibody, etoposide, cyclophosphamide, and autologous stem cell transplantation for patients with relapsed B cell lymphomas [abstract]. *Proc ASCO* 17:3a, 1998.
12. Witzig T, White C, Wiseman G, et al. Phase I/II trial of IDEC-Y2B8 radioimmunotherapy for treatment of relapsed or refractory CD20 positive B-cell non-Hodgkin's lymphoma. *J Clin Oncol* 17:3793–3803, 1999.
13. Witzig T, White C, Gordon L, et al. Prospective randomized controlled study of Zevalin

- (IDEC-Y2B8) radioimmunotherapy compared to rituximab immunotherapy for B-cell NHL report of interim results [abstract]. *Blood* 94 (Suppl 1):93a, 1999.
14. Witzig T, White C, Gordon L, et al. Reduced-dose Zevalin radioimmunotherapy for relapsed or refractory B-cell non-Hodgkin's lymphoma (NHL) patients with pre-existing thrombocytopenia: report of a phase II trial [abstract]. *Blood* 94:92a, 1999.
  15. Gordon L, White C, Witzig T, et al. Zevalin (IDEC-Y2B8) radioimmunotherapy of Rituximab refractory follicular non-Hodgkin's lymphoma (NHL): interim results [abstract]. *Blood* 94 (Suppl 1):91a, 1999.
  16. Wiseman G, White C, Stabin M, et al. Phase I/II IDEC-Y2B8 radioimmunotherapy dosimetry results in relapsed or refractory non-Hodgkin's lymphoma. *Eur J Nucl Med*. In press.
  17. Wiseman G, White C, Sparks R, et al. Biodistribution and dosimetry results from a phase III prospectively randomized controlled trial of Zevalin radioimmunotherapy for low-grade, follicular, or transformed B-cell non-Hodgkin's lymphoma. *Crit Rev Oncol Hematol*. In press.
  18. Witzig T, Leigh B, Gordon L, et al. Interim results from a prospective randomized controlled trial comparing Zevalin radioimmunotherapy to rituximab immunotherapy for B-cell non-Hodgkin's lymphoma: resistance to prior chemotherapy vs response rate [abstract]. *Proc ASCO* 19:29a, 2000.
  19. Gordon L, Wiseman G, Witzig T, et al. Zevalin induces transient neutropenia and B-cell depletion but does not induce clinically significant hypogammaglobulinemia nor serious infection risk [abstract]. *Proc ASCO* 19:23a, 2000.



# Posttransplant Immunotherapy for Multiple Myeloma Using Idiotype Vaccines

**Scott M. Schuetze, Barbara E. Smith, Donna Kelly, David G. Maloney**

*Fred Hutchinson Cancer Research Center (S.M.S., B.E.S., D.K., D.G.M.);  
University of Washington Medical Center (S.M.S., D.G.M.), Seattle, Washington*

## ABSTRACT

Multiple myeloma (MM)-produced immunoglobulin (idiotype [Id]) is a tumor-specific antigen and a stable target for immune-based therapy. Vaccination of patients with Id can result in immune responses directed against idiotypic determinants. Multiple strategies have been used to induce or amplify anti-Id cellular immunity in patients with non-Hodgkin's lymphoma (NHL) or MM following treatment with standard-dose or high-dose chemotherapy. However, the optimal time of immunization with a tumor antigen after autologous bone marrow transplantation (autoBMT) has not been determined. We are conducting a phase 1 trial of posttransplant vaccination of MM patients with purified Id conjugated to keyhole limpet hemocyanin (KLH) coadministered with granulocyte-macrophage colony-stimulating factor (GM-CSF) to determine the feasibility and safety of idiotype immunization and to assess humoral and cellular immune responses to KLH and to idiotype. Fourteen patients with disease responsive to high-dose chemotherapy or chemoradiotherapy have received 4 subcutaneous vaccinations with 1.0 mg Id-KLH given no earlier than 60 days posttransplant. One patient received 3 vaccinations. GM-CSF 250  $\mu$ g was administered with Id-KLH and was repeated daily for 3 consecutive days. Serum was analyzed by enzyme-linked immunosorbent assay (ELISA) to detect antibodies to Id and KLH. T cells were assayed for response to Id, isotype-matched allogeneic immunoglobulin (Ig), and KLH. Vaccinations have been well tolerated, and most patients experienced only minor, transient side effects. Seven of 10 patients vaccinated >100 days after transplant developed robust humoral and/or cellular immunity to KLH. In contrast, all 4 patients vaccinated <100 days posttransplant had delayed or blunted humoral and cellular immune responses to KLH. Anti-KLH antibodies and T cells could be detected for many months following immunization. Anti-idiotype antibodies have not been detected. Eight of 10 patients vaccinated >100 days posttransplant developed a transient cellular response to Id. The 4 patients immunized <100 days posttransplant did not develop anti-Id cellular responses. Anti-Id cellular immunity

can be amplified by vaccination with Id-KLH conjugate coadministered with GM-CSF in patients after autoBMT if vaccination is initiated >100 days posttransplant. The transient nature of the idiotype-reactive T cells suggests that these cells are downregulated or eliminated shortly after amplification. The clinical impact of *in vivo* amplified anti-Id cellular immune responses has not been determined. Additional approaches to maintain an amplified Id-specific immune response may be required to affect the disease course.

## INTRODUCTION

Multiple myeloma is a clonal disorder of late-stage B cells committed to the production of a single immunoglobulin (paraprotein). In 1998, an estimated 13,800 new cases of myeloma were diagnosed, and 11,300 people died from the disease. Myeloma is usually incurable, and median survival is only 30–36 months following diagnosis. High-dose chemotherapy with autologous stem cell support can improve the duration of survival, but relapse appears inevitable.<sup>1</sup> Allogeneic stem cell transplantation can cure a minority of patients, most likely through a graft-vs.-myeloma effect,<sup>2</sup> and infusions of allogeneic lymphocytes following relapse can induce antitumor responses, proving that MM is amenable to cellular immunotherapy.<sup>3,4</sup>

Immunoglobulin produced by B-cell malignancies can serve as a tumor-specific antigen and can be recognized by immune cells. During B-cell ontogeny, immunoglobulin heavy- and light-chain somatic gene rearrangements occur, and the variable region hypermutates after immunoglobulin interaction with antigen. The resultant immunoglobulin has amino acid sequences in the complementarity determining regions (CDRs) and a structure unique to that of the mature B cell. These unique antigenic sequences are termed idiotypes. Early clinical studies showed that monoclonal antibodies directed against Id produced by follicular lymphoma could result in clinically meaningful disease responses.<sup>5</sup> Relapse of disease was due to outgrowth of lymphoma with mutated Ig that did not react with the monoclonal antibody.<sup>6</sup> Vaccines usually generate polyclonal antibody responses. More recently, clinical trials using idiotype vaccines to circumvent the problem of Ig mutation suggest that long-term control of follicular lymphoma can be obtained in some patients who produce anti-idiotype antibodies and/or T cells.<sup>7,8</sup> The importance of anti-idiotype antibodies vs. anti-idiotype T cells in causing control of lymphoma is not known.

Analyses of MM Ig genes show somatic rearrangement and hypermutation but no intraclonal variation, implying that no further diversification occurs following malignant transformation.<sup>9,10</sup> Myeloma-produced immunoglobulin, therefore, is a stable target for immune-based therapy. However, there are problems with targeting myeloma idiotypes. Myeloma cells usually lack surface Ig but contain

cytoplasmic Ig that is secreted and accumulates in the serum. In patients with secretory disease, a humoral anti-Id response would likely be blocked from reaching tumor cells by the paraprotein and may not be active against surface Ig-negative myeloma cells. However, the induction of T cells directed against peptide fragments of the Ig presented on HLA class I or II molecules should provide activity even in the setting of circulating paraprotein and low surface immunoglobulin expression. Another impediment to the use of idiotype vaccines is that patients with myeloma may not be able to mount an immune response when there is a high level of circulating paraprotein. Preclinical studies of myeloma have shown that high circulating paraprotein levels are associated with unresponsiveness or anergy to Id vaccines.<sup>11</sup> Furthermore, Id-reactive T cells have been found more often in patients with early-stage than with advanced myeloma, suggesting that cellular immune responses are downregulated as the disease progresses.<sup>12</sup> Therefore, most trials of myeloma Id vaccines have enrolled patients after substantial cytoreduction of tumor, usually following high-dose therapy and stem cell transplantation.

We initiated a phase 1 clinical trial of vaccination with autologous purified idiotype paraprotein chemically conjugated to KLH coadministered with GM-CSF in patients with MM following recovery from peripheral blood stem cell transplants. The primary objectives of this trial are to determine the feasibility of paraprotein purification and vaccine derivation, the tolerability of repeated vaccination with idiotype-KLH administered with GM-CSF, and the ability of patients to mount detectable anti-idiotype T-cell responses. We report the preliminary results of the first 15 patients treated in this ongoing clinical trial.

## **MATERIALS AND METHODS**

### **Patients**

Fifteen patients enrolled in protocol 1104 at the Fred Hutchinson Cancer Research Center, the University of Washington, or the Seattle Veteran's Administration Medical Center between November 1997 and January 2000 were vaccinated with purified, autologous myeloma Ig conjugated to KLH as described below. Approval for the protocol was obtained from the Institutional Review Board, and an investigator sponsored an Investigational New Drug application with the US Food and Drug Administration. All patients provided written informed consent before treatment. Fourteen patients completed the planned series of vaccines; 1 withdrew from the study after receiving 3 vaccines because of rapidly progressive disease. Five patients underwent tandem autologous peripheral blood stem cell transplants using busulfan, melphalan, and thiotepa as conditioning for the first transplant and total body irradiation with lung and liver shielding as

conditioning for the second transplant. Four patients underwent single autologous transplants using busulfan, melphalan, and thiotepa for conditioning, and 3 of the 4 patients received infusion of peripheral blood stem cells incubated for 24 hours with interleukin (IL)-2 followed by continuous intravenous administration of IL-2 for 3 weeks. Four patients were conditioned with 20–40 Gy Holmium-166-DOTMP delivered to the red marrow with or without total marrow irradiation and melphalan, and 2 were conditioned with melphalan alone. All of the patients had a partial remission of disease after high-dose therapy as defined by a >75% reduction in the serum level of paraprotein 2 months after transplantation compared with the pretreatment value. Additional criteria to be eligible for vaccination included successful production of a pure, sterile vaccine, a delay of at least 60 days from the date of stem cell infusion to administration of the first vaccine, no severe regimen-related organ toxicities, and no concurrent use of systemic corticosteroids. Concurrent treatment with interferon- $\alpha$  was allowed.

### Treatment Schedule

Patients received subcutaneous injections of 1.0 mg idiotype-KLH conjugate mixed with 250  $\mu\text{g}$  GM-CSF (sargramostim; Immunex, Seattle, WA) at 0, 2, 6, and 10 weeks, starting no earlier than 60 days after infusion of stem cells (see Figure 1). GM-CSF 250  $\mu\text{g}$  was administered subcutaneously near the site of vaccination for 3 consecutive days after each dose of idiotype-KLH/GM-CSF. Myeloma was restaged before vaccination and at week 22. Five patients with disease at week 22 and a diminished immune response to myeloma idiotype received 2–4 booster immunizations given 1 month apart. Patients were followed every 3–6 months until disease progression.

### Humoral Responses

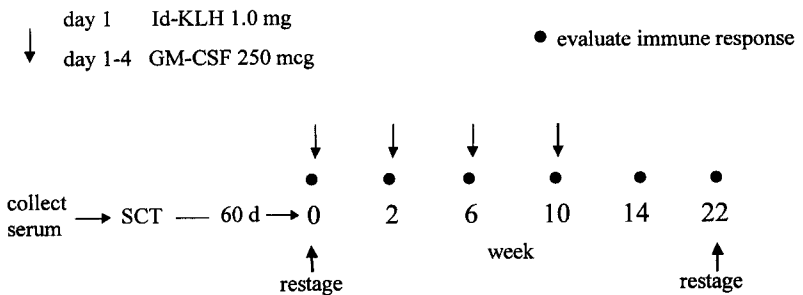
Microtiter plates (96-well Nunc-Immuno Plate; Nunc, Denmark) were coated with 40  $\mu\text{g}/\text{mL}$  KLH or purified myeloma idiotype overnight at 5°C and blocked with 1% bovine serum albumin (BSA) (Fraction V; Sigma, St. Louis, MO) in phosphate-buffered saline (PBS). Preimmune and postimmune serum samples were diluted in PBS containing 1% BSA and dispensed into wells. Bound Ig was detected using IgM-specific or IgG-specific goat anti-human antibodies conjugated to horseradish peroxidase (Caltag Laboratories, Burlingame, CA), 2,2'-azino-bis-3(ethylbenz-thiazoline-6-sulfonic acid) (Sigma), and an ELISA plate reader (SLT Lab Instruments, Grodig, Austria) set to detect absorbance at a wavelength of 405 nm. The relative antibody titer was the dilution of postimmune serum at the midpoint of the absorbance curve minus the dilution of preimmune serum at the midpoint of the absorbance curve.

## Cellular Responses

Heparinized blood was obtained before administration of each vaccine, at 1 and 3 months after the fourth vaccine, and at other times as indicated. Peripheral blood mononuclear cells (PBMCs) were isolated by centrifugation of blood on a Ficoll-Hypaque cushion. PBMCs were washed in PBS, resuspended in RPMI-HEPES medium containing 11% heat-denatured human AB serum (Gemini Bioproducts, Woodlawn, CA), 4 mM L-glutamine, 100 U/mL penicillin, and 100  $\mu\text{g}/\text{mL}$  streptomycin, and plated at  $2\text{--}3 \times 10^5$  cells per well in 96-well, round-bottom tissue culture plates (Nunc). Cells were cultured with no antigen, 1  $\mu\text{g}/\text{mL}$ , 10  $\mu\text{g}/\text{mL}$ , 50  $\mu\text{g}/\text{mL}$ , and 100  $\mu\text{g}/\text{mL}$  of purified idiotype, isotype-matched Ig. and KLH at 37°C in 5% CO<sub>2</sub> for 6 days. All cultures were performed in triplicate. [<sup>3</sup>H]thymidine 1  $\mu\text{Ci}$  was added to each well for the final 18–20 hours of culture. DNA was harvested on microfiber filters, and the amount of [<sup>3</sup>H]thymidine incorporated into DNA was determined by scintillation counting using Scinti-safe Econo F (Fischer Scientific) and a Beckman LS 6000 SC counter. A stimulation index (SI) for each antigen was determined by the following calculation (SI >2 was evidence of reactivity to antigen):

$$\frac{\text{average cpm of cells cultured with antigen} - \text{background cpm in media}}{\text{cpm of cells cultured without antigen} - \text{background cpm in media}}$$

### Vaccination Schema



**Figure 1.** Schematic of treatment using purified myeloma idiotype (Id)/keyhole limpet hemocyanin (KLH) vaccines. Each patient's serum was collected and stored prior to high-dose therapy. Sixty or more days after peripheral blood stem cell transplant (SCT), myeloma was staged and the myeloma idiotype-KLH vaccine was administered with concurrent granulocyte-macrophage colony-stimulating factor (GM-CSF) at weeks 0, 2, 6, and 10 of treatment. Before each vaccination and at 1 and 3 months after the fourth immunization, patient interval history was obtained, physical examination and laboratory analysis were performed to evaluate safety, and immune responses to idiotype and KLH were assayed. Myeloma was staged 3 months after the fourth vaccine was administered to follow disease response.

## RESULTS

## Patient Characteristics

Fourteen patients with multiple myeloma were vaccinated at least 4 times with purified, autologous myeloma idiotype conjugated to KLH after autologous peripheral blood stem cell transplants. One patient received 3 vaccines but withdrew from study because of rapidly progressive disease. All of the patients had a partial disease remission after autologous transplantation. Patient characteristics are shown in Table 1. Ten patients had IgG1 myeloma, 3 had IgA myeloma, 1 had IgG4 myeloma, and 1 had IgM myeloma. Twelve of the 15 patients were male. A mean of  $6.62 \times 10^6$  CD34<sup>+</sup> cells/kg was infused after high-dose chemotherapy or chemoradiotherapy. At the time of vaccination, patients' ages ranged from 39 to 68 years (median, 53 years). The first vaccine was given 65–376 days (median, 129 days) posttransplant. The median level of myeloma paraprotein in the serum was 700 mg/dL, and the level of polyclonal IgG was 428 mg/dL, with ranges of 0–2300 mg/dL and 20–1480 mg/dL, respectively.

**Table 1.** Patient Characteristics\*

UPN	Sex	Age, y	Isotype	CD34 <sup>†</sup>	Interval, d <sup>‡</sup>	M-spike, g/dL <sup>§</sup>	IgG, mg/dL <sup>  </sup>
27	F	56	IgA $\kappa$	4.54	137	0.2	1250
29	M	64	IgG1 $\kappa$	2.78	119	0.9	580
33	M	45	IgG4 $\kappa$	6.91	114	0.5	780
41	M	65	IgG1 $\kappa$	7.51	73	1.9	850
44	M	46	IgG1 $\kappa$	5.90	95	1.8	20
48	M	39	IgG1 $\kappa$	8.71	69	1.0	50
51	M	68	IgG1 $\lambda$	5.18	65	0.7	410
52	M	61	IgG1 $\lambda$	7.80	167	2.5	0
64	F	58	IgA $\lambda$	6.24	376	0.4	120
66	M	49	IgG1 $\kappa$	20.13	126	0.5	560
78	M	42	IgM $\kappa$	5.27	171	0.3	500
82	F	46	IgG1 $\lambda$	4.36	132	0.2	1480
86	M	53	IgA $\kappa$	5.33	143	0.2	425
88	M	59	IgG1 $\kappa$	3.26	233	1.4	280
96	M	52	IgG1 $\kappa$	NA	167	2.3	330

\*Ig, immunoglobulin; NA, not available; UPN, universal patient number. <sup>†</sup>Dose of CD34<sup>+</sup> cells per kilogram body weight infused for peripheral blood stem cell transplant. <sup>‡</sup>Time from infusion of stem cells to administration of first vaccine. <sup>§</sup>Level of paraprotein in serum at the time of the first vaccine. <sup>||</sup>Level of normal immunoglobulin G in serum at the time of the first vaccine.

## Toxicity

Patients received 4 subcutaneous injections of 0.5 mg purified, autologous myeloma idiotype conjugated to 0.5 mg KLH and mixed with 250  $\mu$ g GM-CSF. For 3 consecutive days after each vaccination, patients self-administered 250  $\mu$ g GM-CSF in the same site as the Id-KLH vaccine. All of the vaccines were given in the thigh. Side effects were monitored by patient self-report forms, patient history, physical examinations, analysis of complete blood counts, comprehensive serum metabolic panels, and urinalysis performed before each and 1 and 3 months after the fourth immunization. A total of 77 vaccines were given to the 15 patients. Most of the vaccines were well tolerated, and adverse events were self-limited. Four patients reported no side effects with the first 4 vaccines. Thirty-three of the vaccines (44%) were associated with National Cancer Institute (NCI) grades 1–2 local skin erythema or induration. Twenty-one of the vaccines (28%) were associated with grades 1–2 arthralgia or bone pain, 19% with grade 1 nausea or diarrhea, 12% with grade 1 headache, and 8% with grade 1 fever or chills. One patient developed a grade 3 pneumonitis 4 weeks after receiving the fourth vaccine, and 1 patient developed a grade 4 pneumonitis 2 weeks after receiving a sixth vaccine. Chest roentgenograms and computed tomography scans showed diffuse bilateral pulmonary infiltrates. Bronchoalveolar lavage and transbronchial biopsy failed to identify an infectious etiology. IgM and IgG anti-GM-CSF antibodies were not detected (data not shown). The grade 3 pneumonitis resolved without treatment, and the grade 4 pneumonitis resolved with broad-spectrum parenteral antimicrobial agents and systemic corticosteroids. One patient developed a central catheter-associated venous thrombus 1 month after receiving the fourth vaccine. The highest grades of the adverse events experienced by each patient are shown in Table 2. Hematologic adverse events were determined using the lowest values obtained during study for each patient regardless of the values obtained before administration of the first vaccine. The hematologic abnormalities were mostly pre-existing mild to moderate pancytopenias from stem cell transplant. Two patients with rapidly progressive disease on study had a significant drop in circulating neutrophils, and 1 of the patients experienced a decline in circulating platelets accounting for 2 of the grade 3 neutropenia events and the grade 3 thrombocytopenia. The 1 patient with grade 4 neutropenia and 1 patient with grade 3 neutropenia were also receiving concurrent interferon. Peripheral neutrophil counts recovered following discontinuation or dose reduction of interferon. One patient developed grade 3 neutropenia without an identifiable cause. One case of acute sinusitis and 1 case of lobar pneumonia occurred and resolved with antibiotic therapy.

**Table 2.** Adverse Events\*

	Grade 1	Grade 2	Grade 3	Grade 4
Local	1	10	0	0
Skin	1	2	0	0
Headache	5	0	0	0
Bone pain	5	2	0	0
Fever	4	0	0	0
Chills	3	0	0	0
Nausea	5	0	0	0
Diarrhea	1	0	0	0
Neutropenia	1	1	4	1
Anemia	7	7	0	0
Thrombocytopenia	7	2	1	0
Pulmonary	0	0	1	1
Alkaline phosphatase	2	0	0	0
Thrombosis	0	0	0	1

\*Toxicities associated with myeloma idiotype–keyhole limpet hemocyanin vaccines and granulocyte-macrophage colony-stimulating factor. The highest grade toxicity for each patient per category is listed. Toxicity grading is according to the National Cancer Institute system.

### Humoral and Cellular Responses to a Neoantigen

Keyhole limpet hemocyanin is a strongly antigenic protein. Anti-KLH IgM and IgG antibody titers and stimulation indices were determined to assess the competence of the immune system to a foreign antigen. Five of 15 patients developed anti-KLH IgM and IgG antibodies by 4 weeks after the second vaccine, and 11 of 15 patients produced anti-KLH antibodies by 4 weeks after the fourth vaccine. None of the 4 patients vaccinated earlier than 100 days after transplant developed anti-KLH antibodies after the second vaccine, compared with 5 of 11 patients vaccinated more than 100 days after transplant. Relative anti-KLH IgM titers were 100, whereas IgG titers were 1000 at 4 weeks after the second vaccine and 10,000 at 4 weeks after the fourth vaccine.

A cellular immune response to KLH developed earlier than anti-KLH antibodies in most patients. One patient who was an avid saltwater fisherman had a T-cell response to KLH prior to transplant that was significantly boosted by the myeloma-KLH vaccines. Two patients developed anti-KLH T-cell responses within 2 weeks of the first vaccine, 8 patients developed cellular anti-KLH responses within 4 weeks of the second vaccine, 1 patient developed a response after the fourth vaccine, and 3 patients did not mount anti-KLH T-cell responses. Overall, 12 of 15 patients had a T-cell response to KLH. Two of 4 patients immunized <100 days after transplant developed anti-KLH T-cell responses after



the second vaccine compared with 8 of 11 patients vaccinated >100 days after infusion of PBMCs. For most of the patients, the SI for KLH increased with each subsequent vaccine. The median SI for KLH in responders after 2 vaccines was 44, and after 4 vaccines was 205, with ranges of 7.4–230 and 5.6–895, respectively. T-cell responses to KLH have been detected for more than 1 year after vaccination in some patients.

### **Humoral and Cellular Responses to Purified Idiotype**

Humoral responses to myeloma idiotype have not been observed. Circulating myeloma paraprotein would likely bind anti-idiotype antibodies *in vivo* and prevent the detection of anti-idiotype antibodies in ELISA. Anti-idiotype IgM antibodies have not been detected (data not shown). Serum from patients with non-IgG paraprotein and from patients without detectable paraprotein by protein electrophoresis was assayed for anti-idiotype IgG antibodies. We were unable to detect IgG isotype anti-idiotype antibodies in these patients (data not shown).

Cellular responses to purified myeloma idiotype were detected in 10 of 15 patients. Two patients developed a response within 2 weeks of receiving the first vaccine, 4 patients developed a response within 4 weeks of receiving the second vaccine, 2 patients developed a response within 4 weeks of the third vaccine, 1 patient developed a response after the fourth vaccine, and 1 patient developed a response after a fifth vaccine. Seven of 9 patients with a paraprotein level of <1 g/dL had a detectable T-cell response to idiotype, whereas only 2 of 6 with a paraprotein level of  $\geq 1$  g/dL had a response. None of the four patients vaccinated <100 days after transplant had a response. The magnitudes of the SI to idiotype were substantially lower than to KLH. The median maximal SI to idiotype in responders was 3.8, with a range of 2.0 to 5.8. T-cell responses to an insoluble glutaraldehyde conjugated form of idiotype in responders were reproducibly higher than to soluble antigen and may have been due to more efficient antigen uptake, processing, and presentation by antigen-presenting cells or to presentation of novel peptide sequences created through conjugation (data not shown). Cellular responses to idiotype were transient. In some patients, responses could be detected within a few days to 2 weeks after vaccination but not at 4 weeks. Long-term persistence of idiotype-reactive T cells has not been seen.

### **Clinical Responses**

This phase 1 trial of idiotype vaccination was not designed to determine the response of myeloma to idiotype vaccines. However, myeloma was restaged using protein electrophoresis, bone marrow biopsy, and fluorescence-activated cell sorting (FACS) analysis of bone marrow aspirates before administration of the first

vaccine and 3 months after administration of the fourth vaccine. In 5 patients, there was a minor response in the serum paraprotein level and/or diminution of myeloma cells in the marrow, 7 patients had stable disease, and 3 patients had progressive disease. With longer follow-up, disease has remained stable in 8 patients, and 4 patients have died from progressive myeloma. The Kaplan-Meier estimate of the median time to progression of myeloma from autologous stem cell transplant for all vaccinated patients is 800 days.

## DISCUSSION

Multiple myeloma is a largely incurable disease despite sensitivity to corticosteroids, chemotherapeutics, and radiation. Additional therapies are needed to eradicate myeloma, because chemotherapy and radiation are already given at maximally tolerated doses in stem cell transplant conditioning regimens. Immunotherapy is an attractive approach to treat myeloma, because disease responses to infusions of allogeneic donor lymphocytes and to nonmyeloablative allogeneic transplants have been documented, suggesting that myeloma can be eradicated by components of the immune system. The antigens and immune cells responsible for the graft-vs.-myeloma effect have not been identified. Myeloma-produced immunoglobulin is a readily accessible tumor antigen, and studies of idiotype immunization in follicular lymphoma support the potential role of idiotype vaccines in B-cell malignancies.

The isolation, conjugation, and administration of myeloma-produced immunoglobulin as an idiotype vaccine is feasible and safe. Purification of idiotype was possible in all cases where paraprotein was at least 1 g/dL of serum and when supplemental polyclonal immunoglobulin was not used before collection of serum. Administration of myeloma idiotype conjugated to KLH was well tolerated by most patients. Side effects were usually grades 1 or 2 and were self-limited. The most frequent adverse event was a local reaction of pain, erythema, and/or induration that was consistent with an immediate and/or a delayed-type hypersensitivity reaction to the immunogen or to GM-CSF. Local reactions tended to become more severe with subsequent administrations of the vaccine but never resulted in skin ulceration. The common systemic symptoms (eg, bone pain, headache, low-grade fevers, and nausea) were most likely due to GM-CSF. These symptoms usually occurred on the second day of cytokine administration and resolved 1–2 days after completion of GM-CSF. Two patients developed pneumonitis; 1 required corticosteroids for treatment. Bronchoalveolar lavage did not identify an infectious etiology. The cause of the pulmonary reaction was not determined. In some patients with high numbers of circulating malignant B cells, infusions of anti-CD20 antibody have been associated with an acute pulmonary syndrome.<sup>13</sup> In both cases of pneumonitis in our patients, the level of paraprotein

in the serum was  $>1$  g/dL, but anti-idiotypic antibodies were not detected. The frequent development of nonneutralizing antibodies to GM-CSF in breast cancer patients vaccinated with a peptide-based vaccine using recombinant human GM-CSF as an adjuvant has been described,<sup>14</sup> but the presence of anti-GM-CSF antibodies was not associated with any clinical adverse event, and anti-GM-CSF antibodies were not detected in the 2 patients with pneumonitis (data not shown). The frequency of side effects from repeated idiotype vaccinations in a similar trial conducted in Europe were not described, but no World Health Organization (WHO) grade 3 or 4 toxicities were seen, and most of the WHO grade 1 and 2 toxicities were attributed to cytokines.<sup>15</sup> Similar local reactions were described by Reichardt et al.<sup>16</sup> in patients who received infusions of idiotype-pulsed autologous dendritic cells followed by subcutaneous injections of idiotype conjugated to KLH. GM-CSF was not used in that study. Infusions of dendritic cells were well tolerated, although 2 patients developed low-grade fevers and 1 patient developed a postinfusion thrombophlebitis.

The best immunization strategy and time to administer idiotype vaccines are not known. Patients with a lower burden of disease are probably more able to respond to antitumor vaccines, but this hypothesis has not been tested. In early-stage myeloma with low levels of paraprotein, isolation of tumor antigen is more difficult. Patients who obtain a complete or partial remission of disease to treatment provide a rational setting to test the potential efficacy of anti-idiotypic vaccines. Reichardt et al.<sup>16</sup> studied the anti-KLH and anti-idiotypic cellular responses in 12 patients with myeloma 3–7 months after autologous peripheral blood stem cell transplant. The patients' immune systems were primed with 2 monthly infusions of idiotype-pulsed, autologous mononuclear cells enriched for dendritic cells by density gradient centrifugation. Subsequently, patients received 5 monthly subcutaneous administrations of purified idiotype conjugated to KLH. Anti-KLH T-cell responses were detected in 11 of 12 patients. The patient who did not mount an anti-KLH response developed acute myelogenous leukemia shortly after administration of the second idiotype-KLH vaccine. The 2 patients who had a complete response to high-dose therapy developed anti-idiotypic T-cell responses; in 1 patient, the response was detected after administration of the first idiotype-KLH vaccine, and in the other patient, the response was detected after administration of the fifth vaccine. The anti-idiotypic T-cell response was 20-fold less robust than the anti-KLH T-cell response in the patient for whom a comparison was made. Antibody responses were not reported. The contribution of the idiotype-pulsed dendritic cell infusions to the efficacy of the immunization strategy is not known.

Massaia et al.<sup>15</sup> used an immunization strategy similar to the regimen we are studying. They administered a series of 7 idiotype-KLH vaccines to 12 patients between 2 and 17 months after peripheral blood stem cell transplant. Five of the 12 patients were 2 months posttransplant. The Id-KLH vaccines were administered

with 5 days of either IL-2 (2 patients) or GM-CSF (10 patients). Immune responses to idiotype and to KLH were analyzed 1 month after administration of the seventh vaccine. Anti-KLH antibodies were detected in all of the patients, and T cells were detected in 9 of the patients. Anti-idiotype antibodies using a sandwich ELISA were not detected. Anti-idiotype T cells were detected in 1 patient with myeloma in a partial remission vaccinated 2 months after infusion of stem cells and in another patient with a complete remission who was immunized 8 months after transplant.

Immune responses to myeloma idiotype induced by vaccination have been difficult to detect. Osterborg et al.<sup>12</sup> detected low numbers of B cells that expressed idiotype-reactive IgM following vaccination of myeloma patients with idiotype and GM-CSF, but anti-Id IgM titers were not reported. We and Massaia et al.<sup>15</sup> were unable to detect anti-idiotype antibodies in serum using 2 different ELISA methods. If anti-idiotype antibodies were induced by vaccination, it is likely that myeloma paraprotein circulating in the serum would bind the antibodies and prevent their detection in assays. The importance of anti-idiotype antibodies in the control or eradication of residual disease is not known; however, the presence of anti-idiotype antibodies after vaccination of patients with follicular lymphoma has been associated with longer control of disease even in the absence of detectable anti-idiotype T cells.<sup>8</sup>

In all 3 studies, idiotype-reactive T cells were more difficult to generate or detect than anti-KLH T cells (Table 3). The SI of lymphocytes exposed to idiotype was 10- to 50-fold less than to KLH, suggesting a much lower frequency of circulating idiotype-reactive T cells, a lower proliferative capacity upon engaging antigen, or a low-affinity antigen binding site. T cells responding to idiotype were more readily detected in patients with a lower burden of disease. These findings are consistent with previous preclinical and clinical observations that idiotype-reactive T cells are eliminated in advanced myeloma and suggest that antimyeloma vaccines are more likely to elicit meaningful immune responses in the setting of minimal disease. In our observations, Id-reactive T cells could be detected within 4 days to 2 weeks but not at 4 weeks after vaccination in some patients. This may be due to trafficking of lymphocytes to sites of residual disease. Alternatively, idiotype-reactive T cells may be deleted by immunoregulatory mechanisms shortly after their generation. The induction of anti-idiotype T cells in a higher percentage of patients in our study (10 of 15 patients) contrasted with that reported by Reichardt et al.<sup>16</sup> (2 of 12 patients) and Massaia et al.<sup>15</sup> (2 of 12 patients) and may have been due to the earlier time after immunization that analyses were performed. Reichardt et al.<sup>16</sup> studied T-cell responses to idiotype 4 weeks after each vaccination with idiotype-KLH, and Massaia et al.<sup>15</sup> looked for anti-idiotype responses 4 weeks after the seventh vaccine was administered. Anti-idiotype T-cell responses may be only transiently detectable; thus, the timing of analysis is likely to be important in determining

**Table 3.** Induction of Immune Responses to Idiotype-KLH Vaccines\*

<i>Study</i>	<i>Anti-KLH Ab Response</i>	<i>Anti-KLH T-Cell Response</i>	<i>Anti-Idiotype Ab Response</i>	<i>Anti-Idiotype T-Cell Response</i>
This study	11/15	12/15	0/5	10/15
Massaia et al. <sup>15</sup>	12/12	9/11	0/12	2/11
Reichardt et al. <sup>16</sup>	Not reported	11/12	Not reported	2/12
Total	23/27	32/38	0/17	14/38

\**Ab, antibody; KLH, keyhole limpet hemocyanin.*

whether the immunization procedure was successful in eliciting a response.

The optimal vaccine strategy for inducing anti-idiotype responses is not known, but the 2 reported approaches are the use of protein-pulsed autologous dendritic cells for primary immunization followed by booster injections of antigen and the subcutaneous or intradermal administration of antigen with an immunomodulatory cytokine such as GM-CSF. The collection, isolation or ex vivo differentiation, and reinfusion of autologous dendritic cells is a labor-intensive, expensive, and invasive process. GM-CSF is a commercially available cytokine that promotes differentiation of myeloid precursors into dendritic cells capable of uptake and processing of antigen.<sup>17</sup> Vaccine studies using a mouse model of lymphoma have shown that GM-CSF administered with a weakly immunogenic idiotype antigen induced potent CD4 and CD8 responses directed against idiotype.<sup>18</sup> Infusions of peptide or protein-pulsed dendritic cells have not been shown to be superior to the subcutaneous administration of GM-CSF and antigen for inducing protective antitumor immune responses in humans. Our ability to stimulate anti-KLH and anti-idiotype responses and that reported by Massaia et al.,<sup>15</sup> using subcutaneous administration of antigen and GM-CSF, appear to be equivalent to using protein-pulsed dendritic cells<sup>16</sup> (Table 3).

The clinical benefit of vaccination with Id-KLH coadministered with GM-CSF is not yet known. Most of the patients in our study had stable, detectable disease during the 6 months they were receiving the vaccines and follow-up care. Five patients had a <50% reduction in the serum level of paraprotein, but it is not known if this response was due to delayed effects of high-dose therapy or to effects of the Id-KLH vaccines. One minor disease response was seen by Reichardt et al.<sup>16</sup> in 1 patient who was vaccinated 6 months after an autologous stem cell transplant. Significant clinical responses to idiotype immunization were not seen in the study reported by Massaia et al.<sup>15</sup> Only 4 patients (from the 3 studies) had progressive disease while receiving the immunizations; therefore, it is unlikely that Id-KLH vaccines accelerated myeloma recurrence.

Our results and the findings of Reichardt et al.<sup>16</sup> and Massaia et al.<sup>15</sup> show that myeloma paraprotein can be readily purified and formulated into a tumor-specific

vaccine and administered safely to patients after high-dose therapy and autologous peripheral blood stem cell transplants. The challenge is to devise a method of immunization that results in a greater likelihood and longer persistence of a cellular anti-idiotypic response. We are administering idiotype-KLH vaccines along with daily, low-dose IL-2 to provide T-cell help to determine whether idiotype-reactive lymphocytes can be more easily detected and maintained. Additionally, we are administering idiotype-KLH vaccines to patients after allogeneic transplants with the hope of avoiding possible deletion of autoreactive T cells. Novel vaccine strategies may be able to eliminate residual myeloma after substantial cytoreduction with chemotherapy and radiotherapy.

### ACKNOWLEDGMENTS

This work was supported in part by a Benson Klein research grant from the International Myeloma Foundation to S. Schuetze.

### REFERENCES

1. Harousseau JL, Attal M, Divine M, et al. Autologous stem cell transplantation after first remission induction treatment in multiple myeloma: a report of the French Registry on Autologous Transplantation in Multiple Myeloma. *Stem Cells* 13 (Suppl 2):132–139, 1995.
2. Bensinger WI, Buckner CD, Anasetti C, et al. Allogeneic marrow transplantation for multiple myeloma: an analysis of risk factors on outcome. *Blood* 88:2787–2793, 1996.
3. Tricot G, Vesole DH, Jagannath S, Hilton J, Munshi N, Barlogie B. Graft-versus-myeloma effect: proof of principle. *Blood* 87:1196–1198, 1996.
4. Verdonck LF, Lokhorst HM, Dekker AW, Nieuwenhuis HK, Petersen EJ. Graft-versus-myeloma effect in two cases. *Lancet* 347:800–801, 1996.
5. Davis TA, Maloney DG, Czerwinski DK, Liles TM, Levy R. Anti-idiotypic antibodies can induce long-term complete remissions in non-Hodgkin's lymphoma without eradicating the malignant clone. *Blood* 92:1184–1190, 1998.
6. Meeker T, Lowder J, Cleary ML, et al. Emergence of idiotype variants during treatment of B-cell lymphoma with anti-idiotypic antibodies. *N Engl J Med* 312:1658–1665, 1985.
7. Bendandi M, Gocke CD, Kobrin CB, et al. Complete molecular remissions induced by patient-specific vaccination plus granulocyte-monocyte colony-stimulating factor against lymphoma. *Nat Med* 5:1171–1177, 1999.
8. Hsu FJ, Caspar CB, Czerwinski D, et al. Tumor-specific idiotype vaccines in the treatment of patients with B-cell lymphoma: long-term results of a clinical trial. *Blood* 89:3129–3135, 1997.
9. Kosmas C, Stamatopoulos K, Papadaki T, et al. Somatic hypermutation of immunoglobulin variable region genes: focus on follicular lymphoma and multiple myeloma. *Immunol Rev* 162:281–292, 1998.
10. Bakkus MH, Heirman C, Van Riet I, Van Camp B, Thielemans K. Evidence that multi-

- ple myeloma Ig heavy chain VDJ genes contain somatic mutations but show no intraclonal variation. *Blood* 80:2326–2335, 1992.
11. Bogen B. Peripheral T cell tolerance as a tumor escape mechanism: deletion of CD4<sup>+</sup> T cells specific for a monoclonal immunoglobulin idiotype secreted by a plasmacytoma. *Eur J Immunol* 26:2671–2679, 1996.
  12. Yi Q, Osterborg A, Bergenbrant S, Mellstedt H, Holm G, Lefvert AK. Idiotype-reactive T-cell subsets and tumor load in monoclonal gammopathies. *Blood* 86:3043–3049, 1995.
  13. Byrd JC, Waselenko JK, Maneatis TJ, et al. Rituximab therapy in hematologic malignancy patients with circulating blood tumor cells: association with increased infusion-related side effects and rapid blood tumor clearance. *J Clin Oncol* 17:791–795, 1999.
  14. McNeel DG, Schiffman K, Disis ML. Immunization with recombinant human granulocyte-macrophage colony-stimulating factor as a vaccine adjuvant elicits both a cellular and humoral response to recombinant human granulocyte-macrophage colony-stimulating factor. *Blood* 93:2653–2659, 1999.
  15. Massaia M, Borrione P, Battaglio S, et al. Idiotype vaccination in human myeloma: generation of tumor-specific immune responses after high-dose chemotherapy. *Blood* 94: 673–683, 1999.
  16. Reichardt VL, Okada CY, Liso A, et al. Idiotype vaccination using dendritic cells after autologous peripheral blood stem cell transplantation for multiple myeloma: a feasibility study. *Blood* 93:2411–2419, 1999
  17. Warren TL, Weiner GJ. Uses of granulocyte-macrophage colony-stimulating factor in vaccine development. *Curr Opin Hematol* 7:168–173, 2000.
  18. Kwak LW, Young HA, Pennington RW, Weeks SD. Vaccination with syngeneic, lymphoma-derived immunoglobulin idiotype combined with granulocyte/macrophage colony-stimulating factor primes mice for a protective T-cell response. *Proc Natl Acad Sci U S A* 93:10972–10977, 1996.





# **CHAPTER 6**

## **NEW AVENUES**



# **Optimization of Hematopoietic Stem Cell Gene Transfer Methods Using the Nonhuman Primate Competitive Repopulation Model: Recent Progress Toward Clinical Application**

***J.F. Tisdale, S.A. Tuchman, T. Wu, H.J. Kim, S.E. Sellers, E.M. Kang, R.A. Donahue, C.E. Dunbar***

*Molecular and Clinical Hematology Branch (J.F.T., S.A.T., E.M.K.), National Institute of Diabetes and Digestive and Kidney Disorders, and Hematology Branch (T.W., H.J.K., S.E.S., R.A.D., C.E.D.), National Heart, Lung, and Blood Institute, National Institutes of Health, Bethesda, Maryland*

## **ABSTRACT**

Although encouraging results in murine hosts were reported more than a decade ago, the successful widespread clinical application of hematopoietic stem cell-based gene transfer methods using integrating vectors has been hampered predominantly by the low percentage of genetically modified cells attainable in large animals and humans to date. A number of approaches aimed at increasing the chances of vector and target cell interaction, such as pseudotyping of vector particles with alternative envelope proteins, colocalization of vector and target cells on recombinant human fibronectin fragments, and inclusion of various primitively acting hematopoietic growth factors during transduction, have been proposed based on both in vitro and murine in vivo data. To develop highly efficient, clinically feasible transduction methods appropriate for human clinical trials, we have focused on the rhesus macaque (*Macaca mulatta*) competitive repopulation model, exploiting the similarities between rhesus and human cytokine influences, stem cell cycling kinetics, hematopoietic demand, and retrovirus cell surface receptor distribution. In this model, using a standard 4-day transduction with daily retrovirus exposure, we have recently obtained clinically relevant levels of genetically modified circulating progeny at 10% or higher over a prolonged follow-up period posttransplantation through the addition of Flt-3 ligand (FL) and autologous stroma to our standard growth factor combination including interleukin (IL)-3, IL-6, and stem cell factor (SCF). We have extended our studies to compare transduction on the fibronectin fragment CH-296 to that performed on autologous stroma and alternative cytokine

combinations including megakaryocyte growth and development factor (MGDF) with equivalent, high-level marking. This high-level marking has allowed retroviral integration site detection using an inverse polymerase chain reaction (PCR) technique. In 2 animals followed for >1 year posttransplantation, the contribution to hematopoiesis by genetically modified cells is polyclonal, with common integration sites among different hematopoietic lineages, suggesting successful transduction of truly pluripotent hematopoietic progenitors. The stable, high-level *in vivo* gene marking derived from multiple transduced clones attainable in our nonhuman primate model is encouraging for the eventual successful application of hematopoietic stem cell-based gene transfer in humans.

## INTRODUCTION

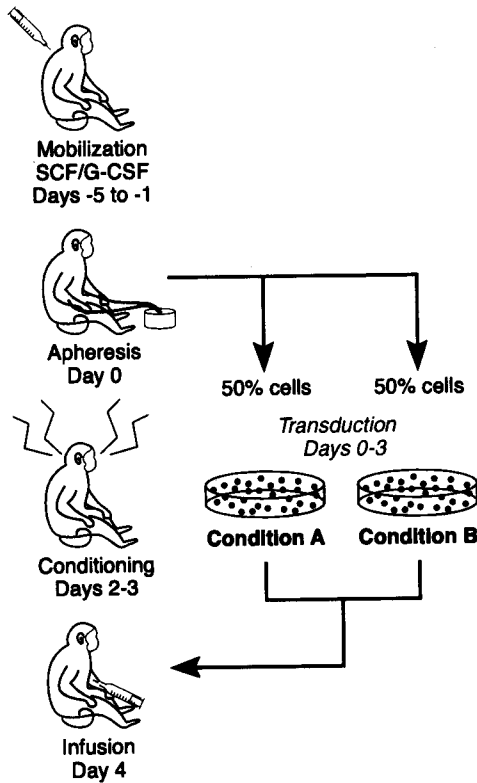
Despite encouraging results observed in initial studies investigating hematopoietic progenitor gene transfer in murine and human *in vitro* models, pilot human trials using similar techniques were far less encouraging.<sup>1</sup> Recognizing that further exploration was required in an animal model that was hematopoietically more closely related to humans, we focused on a nonhuman primate, the rhesus macaque. Specifically, we employed a competitive repopulation model.

Our goals have been to optimize hematopoietic stem cell gene transfer to develop techniques that would be clinically applicable as an approach to curing diseases with genetic etiologies. By comparing a variety of cytokine combinations and support media, we have increased engraftment of genetically modified rhesus peripheral blood (PB) hematopoietic progenitor cells posttransplant from previously undetectable levels to a not only detectable, but also clinically relevant range upwards of 10%.<sup>2</sup> Engraftment in that range has enabled us to further investigate and characterize hematopoiesis in the rhesus. We have found that in rhesus monkeys transplanted with retrovirally transduced PB progenitors, hematopoiesis is derived from multiple stem or progenitor cells. Furthermore, our work has demonstrated that those cells give rise to multilineage hematopoietic cells, and certain individual clones can contribute to hematopoiesis over the course of at least 1 year.

## MATERIALS AND METHODS

### **The Rhesus Competitive Repopulation Model as Applied in These Studies**

Methods are described elsewhere in detail; a brief description follows. Figure 1 also summarizes the general model. Young rhesus macaques used in all studies were handled and housed in accordance with National Institutes of Health (NIH) guidelines. Peripheral blood progenitors were obtained by mobilization and apheresis and enriched for the primitive compartment by CD34 selection.<sup>3</sup>



**Figure 1.** Rhesus competitive repopulation model. Rhesus macaques underwent mobilization with stem cell factor (SCF) and granulocyte-macrophage colony-stimulating factor (GM-CSF) for 5 consecutive days. Mobilized peripheral blood progenitors were then collected by apheresis, enriched for primitive progenitors by CD34 selection, and split into 2 equal fractions. Each fraction was placed under different transduction conditions and marked with 1 of the 2 phenotypically identical but genotypically differing retroviruses containing the G418 resistance gene *neo*. Rhesus monkeys were conditioned with 500 cGy, and on day 3 or 4 following apheresis, both aliquots of transduced cells were simultaneously reinfused into the same monkey.

The G1Na and LNL6 retroviral vectors used in all studies carry identical bacterial neomycin phosphotransferase (*neo*) genes that confer G418 resistance. The vectors differ by a 16-base-pair polylinker 5' to the *neo* gene, which enables differentiation by PCR.<sup>1</sup>

For each animal, PB progenitor cells were divided equally and transduced for 4 days with freshly collected G1Na or LNL6 retroviral supernatant. Each aliquot was cultured under unique conditions to test the effects of those conditions on engraftment by genetically modified cells. On the 2 days following apheresis, the

animals were conditioned with 500 cGy total body irradiation. Following transduction, the cells from the 2 aliquots of each animal were collected, recombined, and infused into the same animal.

Blood and bone marrow samples were collected at regular time intervals up to 1 year posttransplantation and analyzed by PCR and Southern blot for vector sequences. Colony-forming units-granulocyte/macrophage (CFU-GM) and burst-forming units-erythroid (BFU-E) from G418-containing as well as G418-free media were also analyzed by PCR to search for the genomic presence of the *neo* gene, and positively marked cells were subjected to inverse PCR analysis for flanking sequence identification.

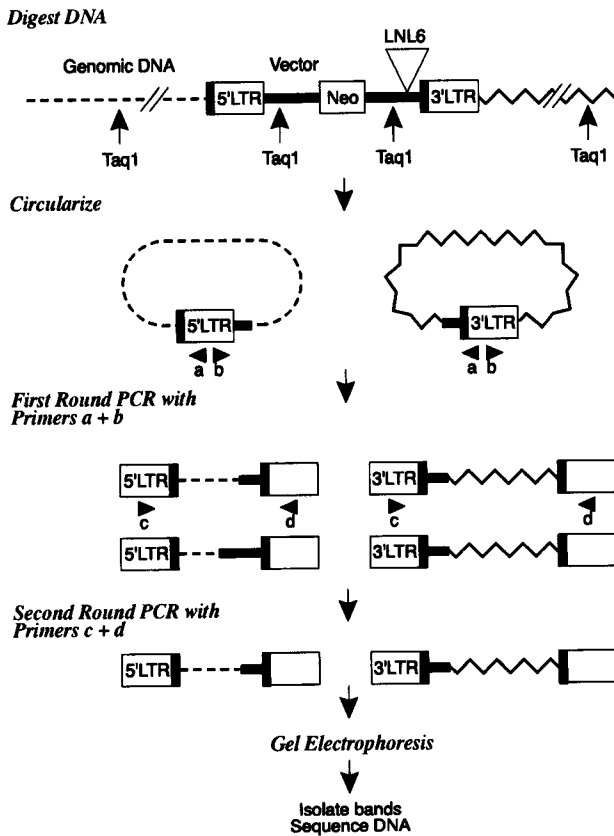
### **Inverse PCR for Insertion Analysis**

Colonies containing 500–1000 cells were plucked, and genomic DNA was isolated as previously described.<sup>2</sup> The DNA was cut with *TaqI* and self-ligated by the addition of T4 ligase. The first round of amplification of circularized DNA was performed with the primers INVa and INVb. Nested PCR was then done on the amplified product with the primers INVc and INVd. The resulting PCR products were electrophoresed on a 2% gel, and the corresponding PCR product bands were excised. DNA from the excised bands was recovered and sequenced (Figure 2).

## **RESULTS**

### **Experimental Design**

Our studies have relied on the rhesus competitive repopulation model, which allows the use of 1 animal to test the engraftment of 2 (or more) populations of transduced stem and progenitor cells. In a non-inbred animal, individual differences in PB stem cell mobilization or other variables could make comparison of results in small groups of individual animals misleading. The competitive repopulation design remedies this problem. In this model, purified progenitors from an individual animal were split into 2 aliquots and transduced with either LNL6 or G1Na, 2 vectors containing an identical neomycin phosphotransferase gene that are distinguishable by differences in the vector backbones. The aliquots were then cultured under different conditions and infused back into the same animal. At regular intervals up to a year posttransplant, peripheral blood and bone marrow samples were obtained for analysis. Lymphocyte and granulocyte fractions were also isolated from the blood for analysis by semiquantitative PCR. Marrow samples were grown in G418-containing or G418-free media, and percentage engraftment by genetically modified cells was calculated from colony PCR

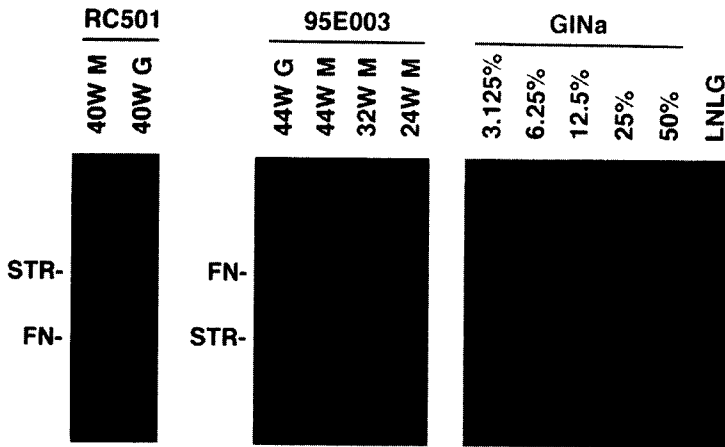


**Figure 2.** DNA analysis by inverse polymerase chain reaction (PCR). Cellular DNA containing integrated provirus was extracted and digested using TaqI. The long terminal repeat (LTR)-containing fragments were self-ligated and amplified using nested, LTR-specific primers in an inverse PCR technique. DNA was electrophoresed, and bands were isolated, cloned, and sequenced to identify unique flanking sequences.

analysis. G418-resistant CFU-GM as well as BFU-E colonies were then analyzed by means of PCR and inverse PCR to confirm engraftment quantification and identify individual transduced clones.

### Detection of Transduced PB Progenitor Engraftment

In 1 cohort of 4 animals that compared PB progenitors expanded ex vivo after transduction to progenitors transduced and not further expanded, transduction in the presence of cytokines IL-3, IL-6, and SCF led to only 0.01% or 1/10,000 of circulating PB progenitor cells containing the vector. Moreover, marking from



**Figure 3.** Engraftment quantification by Southern blot. DNA samples from peripheral blood mononuclear cells and granulocytes derived from animals numbered RC501 and 95E003 were isolated at regular intervals, as indicated by the posttransplant week number in this figure, and analyzed by Southern blot for GINa proviral DNA content. The hematopoietic contribution of 2 aliquots of progenitor cells transduced with support from fibronectin fragment CH-296 (FN) or autologous stroma (STR) was thereby quantified and found to be equivalent in 2 animals.

transduced cells in the cohort that had not undergone ex vivo expansion outnumbered marked cells that had been expanded by a broad margin.

FL and autologous stroma (STR) were then both tested as additions to transduction media in another cohort to investigate the reported ability of FL to stimulate division in primitive hematopoietic cells. Ex vivo expanded cells cultured in the presence of IL-3/IL-6/SCF/FL exhibited an even greater relative defect compared with nonexpanded cells with respect to engraftment, becoming completely undetectable by PCR in some animals. Conversely, nonexpanded cells engrafted at levels as high as 1% long term (vs. the 0.01% obtained without FL). The addition of STR to transductions already supplemented with FL resulted in nonexpanded cells achieving yet better engraftment, stabilizing at >10%.<sup>4</sup> Later experiments demonstrated that fibronectin fragment CH-296 (FN) and STR led to similar levels of engraftment that stabilized at the clinically useful levels of 11% to 20% by 48 weeks.<sup>2</sup> These engraftment percentages represented a significant increase, up to 3 logs, over the extremely low levels of engraftment seen in early clinical marking trials and prior primate studies.

Southern blotting was employed to verify PCR-based quantification of engraftment and made evident that ~10% marking was present in both mononuclear cells and granulocyte fractions overall, with an equivalent contri-



bution by the fractions supported by either STF or FN (Figure 3). No benefit could be ascribed to the replacement of IL-3 and IL-6 by MGDF.<sup>2</sup>

### Clonal Tracking by Inverse PCR

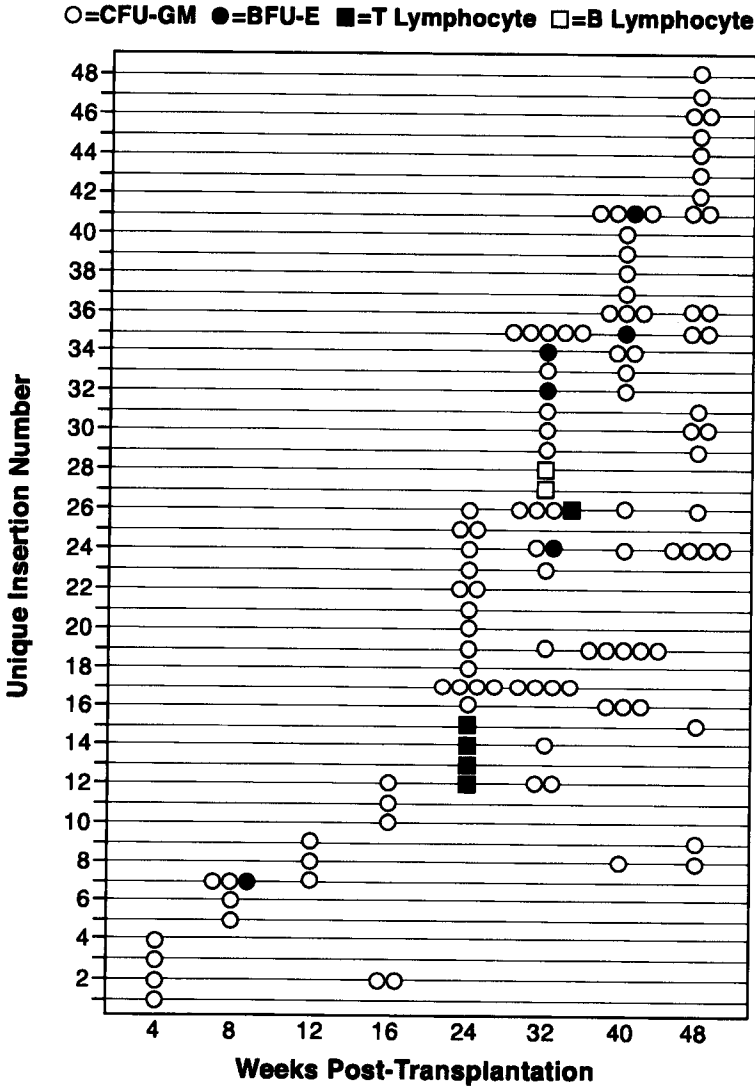
Given the relatively high-level long-term marking, inverse PCR was pursued to determine the complexity of the contribution of transduced PB progenitors to the various hematopoietic cell lineages.

Two hundred thirty-eight well-defined CFU-GM and BFU-E colonies were obtained from 1 animal (termed animal 1 for our discussion) and 292 from another (animal 2) by plating PB progenitor cells in G418-containing media at regular time intervals posttransplantation. Inverse PCR was performed on those colonies, and 75 and 111 colonies from each animal yielded distinct bands. Their DNA was subsequently sequenced. In animal 1, 35 unique provirus-flanking sequences were identified among these clonal progenitors, and 12 of the 35 appeared at 2 or more time points. In animal 2, 44 unique sequences were identified, of which 20 appeared at multiple time points. Furthermore, several identical flanking sequences were recognized to be present in both myeloid and erythroid colonies in both animals. Analysis of lymphoid cells following isolation of T and B cells similarly identified numerous unique flanking sequences, some of which were shared with cells of myeloid and/or erythroid lineage. Data from myeloid, erythroid, and lymphoid cells derived from animal 2 are presented in Figure 4.<sup>5</sup>

## DISCUSSION

Optimization of hematopoietic gene stem cell transfer using retroviral vectors for clinical treatment of genetic diseases such as sickle cell anemia, cancer, and inborn errors of metabolism has been the subject of intensive scientific labors for more than 10 years. Early studies demonstrated successful transduction of murine stem cells, and human peripheral blood progenitors have similarly proven themselves to be amenable to *in vitro* transduction. The undertaking of clinical, *in vivo* human gene transfer, however, has been much more daunting, as fewer than 1 in  $1 \times 10^6$  circulating transduced cells were seen *in vivo* in early marking and therapeutic trials.<sup>1</sup> Although many genetic diseases can be successfully treated with 5%–20% engraftment by transduced stem cells and their progeny, such pioneering *in vivo* human studies undershot those values by a broad margin. The obvious inconsistency between the murine model and human clinical realities necessitated the pursuit of better models.

A nonhuman primate, the rhesus macaque, was selected as a model for several key reasons. It is phylogenetically closely related to humans, many of the growth factors and other reagents required in rhesus stem cell transduction are the same as



**Figure 4.** Clonal analysis of hematopoietic cells. Isolated colony-forming units-granulocyte/macrophage (CFU-GM) and burst-forming units–erythroid (BFU-E) colonies underwent DNA extraction, and that DNA was processed by inverse polymerase chain reaction for the identification of unique, long terminal repeat–flanking genomic sequences and hematopoietic clonality. Each sequence identified was given a number as indicated on the y-axis. The results from 2 animals, one of whose is depicted here, demonstrate the presence of identical sequences in cells of different hematopoietic lineages. Further, the persistence of several sequences over the course of the year is evident as well.

those used in humans, human and rhesus hematopoietic demands are similar, and retroviral cell surface receptor distribution on rhesus cells is similar to that found in humans. All in all, such similarities, in conjunction with the fact that the rhesus can be easily bred and housed in captivity, suggested to us that the rhesus would be a well-suited model for investigating hematopoietic stem cell-based gene transfer methods in humans.

The rhesus competitive repopulation model was employed to study transduction conditions that would be required for the preservation of engraftment capacity, because loss of that capacity was suspected in human clinical trials. Early experiments done primarily to explore the possibility of stem cell *ex vivo* expansion, comparing the multicytokine combination of IL-3, IL-6, and SCF with the same combination plus FL demonstrated that the addition of FL during an initial brief transduction period resulted in improved engraftment by genetically modified cells. Cocultivation with autologous stroma further increased engraftment to the clinically relevant range of ~10% of circulating cells. *Ex vivo* expansion posttransduction, however, was found to be detrimental under all experimental conditions tested despite marked increases in the total number of genetically modified cells or committed progenitors infused. In some animals, in fact, a contribution by expanded marked cells to engraftment was not detectable. Overall, these results suggested that expansion of peripheral blood stem cells is feasible *ex vivo*, but their contribution to short- and long-term engraftment is markedly impaired by such expansion. Nevertheless, a brief initial transduction period with certain cytokines such as FL in the presence of autologous stroma was found to facilitate engraftment with marked cells at levels that were encouraging for future clinical application.<sup>4</sup>

Concurrent work in baboons shed further light on transduction protocols by way of the discovery that bone marrow cells transduced in flasks coated with FN achieved higher engraftment levels than cells cultured in control bovine serum antigen-coated flasks or those cocultivated with vector-producing cells.<sup>6</sup>

Our efforts then turned to consolidating the various assertions regarding transduction conditions made in several studies into an optimal stem cell transduction protocol with potential clinical utility. Again applying the rhesus competitive repopulation model, we first evaluated the substitution of FN-coated flasks for STR cocultivation during transduction, given the very laborious, time-intensive nature of cultivating STR and its therefore poor suitability for clinical application. Transduction for 96 hours with either FN or STR resulted in similar *in vivo* marking levels as detected by PCR and Southern blotting, indicating that FN could replace STR. We went on to address whether the detrimental effect on engraftment could be ascribed to the presence of IL-3 in cytokine combinations and whether earlier-acting cytokines such as MGDF and FL would more effectively facilitate engraftment, as had been suggested in other studies. Seventy-two hours of

cultivation in the presence of either cytokine combination led to engraftment that typically stabilized between 1 and 10%, with no significant difference between the combinations. However, the 72-hour transduction was found to be inferior to the 96-hour transduction period previously employed.<sup>2</sup>

The high engraftment of genetically modified cells allowed direct tracking of individual cells posttransplantation based on the unique insertion sites of a retroviral vector. Some earlier work in mice using direct retroviral tagging suggested a clonal succession model, which purported that at any one moment only a select few progenitors contribute to hematopoiesis and that the contribution of any individual stem cell is of limited duration. Further, those experiments indicated that murine hematopoiesis is oligoclonal,<sup>7</sup> which boded poorly for human gene transfer.

To explore these issues in the rhesus, an animal more closely related to humans, we analyzed 2 animals transplanted with retrovirally tagged cells, using inverse PCR to identify specific genomic sequences flanking retroviral integration sites. Because retroviral proviruses integrate semirandomly, the genomic flanking DNA would be expected to be unique for each transduced progenitor and its progeny. We observed that certain colonies of both myeloid and erythroid lineage derived from PB progenitors collected at regular intervals over 1 year contained identical integration sites, which indicated that they were derived from the same clone. Lymphoid cells also analyzed by inverse PCR were likewise found to contain unique sequences, some of which matched those found in myeloid or erythroid cells or both. From those observations, we were able to draw the conclusion that the transduced PB progenitors were capable of giving rise to cells of multiple hematopoietic lineages and served at least practically as true primitive hematopoietic stem cells.<sup>5</sup> X-inactivation studies have suggested that transplanted hematopoietic progenitors can give rise to multiple hematopoietic lineages in humans as well.<sup>8</sup>

Our data from that clonal tracking study additionally allowed us to estimate the total number of stem cells contributing to hematopoiesis over the first year. In animal 2, the overall level of gene marking was estimated by Southern blot and PCR performed on individual CFUs, and the 44 unique insertion sequences found were estimated to approximate 5% of the total gene marking. In other words, the hematopoietic contribution of transduced cells comprised ~5% of all hematopoiesis occurring in that animal over the course of that year. Using those values within a mathematical model known as capture and release,<sup>9</sup> we could estimate the total number of hematopoietic stem cells actively contributing to hematopoiesis. Analyzing the number of recaptured clones over the year (indicated by repeats in unique sequences at different time points), we estimated that 5 to 44 clones ( $\pm 1$  SD) were hematopoietically active in animal 2, and 8 to 60 in animal 1, at any one time point. The number of transduced PB progenitor cells we originally infused into each animal following conditioning was ~20 million, and CD34<sup>+</sup> cells are known to comprise ~1% of the total bone marrow mononuclear cell compartment. Thus,

our estimation was that 5 cells per  $10^7$  mononuclear cells were hematopoietically active over the course of the first year, or a minimum of 1000 clones.<sup>5</sup> These numbers concur with results obtained by means of a completely different mathematical model in the cat, a large animal with similar hematopoietic demand,<sup>10</sup> as well as results obtained by an alternate insertion site analysis technique (C. von Kalle, data presented in these proceedings). Absolute claims of primate hematopoietic polyclonality cannot yet be made, as the kinetics of primate hematopoiesis extend over years and will require longer-term investigation, but the indirect evidence provided from these various sources, indicating an active hematopoietic stem cell population of >1000 cells, substantiates the case for hematopoietic polyclonality in large animals.

Despite these recent advances in PB progenitor transduction and transplantation, however, immediate clinical utility of these protocols is hampered by the toxicities associated with the myeloablative conditioning employed in these studies. Although clinically relevant engraftment of genetically modified cells would be predicted in humans using the optimized methods after myeloablative conditioning, the risks of such conditioning are not justifiable in the experimental setting of nonmalignant disease. In mice, hematopoietic engraftment without conditioning is achievable, but requires prohibitively high stem cell doses.<sup>11</sup> Low-dose irradiation is sufficient to allow engraftment and expression of foreign transgenes in the murine model,<sup>12</sup> and studies in the nonhuman primate suggest that moderate irradiation doses may suffice for low-level engraftment of genetically modified cells.<sup>13,14</sup> The further extension of studies focused on the development of nonmyeloablative conditioning regimens with low toxicity in large animals, with the aim of reaching similar or higher levels of engraftment of genetically modified cells to those in the myeloablative setting, will be required before embarking on clinical trials, at least for disorders where no selective advantage is conferred on the successfully transduced cells.

Our work has therefore consisted of optimizing conditions and techniques for efficient transduction of PB stem cells, and using those techniques to bolster engraftment into a detectable and clinically relevant range. High-level engraftment has subsequently enabled us to more thoroughly question the clonality of cells derived from transduced PB stem cells, as well as to characterize these progenitors' ability to contribute to hematopoiesis over the short and long term. Our choice of the rhesus macaque was made with the intention of surmounting past inconsistencies arising from extrapolating results obtained in the murine model as well as various human *in vitro* models to humans, by working with a more closely related nonhuman primate model to develop clinically feasible transduction methods. Such methods could be used for the treatment of a broad spectrum of heritable human diseases, such as sickle cell anemia, as well as other nonheritable diseases with genetic etiologies, such as cancer. The data and discussion provided here serve to

illustrate some of our work that now allows us to reassert the initial claim made almost a decade ago that hematopoietic stem cell gene transfer is indeed a likely possibility for the treatment of genetic disease in the future.

## REFERENCES

1. Dunbar CE, Young NS. Gene marking and gene therapy directed at primary hematopoietic cells. *Curr Opin Hematol* 3:430–437, 1996.
2. Wu T, Kim HJ, Sellers S, et al. Prolonged high-level detection of retrovirally marked hematopoietic cells in nonhuman primates after transduction of CD34<sup>+</sup> progenitors using clinically feasible methods. *Mol Ther* 1:285–293, 2000.
3. Donahue RE, Kirby MR, Metzger ME, et al. Peripheral blood CD34<sup>+</sup> cells differ from bone marrow CD34<sup>+</sup> cells in Thy-1 expression and cell cycle status in nonhuman primates mobilized or not mobilized with granulocyte colony-stimulating factor and/or stem cell factor. *Blood* 87:1644–1653, 1996.
4. Tisdale JF, Hanazono Y, Sellers SE, et al. Ex vivo expansion of genetically marked rhesus peripheral blood progenitor cells results in diminished long-term repopulating ability. *Blood* 92:1131–1141, 1998.
5. Kim HJ, Tisdale JF, Wu T, et al. Many multipotential gene-marked progenitor or stem cell clones contribute to hematopoiesis in nonhuman primates. *Blood* 96:1–8, 2000.
6. Kiem HP, Andrews RG, Morris J, et al. Improved gene transfer into baboon marrow repopulating cells using recombinant human fibronectin fragment CH-296 in combination with interleukin-6, stem cell factor, flt-3 ligand, and megakaryocyte growth and development factor. *Blood* 92:1878–1886, 1998.
7. Capel B, Hawley R, Covarrubias L, Hawley T, Mintz B. Clonal contributions of small numbers of retrovirally marked hematopoietic stem cells engrafted in unirradiated neonatal W/W<sup>v</sup> mice. *Proc Natl Acad Sci U S A* 86:4564–4568, 1989.
8. Prchal JT, Prchal JF, Belickova M, et al. Clonal stability of blood cell lineages indicated by x-chromosomal transcriptional polymorphism. *J Exp Med* 183:561–567, 1996.
9. Bishop YMM, Fienberg SE, Holland PW. *Discrete Multivariate Analysis: Theory and Practice*. Cambridge, MA: MIT Press, 1975.
10. Abkowitz JC, Caitlin SN, Guttorp P. Evidence that hematopoiesis may be a stochastic process in vivo. *Nat Med* 2:190–197, 1996.
11. Stewart FM, Crittenden RB, Lowry PA, Pearson-White S, Quesenberry PJ. Long-term engraftment of normal and post-5-fluorouracil murine marrow into normal nonmyeloablated mice. *Blood* 81:2566–2571, 1993.
12. Giri N, Kang E, Wu T, et al. The in vivo persistence of genetically modified progenitors is not limited by the expression of the *neo* gene product in the fully or minimally myeloablated setting. *Blood* 1764 (Suppl), 1999.
13. Huhn RD, Tisdale JF, Agricola B, et al. Retroviral marking and transplantation of rhesus hematopoietic cells by nonmyeloablative conditioning. *Hum Gene Ther* 10:1783–1790, 1999.
14. Rosenzweig M, MacVittie TJ, Harper D, et al. Efficient and durable gene marking of hematopoietic progenitor cells in nonhuman primates after nonablative conditioning. *Blood* 94:2271–2286, 1999.

# The Clonal Activity of Transduced Autologous Repopulating Progenitor Cells

**Manfred Schmidt, Philipp Zickler, Gesa Hoffmann,  
Manuela Wissler, Hanno Glimm, Tong Wu, John Tisdale,  
Hyeoung Kim, Cynthia Dunbar, Christof von Kalle**

*Department of Internal Medicine (M.S., P.Z., G.H., M.W., H.G., C.v.K.),  
University of Freiburg, Freiburg, Germany; Hematology Branch  
(T.W., H.K., C.D.), National Heart, Lung, and Blood Institute,  
National Institutes of Health; Molecular and Clinical Hematology Branch (J.T.),  
National Institute of Diabetes and Digestive and Kidney Diseases,  
National Institutes of Health, Bethesda, Maryland*

## ABSTRACT

The semi-random nature of retroviral integration introduces a marker in the form of a genomic/proviral fusion sequence into the cellular genome unique to each transduced cell and its clonal progeny. Detection of these fusion sequences with high sensitivity can be used to track the clonal contributions of individual, marked hematopoietic progenitor cells in vivo. Our data demonstrate that the marked hematopoiesis in this transplantation model is repopulated by polyclonal, long-lived (>19 months) progenitor cell clones and strongly suggest that the retroviral transduction occurs into a pluripotent cell that contributes to both myeloid and lymphoid lineages.

## INTRODUCTION

Gene transfer into hematopoietic stem cells can establish the presence and expression of a therapeutic gene in a large number of progeny leukocytes, possibly for the lifetime of the recipient. Once this transfer is accomplished efficiently, it will enable the therapy of a number of inherited and acquired genetic diseases that directly affect or can be supplemented by the blood-forming system.

To achieve reliable transfer of the gene of interest to multiple generations of progeny cells, most trials on gene transfer into hematopoietic stem cells have been conducted with murine leukemia virus-derived retroviral vector systems. Their advantages include a high transduction efficiency, unsurpassed biosafety to date, and inherent genetic stability. A major drawback of retroviral vectors has been their

dependence on cell division, which is required for the nuclear entry of the preintegration complex before genomic integration. Recently, new culture conditions have been developed in simian hematopoietic stem cells that result in very efficient retroviral gene transfer of ex vivo repopulating hematopoietic stem cells.<sup>1,2</sup> Exciting progress has also been made with new generations of lentivirus-derived vector systems that do not require cell cycling for efficient integration.<sup>3</sup>

In humans, the first clinical application of stable gene transfer by retrovirus vectors has been the gene marking of ex vivo cultured autologous stem cell transplants. This approach has been based on the rationale that ex vivo culture in the presence of hematopoietic growth factors before transplantation can potentially deplete tumor cells from autologous hematopoietic stem cells. Gene-marking by adding retrovirus during this ex vivo culture can be used to track the in vivo activity of nonmalignant and malignant stem cells derived from such transplants by polymerase chain reaction (PCR) analysis of peripheral and other blood cell samples.

Pioneering clinical retroviral marking trials have demonstrated that repopulating hematopoietic cells can be transduced at low efficiency, and that in most entities tested, the autologous transplants contained malignant cells at the time of transplant.<sup>4</sup> We are currently performing a retroviral gene-marking trial intended to learn more about the therapy for chronic myeloid leukemia patients. It applies several improvements of the retroviral gene transfer strategy compared with first-generation trials, using serum-free media, long-term exposure, different growth factors, and 3 purging procedures to purify the transplanted cells (early apheresis, subselection of CD34<sup>+</sup>/DR<sup>low</sup> cells, subject to availability, and extended 5-day serum-free ex vivo culture). Retroviral gene transfer into normal and malignant repopulating stem cells is assessed.

In model systems where gene transfer into stem cells could be established, new tools have emerged that extend our analytical capability to look at the in vivo clonal activity of hematopoietic stem cells on the molecular level. This work uses the fact that the localization of retroviral and lentiviral integration into the cellular genome is semi-random. The fusion sequence between the vector and the host genomic sequence is characteristic of each transduced cell, and its clonal progeny and can be used to identify their derivation. Using inverse PCR, Nolte et al.<sup>5</sup> have detected common integration sites in 3 of 24 xenotransplanted BNX mice. This finding demonstrates self-renewal at the level of a pluripotent repopulating human hematopoietic progenitor cell, establishing the first molecular evidence for human stem cell renewal. Kim et al.<sup>6</sup> have used inverse PCR to identify insertion sequences from colony-forming units (CFUs) over a period of 1 year after transplantation of transduced peripheral blood stem cells in a rhesus macaque model (Tisdale et al.<sup>2</sup>). Marrow CFUs were derived from >40 transduced repopulating progenitor cells over this time period.

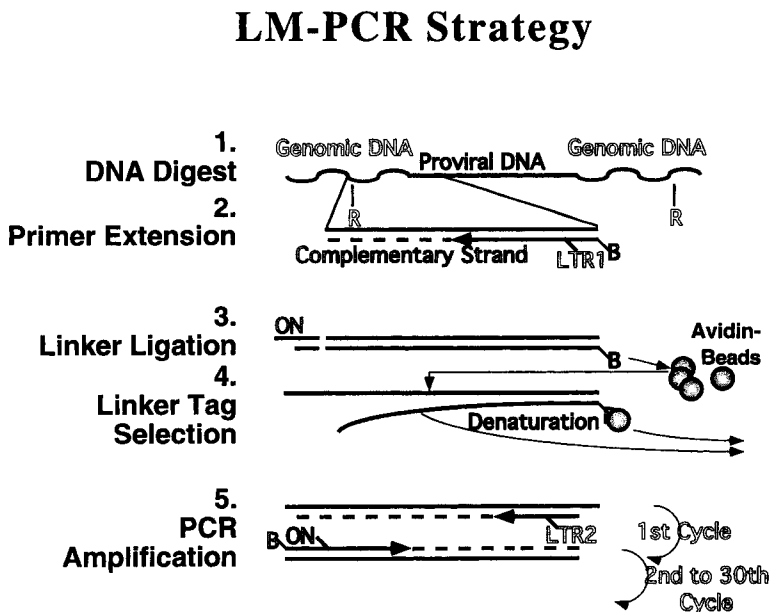


With this newly developed method, we were able to perform clonality analysis directly on peripheral blood cell populations from one of the same animals Kim et al.<sup>6</sup> have studied (collaboration with C. Dunbar and J. Tisdale, National Institutes of Health) and in our clinical retroviral gene-marking trial (Figure 1).

## METHODS

We recently developed a new rapid and reliable PCR technology for the characterization of such unknown flanking DNA sequences. Proviral integration sites can be sequenced directly from peripheral blood samples. The extension primer tag selection ligation-mediated (LM) PCR technique is highly sensitive. It enables sequencing of a proviral integration site even if only 1 per 1000 cells is derived from the same clone.

This technology involves the multistep process of digesting, capturing, ligating, and amplifying the DNA (Figure 1). In brief, target DNA is digested by a specific endonuclease. A primer extension from a vector-specific primer is conducted in the



**Figure 1.** Graphic representation of the sequencing strategy. Note that the primer extension primer and its internally nested analogon are the only required elements of this process that have to be specific for the integrated sequence, rendering the adaptation of this technology to other sequences extremely simple. LM-PCR, ligation-mediated polymerase chain reaction; LTR, long terminal repeat.

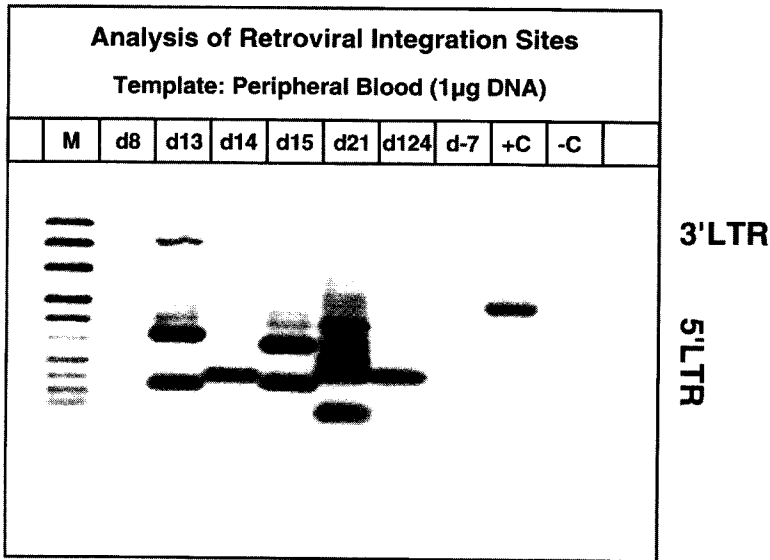
direction of the genomic fusion site. This product is captured on solid phase and ligated to an asymmetric oligonucleotide cassette. The resulting interim product is then amplified by 2 rounds of exponential nested PCR followed, if required, by preparation and bidirectional PCR sequencing.

## RESULTS AND DISCUSSION

### Rhesus Monkey Large Animal Model

Of >70 different 5' integration sites we have sequenced from peripheral blood cells, 35 were identified from purified granulocytes. Two integration loci detected by this method in the peripheral blood 6 and 12 months after transplantation were identical to sequences identified by Kim et al.<sup>5</sup> in CFUs by inverse PCR.

To follow specific clones identified in the 6-month sample over time, we designed conventional PCR primers to span specific integration sites. Of 4 integration clones tested, 3 could be detected again in purified peripheral granulocytes from the same animal 12 months after transplant, ie, 6 months after the original



**Figure 2.** Southern blot of the integration site analysis on patient material within the first year after autologous transplantation of a gene-marked product. Numbers indicate the day after transplantation. +C, positive control of a transduced HeLa cell clone; -C, negative control conducted on nontransduced human cell line DNA; LTR, long terminal repeat; M, molecular weight marker.

clone had been identified. The contribution of these 3 clones to blood formation was studied at 15 different time points within 2 years after transplantation. Molecular evidence for the activity of these clones was detectable in most samples collected on day 42 or later, including those from purified T and B cells. These data strongly suggest that the ex vivo transduction has accomplished gene transfer into repopulating pluripotent stem cells capable of contributing blood cells to the peripheral circulation in multiple lineages and over prolonged periods of time.

### Clinical Marking Study

From the peripheral blood of 1 patient, we have been able to identify multiple PCR products of integration sites (Figure 2). Up to now, 9 of these have been sequenced and identified as integration site sequences. Despite the lower transduction efficiency in the clinical transplantation setting, we are currently attempting to track some of these clones, in a way similar to the approach taken in the large animal model.

### SUMMARY

Our analyses provide molecular evidence for a polyclonal hematologic repopulation after autologous transplantation of blood stem cells. Long-term activity of transduced clones could be detected and was highly likely to be pluripotent. These findings indicate that ex vivo gene transfer can be obtained in the hematopoietic stem cells that contribute to blood formation over extended periods of time.

### REFERENCES

1. Kiem HP, Heyward S, Winkler A, et al. Gene transfer into marrow repopulating cells: comparison between amphotropic and gibbon ape leukemia virus pseudotyped retroviral vectors in a competitive repopulation assay in baboons. *Blood* 11:4638–4645, 1997.
2. Tisdale JF, Hanazono Y, Sellers SE, et al. Ex vivo expansion of genetically marked rhesus peripheral blood progenitor cells results in diminished long-term repopulating ability. *Blood* 4:1131–1141, 1998.
3. Naldini L. Lentiviruses as gene transfer agents for delivery to non-dividing cells [review]. *Curr Opin Biotechnol* 5:457–463, 1998.
4. Dunbar CE, Tisdale J, Yu JM, et al. Transduction of hematopoietic stem cells in humans and in nonhuman primates [review]. *Stem Cells* 15 (Suppl 1):135–139, 1997.
5. Nolte JA, Dao MA, Wells S, Smorgorzewska EM, Kohn DB. Transduction of pluripotent human hematopoietic stem cells demonstrated by clonal analysis after engraftment in immune-deficient mice. *Proc Natl Acad Sci U S A* 2414–2419, 1996.
6. Kim HJ, Tisdale JF, Wu T, et al. Many multipotential gene-marked progenitor or stem cell clones contribute to hematopoiesis in nonhuman primates. *Blood* 96:1–8, 2000.

# **A View of Myelodysplastic Syndrome as an Infectious Disease**

**Azra Raza, Francesca Zorat, Fabiana Nascimben, Suneel Mundle,  
Vilasini Shetty, Poluru Reddy, Krishnan Allampallam, Sairah Alvi,  
Ahmad Shaher, Mona Tareen, Parameswaran Venugopal**

*Rush Cancer Institute, Rush-Presbyterian-St. Luke's Medical Center,  
Chicago, Illinois*

## **ABSTRACT**

Over the last decade, the incidence of myelodysplastic syndrome (MDS) appears to be on the rise, yet little progress has been made in improving therapies for patients with MDS. Growth factors, differentiating agents, and chemotherapy have failed to substantially improve the outcome for most patients. Transplant is potentially curative, but it is an option for <5% of cases, because the disease predominates in the elderly. It is therefore not only timely but essential that the biology of these disorders be aggressively studied to develop better treatment options. Patients with MDS generally present with a variable cytopenia in the blood and a monoclonal, dysplastic, hypercellular bone marrow (BM). A cytokine-induced excessive apoptosis of hematopoietic cells in the BM may account for the cytopenia. Suppression of these cytokines with a consequent attenuation of programmed cell death in the marrow can logically be considered a new therapeutic option. Unfortunately, a plethora of proinflammatory cytokines have been found to be upregulated in the marrow of MDS patients, making it unlikely that each could be individually neutralized. Recognition that tumor necrosis factor (TNF) acts as the proximal initiator of this inflammatory cascade has rendered this ubiquitous protein an excellent therapeutic target. Over the last several years, anticytokine, cytoprotective, and immunosuppressive therapies have been tried with variable success. Despite significant benefit in some patients, all these approaches remain essentially palliative at best. Curative treatment depends on developing a better understanding of the etiologic issues involved. This article summarizes our view of MDS as an inflammatory disease rather than a malignant one. We have developed novel techniques to examine the stromal as well as the parenchymal cells from MDS marrow. The role of DNA and RNA viruses and the unique problems related to proving an association between pathogens and chronic diseases have been discussed at length. Detection of reverse transcriptase activity in the supernatant of

cultured MDS cells provides the first exciting hint that a retrovirus may be involved in some MDS cases.

## INTRODUCTION

Myelodysplastic syndrome is an array of clinically frustrating hematopoietic disorders that are being found to be more biologically complex than previously suspected.<sup>1-3</sup> The variable cytopenias that form the pathognomonic features of the disease do not appear to represent failed marrow function, because intramedullary hematopoietic cells are in a state of heightened proliferation.<sup>4</sup> Rather, as novel recent insights have demonstrated, cytokine-mediated apoptotic death of hematopoietic cells is the likely basis for these quintessential cytopenias.<sup>5-8</sup> In the midst of this excessive proliferation, excessive apoptosis, and enormous upregulation of proinflammatory cytokines in the BM are aggregates of lymphoid and plasma cells, and a significant increase in neoangiogenesis, as well as an increase in the factors that drive the formation of new blood vessels.<sup>9</sup> Finally, the disease is monoclonal.<sup>10</sup> What that implies is a clonal expansion of an early stem cell capable of terminal, albeit dysplastic, differentiation into all lineages. To speculate on possible etiologies for these very peculiar findings, a more detailed examination of some of these features is warranted.

## Apoptosis in MDS

Bone marrow cells belonging to all 3 lineages (myeloid, erythroid, and megakaryocytic) have been found to be apoptotic at every stage of their maturation. Blasts as well as CD34<sup>+</sup> cells show evidence of increased apoptosis, especially when examined in a mixture containing both CD34<sup>+</sup> and CD34<sup>-</sup> cells. When propensity to undergo premature apoptosis is studied in separated cells, CD34<sup>+</sup> cells appear to be indistinguishable between MDS and normal marrow, implying that the signal for apoptosis may reside within the CD34<sup>-</sup> compartment. Whether the primitive hematopoietic stem cells in MDS patients have an increased propensity to undergo premature apoptosis remains undetermined as of now, since several independent studies have provided conflicting data.<sup>11-15</sup> In sections of bone marrow biopsies studied for apoptosis by *in situ* labeling techniques, blasts are generally nonapoptotic. There is also a significant difference in the level of apoptosis between peripheral blood (PB), BM aspirate, and BM biopsies. We and others have demonstrated that biopsies have the highest incidence of apoptosis, making up as much as 75% of the cellular component. On the other hand, BM aspirates have a much lower percentage of apoptotic cells, ~0-5%, and the cells may remain undetected unless unmasked following short-term cultures in complete medium. Finally, cells in PB are actually more resistant to apoptosis than are normal cells.<sup>16</sup>

Despite the different sensitivity toward early death within cells of the 3 different compartments, all cells are descended from the same transformed MDS clone. Cells bearing a spectrum of propensity toward apoptosis, with the most sensitive residing in the biopsy and the most resistant in the circulation, also suggest that the proapoptotic signals are highly concentrated in the marrow biopsies. Because parenchymal cells are easily aspirable, this observation also indicates that proteins initiating programmed cell death may be originating in the marrow stroma, a compartment whose cells are generally nonaspirable in appreciable quantities. What these signals are will be discussed below.

### **Role of Proapoptotic Cytokines**

The excessive cell death in MDS appears to be cytokine mediated. A number of proinflammatory cytokines have been found to be expressed in higher than normal amounts; however, the proximal initiator of this cascade is the ubiquitous tumor necrosis factor.<sup>17-19</sup> Appreciation that TNF may act as the master switch capable of turning the cascade of proinflammatory cytokines on and off has also opened the possibility of using TNF as a therapeutic target. Attempts to neutralize or suppress this upstream cytokine via the use of anti-TNF agents such as pentoxifylline (Enbrel)—and more recently, thalidomide—or the cytoprotective agent amifostine have resulted in improved blood counts in a subset of MDS patients.<sup>20-23</sup> This provides further *in vivo* support for the hypothesis that apoptosis in hematopoietic cells is being mediated by cytokines, particularly TNF. The precise source of these cytokines remains obscure, but because the incidence of apoptosis is the highest in BM biopsies, it is highly likely that stromal or accessory cells are secreting these proteins.

### **Immune Abnormalities in MDS**

In addition to an inflammatory reaction in the marrow, there is increasing evidence that all is not normal with the immune system of MDS patients.<sup>24</sup> There is often a lymphocytopenia in these patients, especially that affecting the CD4 cells. There are aggregates of lymphocytes and plasma cells infiltrating the marrow. These are composed of both T and B cells and have been found to be polyclonal.

### **Cytogenetic Abnormalities in MDS**

Recurrent, nonrandom karyotypic abnormalities in MDS include those affecting chromosomes 5, 7, 8, 20, and Y.<sup>25</sup> With the exception of trisomy 8, all others involve loss of part or a whole chromosome. By sorting CD34<sup>+</sup> cells into further subsets, we have found that karyotypic abnormalities affect even the earliest stem

cells. Interestingly, both the cytogenetically normal and abnormal cells are found to descend from the transformed MDS parent cell, implying that cytogenetic abnormalities are not causally related but represent derivative populations of an evolving clone.

### **Etiology of MDS**

Given the complicated biology described above for MDS, it is difficult to envision a simple explanation for the cytopenias that epitomize the clinical syndrome. The marrow biopsy appears to be the site of an inflammatory reaction, resulting in a peculiar cytopathic effect on the nonlymphoid cellular compartment, particularly the erythroid series. Some cases of MDS present with excess blasts, whereas in others there is a gradual increase in immature cells—although sudden transformation of refractory anemias to acute leukemia has been described. On the whole, there is an increased risk of leukemic transformation in MDS, the risk and rapidity being relatively proportional to the percentage of blasts at presentation. Excessive proliferation—matched by an excessive cytokine-induced apoptosis as well as increased amounts of proapoptotic cytokines in the background of a hypercellular, monoclonal marrow with an intrinsic immunologic defect in the patient—suggests that MDS may not be a malignant disease, but is rather an inflammatory process. In fact, we hypothesized that MDS begins as a viral disease. Now we have some circumstantial evidence to support that hypothesis and new leads to pursue, leads that should provide incontrovertible proof for our hypothesis.

### **Concurrence Across Dysplastic States**

Because nature is highly parsimonious as a rule, it is likely that a number of dysplastic tissues in the body follow the same algorithm. A comparison between the biologic peculiarities of dysplasias affecting the bone marrow, cervix, liver cells, and stomach cells shows extraordinary similarities.<sup>26</sup> All 4 dysplastic states are characterized by increased proliferation, increased apoptosis, elevated levels of proapoptotic cytokines/genes (*p53*), and attenuated antiapoptotic genes (*bcl-2*). All dysplastic tissues are also monoclonal, and at least in the case of cervical dysplasia, it has been demonstrated that 2 dysplastic areas separated by normal tissue are both monoclonal, whereas the intermediate normal tissue is polyclonal. Interestingly, the 2 monoclonal tissues may be descended from different parent cells, implying that the etiology could very well be outside the dysplastic cells. In fact, it is possible that the dysplastic morphology merely represents an adverse microenvironment resulting in 1 or 2 cells acquiring a growth advantage, leading to their clonal expansion and an eventual monoclonal state. If this is true, then the role of

the microenvironment must be intensely studied. In addition, there is a 30% chance of a frank malignancy arising in the background of the dysplastic tissue in every dysplastic state. Finally, cervical, liver cell, and stomach cell dysplasias have all been associated with an infectious pathology. The human papilloma viruses (HPV) as well as human herpesviruses (HHV) 1 and 4 have been linked to cervical dysplasia; hepatitis B and C viruses (HBV and HCV) with liver cell dysplasia; and a bacterium, *Helicobacter pylori*, with stomach cell dysplasia. It is time that we seriously consider the possibility of a pathogen being responsible for marrow dysplasia as well.<sup>27,28</sup>

### Which Virus?

If MDS is indeed an infectious disease, then the virus involved may be a recently acquired new virus or one that has been living in symbiosis with the BM cells.

**Reactivated Viruses.** A compromised immune function, a second virus infection, or toxic/chemical exposure could be responsible for reactivation of a resting virus from an inert, quiescent state to one of active proliferation. This is not a situation unique to the marrow. A prominent example is that of varicella virus causing chicken pox. After producing a self-limited, brief illness—mostly in children—the clinical signs and symptoms subside, but the virus never leaves the body, assuming permanent residence in the neural ganglia. Yet, only 1% of those struck with chicken pox in childhood develop shingles as adults due to its reactivation from the neural ganglia. Depending on whether the host is immunocompetent or immunocompromised, this reactivation can cause myelitis, small vessel arteritis, or a large vessel encephalitis. It is worth noting here that only some of the diseases caused by the reactivated virus are contagious in nature, underscoring the point that a lack of epidemiologic evidence for clustering of MDS cases does not necessarily rule out an infectious pathology. Candidate viruses that have been known to acquire latency in bone marrow cells include several of the HHVs, such as HHV-4 (Epstein-Barr virus [EBV]), HHV-5 (cytomegalovirus [CMV]), and the recently characterized HHV-6, -7, and -8. All of these are capable of causing a variety of diseases not only upon direct infection, but also upon reactivation from a quiescent state. Their role in producing variegated pathology, especially in the hematopoietic cells, has only recently been recognized and is being intensely investigated. In our studies of cultured BM stromal cells from MDS patients, we have found evidence for expression of activation marker genes for both EBV and CMV in 10–50% of cases.<sup>29</sup> It is not unusual to see a number of latent viruses become activated in immunocompromised patients, as has been shown in the case of acquired immunodeficiency syndrome (AIDS) patients. Whether the activated



herpesviruses in MDS marrow represent an etiologic association or merely an enormously immunosuppressed state of the host remains to be determined. Because there is a cytopathic effect in the nonlymphoid cells in MDS patients, and the herpesviruses are lymphotropic, if these agents are involved in etiology, then the apoptosis in nonlymphoid cells may merely represent innocent bystander cell death. The role of retroviruses in this latency-reactivation type pathology cannot be ignored, because human T-cell leukemia virus (HTLV)-1 is known to cause not only leukemia but also a neurologic disease called tropical spastic paraparesis (TSP).<sup>30</sup> In this latter disease, live HTLV-1 has been demonstrated in marrow monocytes. Activated HTLV-1 has also been found in AIDS patients, so much so that in the early 1980s, it was a serious contender for the cause of the disease and may still be a possible cofactor with human immunodeficiency virus (HIV) in causing AIDS. It is not entirely improbable for a lymphotropic virus such as HTLV to be responsible for a myeloid disease of the marrow, and its role also needs to be vigorously tested in marrow disorders, including MDS.

**A New Virus.** Only 4 retroviruses have so far been associated with human diseases, HTLV-1 and -2 and HIV-1 and -2. The reason is clearly not that no other retroviruses cause human diseases; rather, it lies with the difficulty in isolating these pathogens with previously available techniques. With the surge in new and sophisticated technology, the time is ripe for the search to restart. It is not unlikely that a slow-growing lentivirus, acting alone or in the company of cofactors, is responsible for the chronic inflammatory reaction in the marrow of MDS patients.

### Which Cell?

So far, most biologic studies in MDS have concentrated on examining parenchymal cells obtained from BM aspirates. It is highly probable that such a virus is missed because of its sanctuary in the stromal cells. After all, it has been demonstrated that herpetic infection of a few dendritic/stromal cells in myeloma can dramatically alter the cytokine milieu in the marrow and provide growth advantage to cells of lymphoid origin.<sup>31</sup> Unfortunately, there are very few studies directed at the stroma in MDS patients, for the obvious reason that bone marrow cells have been difficult to culture *in vitro*, since they undergo rapid apoptosis. Using modified techniques developed recently, much success has been achieved in growing bone marrow stromal cells in long-term *in vitro* cultures. Supernatants from these cultures have begun to yield interesting new biological information as reverse transcriptase activity has been demonstrated in the cultured stromal layers from some MDS cases. These data appear to implicate a retrovirus either as a sole causative agent or as a cofactor in at least a subset of MDS cases. These studies need to be vigorously pursued for confirmation.

## THE PROBLEM OF ASSOCIATING VIRUSES AS ETIOLOGIC AGENTS FOR CANCERS

There are several reasons it has not been easy to demonstrate the role of viruses in human malignancies despite morphologic proof of virus-like particles and genetic evidence for activated viral genes. In summary:

- There is usually an extended lag between the actual viral infection and the appearance of a malignancy. In the case of HTLV, a vertical transmission of the virus from mother to baby has been clearly demonstrated, yet the leukemia associated with this agent does not become clinically apparent for decades.
- As a consequence of the above, it is clear that cofactors must play a critical role in the carcinogenic process, some of which have been graphically illustrated recently. The case of HIV and HHV-8 acting in concert to cause a higher incidence of Kaposi's sarcoma (KS) in patients with AIDS is a prime example. The coactivation of several pathogens simultaneously has been shown to cause more profound disease, as seen in HIV and AIDS, in the presence of other sexually transmitted diseases. Because of patients who have remained positive for HIV without developing AIDS for more than a decade, the need for a cofactor in both known retroviruses has been further underscored. In fact, much debate surrounds the question of what precisely causes the clinical syndrome of AIDS. It is the view of several respected researchers that without the simultaneous infection of HIV-positive patients with other pathogens such as mycoplasma, the syndrome of AIDS remains clinically silent. The same may be true for cancers and infectious agents. In a way, the situation is analogous to a safety deposit box where 2 keys need to be turned simultaneously to open the lock. Especially because of the abundance of micro-organisms in our midst, it is highly probable that ingenious strategies have materialized over millennia of evolutionary pressures to best the ever-escalating battle between host and pathogen. Thus, the need for cofactors; otherwise, cancer would be far too common a disease.
- Cancers do not follow the rules of quotidian infectious diseases, in that very rarely, if ever, has clustering of cases been demonstrated via large-scale epidemiologic studies. Gastric ulcer does not show clustering, but does that mean *H. pylori* is not an etiologic agent?
- Pathogens provide only 1 step in a complex, multistep pathology that eventually converts a normal cell into a frankly malignant one. Frequently, therefore, it is a hit-and-run situation, where the virus may have been responsible for switching on a cellular process that, following a series of subsequent events, snowballs into a life of its own, with the final product only remotely connected with the proximal initiator. Associating the end

organ damage with the master initiator is extremely difficult. This also has therapeutic implications, since cessation of smoking fails to cure lung cancer for this reason despite the proved association between the two.

- Recent demonstration of the association between *H. pylori* and stomach cancer and HBV or HCV and hepatocellular carcinoma provides yet another baffling variable, since it appears that pathogens causing cancer could be familiar, common ones. Why these common pathogens produce pathology in a selected few once again reinforces the requirement for multiple factors in the complex process of carcinogenesis.

### THERAPIES PAST AND PRESENT

Myelodysplastic syndrome is a group of bone marrow disorders marked by monoclonal, dysplastic hematopoiesis with or without an excess of blasts, a hyperactive marrow filled with rapidly proliferating and dying cells, and a plethora of proinflammatory cytokines. Clinically, this translates into ever-worsening cytopenias and transformation toward acute leukemia, predominantly in those individuals who present with an excess of blasts. The universally grim nature of this illness can best be appreciated by the fact that the median survival for MDS patients is only 2 years. Given the highly complex biology described above, it is no surprise that therapeutic approaches have been many and varied, and most of them have failed to produce the desired benefit. Standard treatment of MDS, as a result, continues to be supportive care. The only curative therapy is transplantation,<sup>32</sup> but that remains an option for <5% of patients. Palliative measures directed at inducing differentiation (vitamins), hyperproliferation (growth factors), and cell kill (chemotherapy) have failed to provide long-term benefit for most patients. Recent therapeutic strategies have been directed at reducing the cytokine-induced death of hematopoietic cells by neutralizing the cytokine directly (TNF receptor Enbrel) or indirectly (pentoxifylline, amifostine, thalidomide) or by eliminating the cells producing the cytokines (cyclosporin, antithymocyte globulin [ATG]).<sup>33</sup> Results obtained with these agents appear to be no better than those with previous approaches, producing improved counts in 30%–50% patients for a period of time. In summary, therefore, nontransplant therapies for MDS to date have provided only palliation. Future trials need to judiciously combine these agents for better results. Any hope for cure must take into account more etiology-related issues, thereby underlining the extreme urgency for aggressive basic research.

### REFERENCES

1. Resegotti L. The nature and natural history of myelodysplasia. *Haematologica* 25:191–204, 1993.
2. Yoshida Y, Stephenson J, Mufti GJ. Myelodysplastic syndromes: from morphology to

- molecular biology, I: classification, natural history and cell biology of myelodysplasia. *Int J Hematol* 57:87–97, 1993.
3. Aul C, Gatterman N, Schneider W. Age-related and other epidemiological aspects of myelodysplastic syndromes. *Br J Haematol* 82:358–367, 1992.
  4. Raza A, Alvi S, Broady-Robinson L, Showel M, et al. Cell cycle kinetic studies in 68 patients with myelodysplastic syndromes following intravenous iodo- and/or bromodeoxyuridine. *Exp Hematol* 25:530–535, 1997.
  5. Yoshida Y. Apoptosis may be the mechanism responsible for the premature intramedullary cell death in myelodysplastic syndromes. *Leukemia* 7:144–146, 1993.
  6. Clark DM, Lampert IA. Apoptosis is a common histopathological finding in myelodysplasia: the correlate of ineffective hematopoiesis. *Leuk Lymphoma* 2:415–418, 1990.
  7. Raza A, Gezer S, Mundle S, Gao XZ, et al. Apoptosis in bone marrow biopsy samples involving stromal and hematopoietic cells in 50 patients with myelodysplastic syndromes. *Blood* 86:268–276, 1995.
  8. Raza A, Mundle S, Shetty V, Alvi S, et al. Novel insights into the biology of myelodysplastic syndromes: excessive apoptosis and the role of cytokines. *Int J Oncol* 8:1257–1264, 1996.
  9. Pruneri G, Berfolini F, Soligo D. Angiogenesis in MDS. *Br J Cancer* 81:1398–1401, 1999.
  10. Janssen JWG, Buschle M, Layton M. Clonal analysis of MDS: evidence of multipotent stem cell origin. *Blood* 73:248–254, 1989.
  11. Mundle M, Venugopa P, Shetty V, Ali A, et al. The relative extent of propensity of CD34<sup>+</sup> vs. CD34<sup>-</sup> cells to undergo apoptosis in myelodysplastic marrows. *Int J Hematol* 69:152–159, 1999.
  12. Rajapaksa R, Ginzton N, Rott LS, Greenberg PL. Altered oncoprotein expression and apoptosis in myelodysplastic syndrome marrow cells. *Blood* 88:4275–4287, 1996.
  13. Parker JE, Fishlock KL, Mijovic A, Pagliuca A, Mufti GJ. Leukemic progression in myelodysplastic syndromes (MDS) is associated with decreased apoptosis and a reduced ration of pro- versus anti-apoptotic Bcl-2 related proteins [abstract]. *Blood* 90:520a, 1997.
  14. Kliche KO, Andreeff M. High expression of phosphatidylserine (PS) in MDS, secondary AML (sAML) and normal progenitors: comparison with primary AML (pAML) [abstract]. *Blood* 90:202a, 1997.
  15. Anzai N, Kawabata H, Hishita T, Yoshida Y, Ueda Y, Okuma M. Ca<sup>2+</sup>/Mg<sup>2+</sup>-dependent endonuclease in marrow CD34 positive and erythroid cells in myelodysplasia. *Leuk Res* 21:731–734, 1997.
  16. Horikawa K, Nakakuma H, Kawaguchi T, et al. Apoptosis resistance of blood cells from patients with paroxysmal nocturnal hemoglobinuria, aplastic anemia and myelodysplastic syndromes. *Blood* 90:2716–2722, 1997.
  17. Mundle SD, Venugopal P, Pandav DV, et al. Indication of an involvement of interleukin-1 $\beta$  converting enzyme (ICE)-like protease in intramedullary apoptotic cell death in the bone marrows of patients with myelodysplastic syndromes (MDS). *Blood* 88:2640–2647, 1996.
  18. Shetty V, Mundle S, Alvi S, et al. Measurement of apoptosis, proliferation and three cytokines in 46 patients with myelodysplastic syndromes. *Leuk Res* 20:891–900, 1996.
  19. Raza A, Gregory SA, Preisler HD. The myelodysplastic syndromes in 1996: complex stem

- cell disorders confounded by dual actions of cytokines. *Leuk Res* 20:881–890, 1996.
20. List AF, Brasfield F, Heaten R. Stimulation of hematopoiesis by amifostine in patients with MDS. *Blood* 90:3364–3369, 1997.
  21. Raza, A, Qawi H, Lisak L, et al. Patients with myelodysplastic syndromes benefit from palliative therapy with amifostine, pentoxifyllin, and ciprofloxacin with or without dexamethasone. *Blood* 95:1580–1587, 1999.
  22. Raza A, Allampallam K, Shetty V, et al. Biologic and clinical response to recombinant human soluble tumor necrosis factor receptor (Enbrel) in patients with myelodysplastic syndromes (MDS) [abstract]. *Blood* 94:171b, 1999. Abstract 3941.
  23. Raza A, Lisak L, Andrews C, et al. Thalidomide produces transfusion independence in patients with long-standing refractory anemias and myelodysplastic syndromes (MDS) [abstract]. *Blood* 94:661a, 1999. Abstract 2935.
  24. Colombat PH, Renoux M, Lamagnere J-P, Renoux G. Immunologic indices in myelodysplastic syndromes. *Cancer* 61:1075–1080, 1988.
  25. Heim S. Cytogenetic findings in primary and secondary MDS [review]. *Leuk Res* 16:43–46, 1992.
  26. Raza A. Consilience across evolving dysplasias affecting myeloid, cervical, esophageal, gastric and liver cells: common themes and emerging patterns. *Leuk Res* 24:63–72, 2000.
  27. Raza A. Hypothesis: myelodysplastic syndromes may have a viral etiology. *Int J Hematol* 68:245–256, 1998.
  28. Raza A. The initial transforming event in myelodysplastic syndromes may be viral: the case for cytomegalovirus. *Med Oncol* 15:165–173, 1998.
  29. Mundle S, Mativi BY, Carlidge J, et al. Demonstration of CMV and EBV related mRNA transcripts in myelodysplasia [abstract]. *Blood* 94:107a, 1999. Abstract 470.
  30. Tsujino A, Nakamura T, Nishiura Y, et al. Pentoxifylline down-regulates adhesion molecule expression and inflammatory cytokine production in cultured peripheral blood mononuclear cells from patients with HTLV-1 associated myelopathy. *J Neuro Immunol* 73:191–196, 1997.
  31. Rettig MB, Ma HJ, Vescio RA, et al. Kaposi's sarcoma-associated herpesvirus infection of bone marrow dendritic cells from multiple myeloma patients. *Science* 276:1851–1854, 1997.
  32. Anderson JE, Appelbaum FR, Schoch G, et al. Allogeneic marrow transplantation for refractory anemia: a comparison of two preparative regimens and analysis of prognostic factors. *Blood* 87:51–58, 1996.



# **CHAPTER 7**

## **MINI-TRANSPLANTS**





# **Nonmyeloablative Allografts: From the Laboratory to the Clinic**

**Rainer Storb, Peter A. McSweeney, Brenda M. Sandmaier,  
Richard A. Nash, George Georges, David G. Maloney,  
Arthur Molina, Michael Maris, Ann Woolfrey, Thomas Chauncey,  
Jan M. Zaucha, Karl G. Blume, Judith Shizuru, Dietger Niederwieser**

*Fred Hutchinson Cancer Research Center (R.S., P.A.M., B.M.S., R.A.N.,  
G.G., D.G.M., A.M., J.M.Z.), University of Washington School of Medicine  
(R.S., P.A.M., B.M.S., R.A.N., G.G., D.G.M., M.M., A.W., T.C.),  
Veterans Administration Medical Center (T.C.), Seattle, Washington;  
Stanford University School of Medicine (K.G.B., J.S.), Stanford, California;  
University of Leipzig (D.N.), Leipzig, Germany*

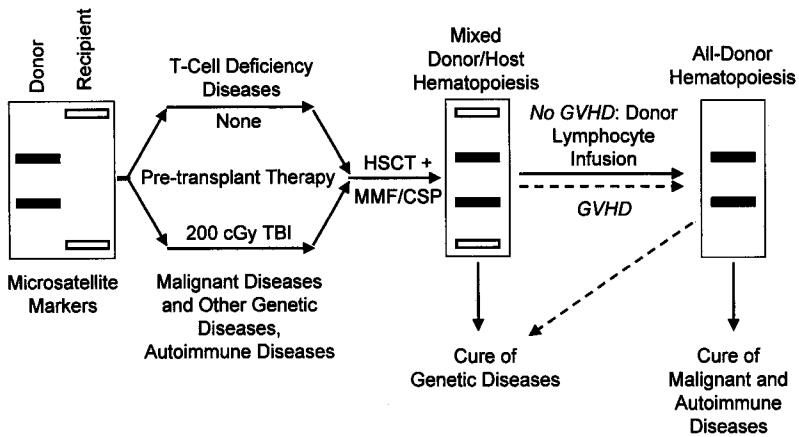
In 1949, Jacobson et al.<sup>1</sup> reported that mice could be protected from the marrow-lethal effects of ionizing total body irradiation (TBI) by shielding their spleens with lead. This finding marked the beginning of the modern era of hematopoietic stem cell transplantation (HSCT). It led to further animal experiments, which showed in 1956 that the radioprotection was effected by transplantable HSCs.<sup>2-4</sup> Further experiments in large random-bred animal species resulted in the development of an HSC transplant schema for human patients with marrow-based diseases, such as leukemias.<sup>5</sup> The schema involved the administration of very high doses of systemic chemoradiation therapy to destroy the patients' underlying diseases, followed by rescue through subsequent infusion of HSCs. The therapy's intensity would be limited only by serious toxicities to nonmarrow organs, for example, gut, lung, heart, and liver.

Most current HSCT approaches are based on the original treatment schema. Even so, at least 2 findings have raised questions about whether the current transplant concepts are universally valid. One is that many hematologic malignancies cannot be wiped out by high-dose therapy, even though it has been intensified to a point at which serious organ toxicities are common.<sup>5,6</sup> The other is that many of the observed cures can be ascribed to immunologic graft-vs.-tumor reactions.<sup>7-10</sup> In fact, donor lymphocyte infusions are now commonly used to reinduce remissions in patients who have relapsed after conventional HSCT.<sup>11,12</sup> The 2 findings, that regimen-related toxicities have limited conventional HSCT to younger patients with good organ function and a better understanding of how to control both host and donor immune functions, have led to a radical rethinking of how allogeneic HSCT might be done in the future. For example, instead of trying

to wipe out tumor cells through intensive and toxic therapy, the HSCT donor's immune cells are used for that purpose, invoking a graft-vs.-tumor effect. Eliminating the high-dose pretransplant therapy from transplant regimens would allow extending HSCT to include patients who are too old or medically infirm to qualify for conventional allotransplants.

The development of the new nonmyeloablative HSCT approach used in Seattle, Stanford, Denver, and Leipzig was firmly based on 2 experimental findings showing that both host-vs.-graft (HVG) and graft-vs.-host (GVH) reactions are mediated by T lymphocytes in the setting of major histocompatibility complex-identical HSCT. This has opened up the possibility of identifying post-transplant immunosuppression that not only controls GVH disease (GVHD) but also reduces HVG residual reactions and, thus, eliminates the need for intensive and potentially organ-toxic pretransplant therapy. Studies in a preclinical canine model enabled us to substitute nonmyelotoxic posttransplant immunosuppression for cytotoxic pretransplant conditioning therapy in a stepwise fashion.<sup>13,14</sup> The new transplant schema evolving from these studies includes some immunosuppression delivered before HSCT to reduce host immune reactivity and a slightly more extended course of immunosuppression administered after transplant, which has the dual purpose of both controlling GVHD and eliminating residual host immune responses. After discontinuation of posttransplant immunosuppression, mutual graft-host tolerance develops, which may become manifest as either stable mixed donor/host or all-donor hematopoietic chimerism.

A well-tolerated and effective transplant regimen in dogs uses a low and nonmyeloablative dose of 200 cGy (given at the very low rate of 7 cGy/minute) TBI before DLA-identical HSCT and the *de novo* purine synthesis inhibitor mycophenolate mofetil (MMF) combined with the T-cell activation blocker cyclosporine (CSP) for 4 and 5 weeks, respectively, after transplant.<sup>14</sup> Successful donor engraftment was also accomplished when dogs were given pretransplant irradiation limited to cervical, thoracic, and upper abdominal lymph nodes instead of TBI.<sup>15</sup> In these dogs, donor cells became permanently established as soon as 6 weeks after HSCT even in lead-shielded, nonirradiated marrow and lymph node sites. This result challenged the long-held concept that creation of marrow space by cytotoxic agents was needed for stable allogeneic engraftment and indicated that the grafts could create their own space, presumably helped by subclinical GVH reactions. It also raised the hope that future regimens might employ nontoxic T-cell immunosuppression rather than low-dose pretransplant irradiation. A first step in this direction was taken in a study in which blocking T-cell costimulation through CTLA4Ig fusion protein, and at the same time stimulating the T-cell receptor with HSC donor antigen, resulted in lowering of the pretransplant TBI dose needed for stable allogeneic engraftment from 200 to 100 cGy.<sup>16</sup>



**Figure 1.** Conceptual schema for outpatient transplants. CSP, cyclosporine; GVHD, graft-vs.-host disease; HSCT, hematopoietic stem cell transplantation; MMF, mycophenolate mofetil; TBI, total body irradiation.

Figure 1 shows a new conceptual schema for allogeneic HSCT in patients with nonmalignant and malignant hematologic diseases that was developed on the basis of the results of the preclinical canine studies.<sup>17,18</sup> The schema postulates that patients with T-cell deficiency diseases, such as common variable immunodeficiency disease, do not need pretransplant conditioning; the validity of this concept has already been verified in several transplanted patients.<sup>19</sup> A dog model of hereditary hemolytic anemia has allowed evaluation of the nonmyeloablative HSCT approach in the treatment of another nonmalignant genetic disease,<sup>20</sup> and findings in that model have now been successfully translated to human patients with sickle cell anemia (unpublished data).

In patients with malignant hematologic diseases, initial mixed chimerism was expected to spontaneously convert to all-donor chimerism either during an episode of acute GVHD or after an injection of donor lymphocytes. The concept has been successfully applied as therapy in patients with acute and chronic leukemias, myelodysplasia, Hodgkin's and non-Hodgkin's lymphoma, and multiple myeloma who were deemed ineligible for conventional transplants because of age or medical infirmity.<sup>21</sup> The regimen included pretransplant TBI 200 cGy administered as a single fraction at a rate of 7 cGy/minute, CSP 6.25 mg/kg bid po on days -3 to 35 with subsequent taper through day 56, and MMF 15 mg/kg bid po beginning in the afternoon of day 0 through day 27. Granulocyte colony-stimulating factor-mobilized unmodified peripheral blood stem cells from HLA-identical sibling donors were infused on day 0. Forty-four patients with a median age of

56 years (range, 31 to 72 years) were entered on protocol. Follow-up was at a median of 429 days (range, 320–769 days). Diagnoses were acute myeloid leukemia (AML) ( $n = 11$ ), chronic myeloid leukemia (CML) ( $n = 8$ ), chronic lymphocytic leukemia (CLL) ( $n = 8$ ), multiple myeloma (MM) ( $n = 6$ ), Hodgkin's disease ( $n = 4$ ), non-Hodgkin lymphoma (NHL) ( $n = 3$ ), Waldenström's disease ( $n = 2$ ), acute lymphoblastic leukemia (ALL) ( $n = 1$ ), and myelodysplastic syndrome (MDS) ( $n = 1$ ). Transplants were well tolerated, with mild myelosuppression, no mucositis, no new-onset alopecia, and reversible hyperbilirubinemia in 3 patients. Among the 32 patients who were eligible for outpatient allografting, the median number of hospitalization days (through day 60) was 0 (range, 0–26). Nonfatal graft rejection occurred in 9 patients (20%). Grade II acute GVHD was seen in 36% of engrafted patients, grade III in 11%, and grade IV in none. Three patients (6.8%) died of transplant complications between days 54 and 360, and 26.7% of patients died from relapse. Twenty-nine patients had pretransplant exposure to intensive chemotherapy, including failed autologous transplants, or had received multiple cycles of purine analogs, and 28 of them had sustained donor cell engraftment. Major disease responses were observed in 48% of patients who had measurable disease pretransplant and sustained donor engraftment. These included all 5 CML patients with complete molecular responses, 5 of 7 CLL patients, 1 of 3 AML patients, the 1 ALL patient, 4 of 6 MM patients, 2 of 4 Hodgkin's disease patients, 1 of 3 NHL patients, and 1 of 2 Waldenström's disease patients. Five patients with CML and 2 with CLL achieved complete molecular (polymerase chain reaction) remissions. Although the follow-up of 429 days is too short to assess definitive antitumor effects, this novel approach has dramatically reduced the acute toxicities of allografting even in elderly patients and has allowed for the induction of graft-vs.-tumor effects in an ambulatory care setting. Addition of 3 doses of fludarabine, 30 mg/m<sup>2</sup> per day for 3 days, to the immunosuppression has enhanced engraftment, even in the unrelated transplant setting; extending the postgrafting immunosuppression might reduce GVHD without significantly increased toxicity, thereby facilitating further studies of adoptive immunotherapy in various malignancies and also for cure of selected nonmalignant diseases.

### ACKNOWLEDGMENTS

Supported in part by grants HL36444, HL03701, CA18221, CA15704, CA78902, CA49605 and DK42716 from the National Institutes of Health, Bethesda, Maryland. Support was also provided by the Gabriella Rich Leukemia Foundation. R.S. also received support from the Laura Landro Salomon Endowment Fund and through a prize awarded by the Josef Steiner Krebsstiftung, Bern, Switzerland.

## REFERENCES

1. Jacobson LO, Marks EK, Robson MJ, Gaston EO, Zirkle RE. Effect of spleen protection on mortality following x-irradiation. *J Lab Clin Med* 34:1538–1543, 1949.
2. Nowell PC, Cole LJ, Habermeyer JG, Roan PL. Growth and continued function of rat marrow cells in x-radiated mice. *Cancer Res* 16:258–261, 1956.
3. Ford CE, Hamerton JL, Barnes DWH, Loutit JF. Cytological identification of radiation-chimaeras. *Nature* 177:452–454, 1956.
4. Main JM, Prehn RT. Successful skin homografts after the administration of high dosage X radiation and homologous bone marrow. *J Natl Cancer Inst* 15:1023–1029, 1955.
5. Thomas ED, Storb R, Clift RA, et al. Bone-marrow transplantation. *N Engl J Med* 292:895–902, 1975.
6. Burchenal JH, Oettgen HF, Holmberg EAD, Hemphill SC, Reppert JA. Effect of total body irradiation on the transplantability of mouse leukemias. *Cancer Res* 20:425, 1960.
7. Barnes DWH, Loutit JF. Treatment of murine leukaemia with x-rays and homologous bone marrow: II. *Br J Haematol* 3:241–252, 1957.
8. Mathe G, Amiel JL, Schwarzenberg L, Catton A, Schneider M. Adoptive immunotherapy of acute leukemia: experimental and clinical results. *Cancer Res* 25:1525–1531, 1965.
9. Weiden PL, Flournoy N, Thomas ED, et al. Antileukemic effect of graft-versus-host disease in human recipients of allogeneic-marrow grafts. *N Engl J Med* 300:1068–1073, 1979.
10. Weiden PL, Sullivan KM, Flournoy N, Storb R, Thomas ED, and the Seattle Marrow Transplant Team. Antileukemic effect of chronic graft-versus-host disease: contribution to improved survival after allogeneic marrow transplantation. *N Engl J Med* 304:1529–1533, 1981.
11. Kolb HJ, Mittermüller J, Clemm CH, et al. Donor leukocyte transfusions for treatment of recurrent chronic myelogenous leukemia in marrow transplant patients. *Blood* 76:2462–2465, 1990.
12. Kolb HJ, Schattenberg A, Goldman JM, et al. Graft-versus-leukemia effect of donor lymphocyte transfusions in marrow grafted patients: European Group for Blood and Marrow Transplantation Working Party Chronic Leukemia. *Blood* 86:2041–2050, 1995.
13. Yu C, Storb R, Mathey B, et al. DLA-identical bone marrow grafts after low-dose total body irradiation: effects of high-dose corticosteroids and cyclosporine on engraftment. *Blood* 86:4376–4381, 1995.
14. Storb R, Yu C, Wagner JL, et al. Stable mixed hematopoietic chimerism in DLA-identical littermate dogs given sublethal total body irradiation before and pharmacological immunosuppression after marrow transplantation. *Blood* 89:3048–3054, 1997.
15. Storb R, Yu C, Barnett T, et al. Stable mixed hematopoietic chimerism in dog leukocyte antigen-identical littermate dogs given lymph node irradiation before and pharmacologic immunosuppression after marrow transplantation. *Blood* 94:1131–1136, 1999.
16. Storb R, Yu C, Zaucha JM, et al. Stable mixed hematopoietic chimerism in dogs given donor antigen, CTLA4Ig, and 100 cGy total body irradiation before and pharmacologic immunosuppression after marrow transplant. *Blood* 94:2523–2529, 1999.
17. Storb R, Yu C, McSweeney P. Mixed chimerism after transplantation of allogeneic hematopoietic cells. In: Thomas ED, Blume KG, Forman SJ, eds. *Hematopoietic Cell Transplantation*, 2nd ed. Boston, MA: Blackwell Science, 1999, p. 287–295.

18. Storb R. Nonmyeloablative preparative regimens: experimental data and clinical practice. In: Perry MC, ed. *ASCO Education Book*. 1999, p. 241–249.
19. Woolfrey AE, Nash RA, Frangoul HA, et al. Non-myeloablative transplant regimen used for induction of multi-lineage allogeneic hematopoietic mixed donor-host chimerism in patients with T-cell immunodeficiency [abstract]. *Blood* 92 (Suppl 1):520a, 1998.
20. Yu C, Nash R, Lothrop C, Zaucha J, Storb R. Severe canine hereditary hemolytic anemia treated by marrow grafts using nonmyeloablative immunosuppression [abstract]. *Blood* 92 (Suppl 1):263a, 1998. Abstract 1078.
21. McSweeney PA, Wagner JL, Maloney DG, et al. Outpatient PBSC allografts using immunosuppression with low-dose TBI before, and cyclosporine (CSP) and mycophenolate mofetil (MMF) after transplant [abstract]. *Blood* 92 (Suppl 1):519a, 1998. Abstract 2133.

# **Mixed Lymphohematopoietic Chimerism and Delayed Donor Leukocyte Infusions Following Nonmyeloablative Conditioning and HLA-Matched and -Mismatched Donor Bone Marrow Transplantation**

**Thomas R. Spitzer, Steven McAfee, Robert Sackstein,  
Christine Colby, Bimal Dey, Susan Saidman, Frederic Preffer,  
Steve Alexander, David H. Sachs, Megan Sykes**

*Bone Marrow Transplantation Program/Department of Medicine (T.R.S., S.M.,  
R.S., C.C., B.D.), Department of Pathology (S.S., F.P.), Transplantation Biology  
Research Center/Department of Surgery (S.A., D.H.S., M.S.), Massachusetts  
General Hospital and Harvard Medical School, Boston, Massachusetts*

## **ABSTRACT**

Mixed lymphohematopoietic chimerism (MLC) has been reliably induced in preclinical models and in preliminary clinical trials using nonmyeloablative preparative therapy and allogeneic bone marrow or peripheral blood stem cell transplantation. Based on a murine model in which MLC was induced and then converted to full donor hematopoiesis without graft-vs.-host disease (GVHD) using delayed donor leukocyte infusions (DLIs), we developed a treatment regimen for hematologic malignancies. The regimen involved cyclophosphamide (CY), in vivo T-cell depletion (TCD) using anti-T-cell antibodies, cyclosporine, and HLA-matched or -mismatched bone marrow transplantation (BMT). DLIs were administered beginning 5 weeks posttransplant to patients who had MLC and no evidence of GVHD. Thirty-six patients received an HLA-matched BMT for advanced hematologic malignancies including non-Hodgkin's lymphoma (NHL) ( $n = 20$ ), Hodgkin's disease ( $n = 6$ ), acute myeloid leukemia (AML) ( $n = 5$ ), acute lymphoblastic leukemia ( $n = 1$ ), multiple myeloma ( $n = 1$ ), and chronic lymphocytic leukemia (CLL) ( $n = 3$ ). Preparative therapy for matched BMT consisted of CY 150–200 mg/kg days  $-5$  to  $-3$  or  $-2$ , antithymocyte globulin (ATG) 15–30 mg/kg days  $-2$ ,  $-1$ , and 1 or  $-1$ , 1, 3, and 5 and thymic irradiation 700 cGy day  $-1$ . Nine of 34 (26%) evaluable patients developed grade  $\geq$ II GVHD (6 grade II; 3 grade III–IV). MLC was demonstrated in all 34 evaluable patients. Eleven patients (29%) ultimately lost their grafts 28 to 144 days post-BMT. Six

of the 12 evaluable recipients of prophylactic DLIs converted to full donor hematopoiesis. Sixteen (47%) of 34 evaluable patients achieved a response (11 complete response [CR]; 5 partial response). Disease-free survival (DFS) and overall survival rates at 24 months were 25% and 38%, respectively. Twenty-one patients received a BMT mismatched for the HLA-1 to -3 antigen (in the GVHD direction). Fourteen recipients of an HLA-1 to -2 antigen-mismatched BMT received ATG (15 to 30 mg/kg days -2, -1, and 1 or, -1, 1, 3, and 5); 7 patients received anti-CD2 monoclonal antibody therapy (MEDI-507; Biotransplant, Charlestown, MA) for in vivo TCD. Of the 14 ATG recipients (11 NHL, 1 AML, 1 CLL, 1 multiple myeloma), 11 were evaluable for chimerism. Seven patients achieved sustained MLC, and 4 converted spontaneously to full donor chimerism. Twelve developed grade  $\geq$ II GVHD (6 grade II, 6 grade III-IV). Four patients are alive, and 2 are in a durable CR at 15 and 36 months post-BMT. MEDI-507 was given to 7 recipients. Transient mixed chimerism followed by graft loss was seen in the first 4 patients; in the subsequent 3 patients, who received an altered MEDI-507 regimen, grade  $>$ II GVHD occurred in 2 patients who achieved full donor chimerism without DLIs, and 1 patient had a low percentage of donor cells by day 28. Five of the 7 MEDI-507 recipients are alive,  $<$ 2 to 9 months post-BMT. This novel nonmyeloablative transplant regimen is associated with the reliable induction of MLC following HLA-matched and mismatched BMT. Durable remissions with minimal GVHD and conversion to full donor hematopoiesis have been achieved in some patients with refractory hematologic malignancies following DLI. MEDI-507 may be more effective than ATG in preventing GVHD following HLA-mismatched donor BMT.

## INTRODUCTION

A fundamental question in bone marrow transplantation is how to maximize graft-vs.-tumor effects in the early posttransplant period (when tumor load has been minimized by the chemoradiotherapy of the conditioning regimen and residual tumor eradication is left to the immune system), while minimizing the deleterious effects of GVHD. Long-term DFS of patients with advanced hematologic malignancies depends greatly on the generation of allogeneic immune responses against the tumor, with the kinetics of graft-vs.-tumor reactivity and of tumor regrowth ultimately deciding the remission status following the transplant. Thus, the development of transplant regimens that are associated with a reduced risk of GVHD and a rapid generation of antitumor immune capabilities is a major goal of transplantation biology.

Although allogeneic BMT is potentially a curative therapy for a variety of hematologic malignancies, successful application has been limited by several complications, including rejection, GVHD, and prolonged immunoincompetence.<sup>1-11</sup>



These complications are more common (and more severe) following HLA-mismatched donor allogeneic BMT.<sup>12–18</sup> However, the major potential advantage of successful transplantation across HLA barriers is an improved antitumor effect attributable to an enhanced graft-vs.-host alloresponse that also eliminates malignant cells.<sup>19–22</sup> Experience from Seattle and the International Bone Marrow Transplant Registry has shown that BMT using HLA-genotypically or -phenotypically identical or single-antigen-mismatched related donors is associated with statistically similar survival probabilities,<sup>16,17</sup> probably because the increased risks of graft rejection and GVHD associated with non-HLA-identical donor transplants are offset by a reduced probability of relapse (secondary to an increased GVL effect). With the use of HLA 2- or 3-antigen-disparate family donors, increased antitumor effects may not be realized due to an increase in transplant-related mortality.<sup>16</sup> Novel approaches are clearly needed to expand the availability of BMT to allow transplants from HLA-mismatched donors, improve the safety profile, and enhance the graft-vs.-malignancy effects associated with allogeneic transplantation.

Recently, attempts have been made to minimize transplant-related mortality with less intensive, nonmyeloablative conditioning regimens while maximizing the antitumor properties with adoptive cellular immunotherapy via donor leukocyte infusions.<sup>23–25</sup> Whereas several investigators report intriguing results using nonmyeloablative transplant strategies, transplantation across HLA barriers, the optimization of innovative nonablative conditioning therapies, and the definition of the optimal dosing and timing of DLI represent major challenges to the cure of advanced, treatment-refractory hematologic malignancies.

In several animal models, mixed lymphohematopoietic chimerism has been achieved following nonmyeloablative conditioning therapy<sup>26–29</sup> and transplantation across full MHC barriers.<sup>26</sup> Mixed chimerism is achievable in mice following nonmyeloablative conditioning therapy that includes T-cell-depleting monoclonal antibodies (mAbs) with either low-dose whole body irradiation (3 Gy) or cyclophosphamide (200 mg/kg) followed by thymic irradiation.<sup>29,30</sup> In this murine model, a T-cell-depleting mAb is used in the preparative regimen to deplete the host T cells, and because it persists for several weeks posttransplant, it also depletes donor T cells, thus avoiding GVHD. These mixed chimeras are resistant to GVHD when delayed DLIs are given, even though the DLIs mediate lymphohematopoietic GVH reactions that convert their mixed chimerism to full allogeneic chimerism.<sup>30</sup> The nonmyeloablative preparative regimen combined with the deliberate induction of a mixed chimeric state—with time allowed for recovery from conditioning-induced injury—may be protective against acute GVHD by allowing donor alloreactivity to occur in the presence of nonspecific host tissue injury, and possibly by allowing the recovery of host cell populations that resist GVHD. In addition, the use of a nonmyeloablative preparative regimen circumvents the problem of permanent aplasia in the event of allograft rejection.

Based on our murine model, we initiated a clinical trial to define the optimal strategy for the intentional induction of mixed lymphohematopoietic chimerism following a nonmyeloablative conditioning regimen and HLA-matched or -mismatched related allogeneic bone marrow transplantation for patients with hematologic malignancies.<sup>21,31</sup> This approach offers several potential advantages over conventional allogeneic BMT. Cyclophosphamide at a dose of 150 mg/kg is not myeloablative, as is evidenced by the robust host marrow reconstitution observed in our patients who have rejected their donor graft, and is associated with less regimen-related morbidity and mortality than most conventional transplant preparative regimens. Whereas the decreased aggressiveness of chemotherapy could also mean less tumor cell elimination, the diminished cytoreductive effects of chemotherapy could be outweighed by an enhanced graft-vs.-malignancy effect, particularly if DLIs can be given without causing GVHD and/or if HLA barriers can be overcome.

The ultimate goal of our T-cell-depleting regimen is to deplete both donor and recipient T cells so that donor marrow engraftment can be achieved and the GVHD that would otherwise be induced by donor T cells in the marrow inoculum will be avoided. Since this has been achieved in most HLA-matched transplants, we have been able to administer DLIs at day 35 to patients with mixed chimerism who had no evidence of GVHD to capture the graft-vs.-tumor effects of this potent GVH reaction. However, the high probability of acute GVHD in the first 13 recipients of HLA-mismatched BMT conditioned with ATG indicated that ATG was insufficient to reliably eliminate GVH-reactive donor T cells in the donor marrow. MEDI-507, a humanized anti-CD2 monoclonal antibody, was therefore substituted for ATG in recipients of HLA 2- or 3-antigen-mismatched BMT. MEDI-507 has been shown to result in marked T-cell depletion of peripheral blood and lymph nodes in animal models and has been well tolerated in early studies.

## **PATIENTS AND METHODS**

### **Patient Characteristics**

Sixty patients with advanced hematologic malignancies were enrolled; 57 patients with a median age of 43 years (range, 16–62 years) were transplanted (Table 1). This included 35 patients with NHL, 8 with Hodgkin's lymphoma, 2 with multiple myeloma, 4 with CLL, and 8 with acute leukemia (1 lymphoblastic and 7 myelogenous). Thirty-six were recipients of a HLA-matched BMT, and 21 recipients received an HLA-mismatched BMT (4 one antigen, 15 two antigens, and 2 three antigens in the GVH direction; only mismatches of HLA-A, -B, or -DR alleles were considered). Eleven patients had disease recurrence shortly after an autologous stem cell transplant, and 2 patients had disease progression during or shortly after radiation therapy.

**Table 1.** Patient Characteristics

Number of patients enrolled	60
Number of patients transplanted	57
Median age, y (range)	43 (16–62)
Sex, M/F	34/23
Diagnosis	
Non-Hodgkin's lymphoma	35
Hodgkin's disease	8
Acute myelogenous leukemia	7
Acute lymphoblastic leukemia	1
Chronic lymphocytic leukemia	4
Multiple myeloma	2
Donor/recipient HLA status	
HLA matched	36
HLA mismatch	21
1 antigen	4
2 antigens	15
3 antigens	2
Previous autologous stem cell transplant	11

### Treatment Schema

The preparative therapy consisted of CY 150–200 mg/kg, ATG 15–30 mg/kg per day on days –2, –1, and 1 or –1, 1, 3, and 5, and thymic irradiation 700 cGy as a 1-time dose on day –1 in patients who had not previously received mediastinal radiation therapy. The first 14 HLA-mismatched BMT recipients received ATG. The subsequent 7 HLA 2- and 3-antigen-mismatched recipients were treated with MEDI-507 as the T-cell-depleting antibody. The first 4 recipients of MEDI-507 were treated with a test dose (0.1 mg/kg) on day –2 followed by 3 treatment doses (0.6 mg/kg) on days –1, 0, and 1. Due to the loss of donor hematopoiesis and higher than expected MEDI-507 serum levels beyond day 35 posttransplant, the next 3 patients were treated with a test dose on day –7 and 2 treatment doses given on days –6 and –5.

Intravenous cyclosporin A (CsA) was begun on day –1 for GVHD prophylaxis. CsA was tapered and discontinued as soon as day 35 in patients who did not have GVHD or suspicion of GVHD. Following a successful CsA taper, a prophylactic DLI ( $1 \times 10^7$ /kg CD3<sup>+</sup> cells) was given beginning on day 35 to patients who had mixed chimerism and no evidence of GVHD in an effort to maximize the GVL effect and convert the mixed chimerism to a state of full donor hematopoiesis. DLIs were initially administered on days 35 and 56 posttransplant. Due to the development of severe GVHD in 2 patients following the day 56 DLI, the second prophylactic DLI was omitted from the treatment protocol.

## RESULTS

### Transplant-Related Toxicity

Significant transplant-related morbidity included cyclophosphamide-induced cardiac toxicity in 4 patients and ATG infusion-related toxicities in 3 patients, necessitating dose reductions in subsequent patients. Of 60 patients enrolled on this protocol, 3 had disease progression before receiving a transplant. One patient died on day 12 secondary to pulmonary hemorrhage, 1 patient died due to unexplained central nervous system toxicity on day 63, and 1 patient died on day 77 due to posttransplant lymphoproliferative disease. Late posttransplant deaths (days 108, 180, 405, and 559) have occurred due to opportunistic infections in 3 patients and a myocardial infarction in 1 patient who had a history of coronary artery disease before transplant. All 4 patients were in complete clinical remission at the time of their death.

An engraftment syndrome, consisting in most cases of fever, fluid retention, and rash, was seen in 41 patients (72%). Although a clear distinction of GVHD from the engraftment syndrome was not always possible, skin biopsies were usually not diagnostic of GVHD and the clinical manifestations often resolved quickly following the administration of corticosteroids, which were rapidly tapered and discontinued in many cases. Results of chimerism analyses and mixed lymphocyte reaction assays, moreover, suggested that, in some instances, a host-vs.-graft reaction may have been at least partially responsible for the clinical manifestations of the engraftment syndrome .

### Graft-vs.-Host Disease

Grade  $\geq$ II acute GVHD occurred in a total of 23 of 56 evaluable patients (40%) initially posttransplant, including 9 of 34 (26%) HLA-matched BMT recipients (6 grade II, 3 grade III–IV) and 14 of 21 (66%) HLA-mismatched BMT recipients (7 grade III–IV). Of these 14 HLA-mismatched recipients, 11 had received ATG and 2 had received MEDI-507. Five of 12 evaluable HLA-matched recipients developed grade  $>$ II GvHD following DLI given for chimerism conversion. Two of the recipients of 2 prophylactic DLIs developed severe (grade III–IV) GVHD, prompting the omission of the day 56 DLI in subsequent patients. Only 3 of the 7 evaluable recipients of a single prophylactic DLI have developed grade  $>$ II GVHD. Of HLA-matched recipients who developed early grade  $>$ II GVHD (thus precluding a prophylactic DLI), 6 developed grade II GVHD limited to the skin. Chronic GVHD has developed in 6 (43%) of the 15 evaluable HLA-matched recipients. Limited chronic GVHD (requiring minimal immunosuppression) has developed in 3 HLA-mismatched transplant recipients who have been followed for more than 18 months.

## Chimerism Analysis

Chimerism was assessed by flow cytometry analysis, or if HLA allele-specific mAbs could not distinguish donor and host, by variable number of tandem repeats (VNTR) analysis of weekly blood samples beginning 7–12 days post-BMT (through day 100, then every 6 months) and bone marrow aspirates (days 28 and 100 and 6 months posttransplant). Fifty-three of 55 evaluable patients achieved at least initial lymphohematopoietic mixed chimerism following transplantation, defined by the presence of >1% donor cells, including all 34 evaluable recipients of an HLA-matched BMT and 18 of 20 evaluable recipients of an HLA-mismatched BMT.

Thirteen patients who received an HLA-matched BMT converted to full donor chimerism, defined as >99% donor by VNTR analysis (without DLI administration in 3), and 11 recipients lost evidence of (reverted to <1%) donor chimerism at a median of 45 days (range, 28–144 days) posttransplant. Eighteen of the 20 evaluable HLA-mismatched marrow recipients achieved initial mixed chimerism. The initial 4 MEDI-507 recipients lost evidence of their donor grafts early posttransplant (between days 14 and 75 posttransplant). Of the 3 recipients who received the second MEDI-507 dosing regimen, 2 achieved full donor chimerism by day 21 and day 42 without DLI, and the third recipient had very a small population (1%) of donor cells at day 28 posttransplant. Of the 13 evaluable recipients of ATG, 11 achieved mixed chimerism, 4 converted to full donor chimerism, and 7 had mixed chimerism at the time of last follow-up. All patients showed varying percentages of donor chimerism (split-lineage chimerism) among lymphocytes, monocytes, and neutrophils.

## Effects of DLI

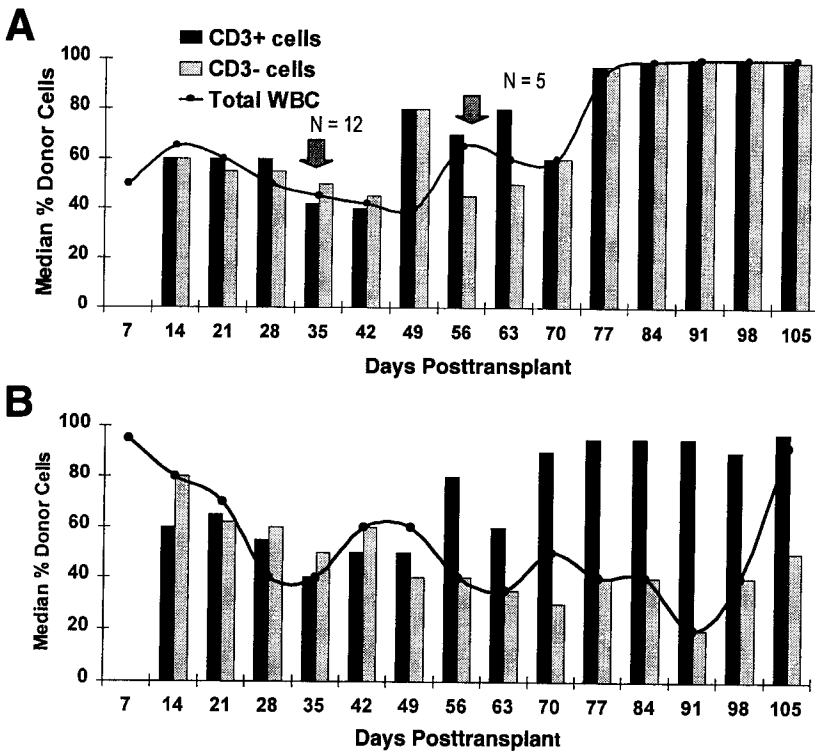
Donor leukocyte infusions have been administered to 23 HLA-matched donor BMT recipients, 13 for the conversion of mixed chimerism to full donor hematopoiesis (prophylactic DLI) and 13 for the treatment of posttransplant relapse (in 3 patients following a prophylactic DLI). Six of the 11 evaluable recipients of prophylactic DLI converted to full donor hematopoiesis in both the T-cell and the non-T-cell subsets (Figure 1A). Seven of these 11 patients developed grade >II acute and/or chronic GVHD. Among the 7 evaluable recipients of a single DLI, 4 developed acute and/or chronic GVHD. Of the 13 patients who received DLI for the treatment of progressive malignancy, *de novo* or progressive GVHD occurred in 6.

Because of acute GVHD or absence of mixed chimerism, none of the HLA-mismatched recipients who received ATG were given DLIs. The first 4 recipients of MEDI-507 antibody therapy were given DLIs during a progressive loss of donor hematopoiesis (day 35 to 76 posttransplant). All 4 patients subsequently lost

evidence of their donor graft. Of the second cohort of MEDI-507 recipients, 1 received a DLI at day 44 during a decline in the percentage of donor cells.

### Response

Twenty (42%) of 48 evaluable patients achieved a clinical response. Fourteen recipients (11 HLA-matched and 3 HLA-mismatched) achieved a clinical complete remission, and 6 recipients (5 HLA-matched and 1 HLA-mismatched) achieved a partial remission. Twenty-three (39%) patients are alive, 13 (23%) of whom are progression free at a median of 261 days (range, 25–1139 days) posttransplant.



**Figure 1.** The pattern of chimerism as demonstrated by the median percentage of donor cells found in the peripheral white blood cell count (WBC) over time in 12 recipients of an HLA-matched donor bone marrow transplantation who received a prophylactic donor leukocyte infusion (DLI) beginning on day 35 and in 4 who received a second DLI beginning on day 56 posttransplant (arrows indicate time of DLI administration) (A) and in 7 patients who did not receive DLI posttransplant due to the presence or suspicion of GVHD (B). Chimerism was determined by microsatellite analysis and is shown as estimates of the percentage of donor DNA present in the total WBC and in the CD3<sup>+</sup> and CD3<sup>-</sup> subsets.

Seven (12%) patients died of transplant-related complications, and 27 (47%) died as a result of recurrent or progressive malignancy.

## DISCUSSION

Striking antitumor responses have been seen in a significant percentage of patients with chemoradiotherapy-refractory hematologic malignancies following this novel nonmyeloablative preparative regimen. Mixed lymphohematopoietic chimerism has been seen at least initially in all evaluable cases, including after HLA-mismatched transplants. Mixed chimerism following conditioning with a nonmyeloablative regimen has also for the first time been demonstrated following HLA-mismatched BMT. The conversion to full chimerism with mild or absent GVHD in association with marked leukemia/lymphoma responses in several patients thus far demonstrates the principle that GVH reactions can be largely confined to the lymphohematopoietic system if, after a delay, DLIs are given to patients with mixed chimerism without GVHD.

The deliberate induction of mixed hematopoietic chimerism using this nonmyeloablative conditioning approach that includes *in vivo* posttransplant T-cell depletion with either ATG or MEDI-507 represents an innovative strategy for separating GVL effects from GVHD, even across HLA barriers. The achievement of durable complete remissions, predominantly in patients who received prophylactic DLIs, demonstrates that mixed chimerism is an important platform for the potent immunotherapeutic effects of DLI.

In contrast to the murine model, GVHD was not prevented by an ATG-containing conditioning regimen. Significant GVHD was seen in most recipients of an HLA-mismatched transplant, precluding use of DLI. GVHD was also seen in approximately half of the HLA-matched transplant recipients of a single prophylactic DLI. Central to the success of the murine model has been an effective *in vivo* depletion of host and donor T cells. With the use of the MEDI-507, a profound T-cell depletion has been achieved, and in the first 4 recipients of a 2- or 3-antigen mismatched transplant, GVHD was prevented. Because of the lack of sustained engraftment and higher than anticipated serum MEDI-507 levels beyond day 35 posttransplant, a change in the dose and schedule of MEDI-507 was instituted. More stable engraftment, albeit with GVHD in 2 of 3 recipients of an HLA-mismatched transplant, has been achieved, demonstrating that complete deletion of donor T cells was not achieved with this regimen and additional anti-T-cell therapy and higher stem cell doses may be needed to overcome the delicate balance between GVHD and HVG alloreactivity so that DLIs may ultimately be given to this group of patients.

The achievement of mixed chimerism using this nonmyeloablative transplant strategy without GVHD has important implications for the treatment of malignant

and nonmalignant disease, as well as for the inducement of donor-specific allo-tolerance. Future efforts will focus on the optimal delivery of the components of this regimen and on the study of posttransplant immunological responses.

## REFERENCES

1. Champlin RE, Horowitz MM, Van Bekkum DW. Graft failure following bone marrow transplantation for severe aplastic anemia: risk factors and treatment results. *Blood* 73:606–613, 1989.
2. Cheng L, Dejbakhsh-Jones S, Liblau R, Zeng D, Strober S. Different patterns of TCR transgene expression in single-positive and double-negative T cells. *J Immunol* 156: 3591–3601, 1996.
3. Colby C, Sykes M, Sachs DH, Spitzer TR. Cellular modulation of acute graft-vs.-host disease. *Biol Blood Marrow Transplant* 3:287–293, 1998.
4. Dazzi F, D'Andrea E, Biasi G, et al. Failure of B cells of chronic lymphocytic leukemia in presenting soluble and alloantigens. *Clin Immunol Immunopathol* 75:26–32, 1995.
5. Deacock S, Schwarzer A, Batchelor R, Goldman J, Lechler R. A rapid limiting dilution assay for measuring frequencies of alloreactive, interleukin-2-producing T cells in human. *J Immunol Methods* 147:83–92, 1992.
6. Donovan JW, Andersen NS, Poor C, Bowers D, Gribben JG. Prospective analysis of minimal residual disease detection in patients with CLL undergoing autologous and allogeneic BMT [abstract]. *Blood* 92:652a, 1998.
7. Donovan JW, Ladetto M, Gribben JG. A novel method for assessing the dynamics of residual disease in B-cell malignancies by real-time quantitative PCR [abstract]. *Blood* 92 (Suppl 1):225a, 1998.
8. Dumont-Girard F, Roux E, van Lier RA, et al. Reconstitution of the T-cell compartment after bone marrow transplantation: restoration of the repertoire by thymic emigrants. *Blood* 92:4464–4461, 1998.
9. Falo LD Jr, Colarusso LJ, Benacerraf B, Rock KL. Serum proteases alter the antigenicity of peptides presented by class I major histocompatibility complex molecules. *Proc Natl Acad Sci U S A* 89:8347–8350, 1992.
10. Fearnley DB, McLellan AD, Mannering SI, Hock BD, Hart DNJ. Isolation of human blood dendritic cells using the CMRF-44 monoclonal antibody: implications for studies on antigen-presenting cell function and immunotherapy. *Blood* 89:3708–3712, 1997.
11. Ferrara JLM, Deeg HJ. Graft-versus-host disease. *N Engl J Med* 324:667–674, 1991.
12. Anasetti C, Amos D, Beatty PG, et al. Effect of HLA compatibility on engraftment of bone marrow transplants in patients with leukemia or lymphoma. *N Engl J Med* 320: 197–204, 1989.
13. Ash RC, Casper JT, Chitambar CR, et al. Successful allogeneic transplantation of T-cell-depleted bone marrow from closely HLA-matched unrelated donors. *N Engl J Med* 322: 485–492, 1990.
14. Aversa F, Tabilio A, Terenzi A, et al. Successful engraftment of T-cell-depleted haploidentical “three-loci” incompatible transplants in leukemia patients by addition of recombinant human granulocyte colony-stimulating factor-mobilized peripheral blood



- progenitor cells to bone marrow inoculum. *Blood* 84:3948–3955, 1994.
15. Aversa F, Tabilio A, Velardi A, et al. Treatment of high-risk acute leukemia with T cell-depleted stem cells from related donors with one fully mismatched haplotype. *N Engl J Med* 339:1186–1193, 1998.
  16. Beatty PG, Clift RA, Mickelson FM, et al. Marrow transplantation from related donors other than HLA-identical siblings. *N Engl J Med* 313:765–771, 1985.
  17. Bortin MM. Bone marrow transplantation for leukemia using family donors other than HLA-identical siblings: a preliminary report from the International Bone Marrow Transplant Registry. *Transplant Proc* 19:2629–2631, 1987.
  18. Henslee-Downey PJ, Abhyankar SH, Parrish RS, et al. Use of partially mismatched related donors extends access to allogeneic marrow transplant. *Blood* 89:3864–3872, 1997.
  19. Porter DL, Roth MS, McGarigle C, Ferrara JL, Antin JH. Induction of graft-versus-host disease as immunotherapy for relapsed chronic myeloid leukemia. *N Engl J Med* 330:100–106, 1994.
  20. Ratanatharathorn V, Uberti J, Karanes C, et al. Prospective comparative trial of autologous versus allogeneic bone marrow transplantation in patients with non-Hodgkin's lymphoma. *Blood* 84:1055–1055, 1994.
  21. Sykes M, Preffer F, McAfee S, et al. Mixed lymphohematopoietic chimerism and graft-vs-lymphoma effects are achievable in adult humans following non-myeloablative therapy and HLA-mismatched donor bone marrow transplantation. *Lancet* 353:1755–1779, 1999.
  22. Verdonck LF, Deller AW, Lokhorst HM, Petersen EJ, Nieuwenhuis HK. Allogeneic versus autologous bone marrow transplantation for refractory and recurrent low-grade non-Hodgkin's lymphoma. *Blood* 90:4201–4205, 1997.
  23. Giralt S, Estey E, Albitar M, et al. Engraftment of allogeneic hematopoietic progenitor cells with purine analog-containing chemotherapy: harnessing graft-versus-leukemia without myeloablative therapy. *Blood* 89:4531–4536, 1997.
  24. Giralt S, Gajewski J, Khouri I, et al. Induction of graft-vs-leukemia (GVL) as primary treatment of chronic myelogenous leukemia [abstract]. *Blood* 90 (Suppl 1):418a, 1997.
  25. Slavin S, Nagler A, Naparstek E, et al. Nonmyeloablative stem cell transplantation and cell therapy as an alternative to conventional bone marrow transplantation with lethal cytoreduction for the treatment of malignant and nonmalignant hematologic diseases. *Blood* 91:756–763, 1998.
  26. Ildstad ST, Wren SM, Bluestone JA, et al. Effect of selective T cell depletion of host and/or donor bone marrow on lymphopoietic repopulation, tolerance, and graft-vs.-host disease in mixed allogeneic chimeras (B10 + B10.D2→B10). *J Immunol* 136:28–33, 1984.
  27. Kawai T, Cosimi AB, Colvin RB, et al. Mixed allogeneic chimerism and renal allograft tolerance in cynomolgus monkeys. *Transplantation* 59:256–252, 1995.
  28. Sharabi Y, Sachs DH. Mixed chimerism and permanent specific transplantation tolerance induced by a non-lethal preparative regimen. *J Exp Med* 169:493–502, 1989.
  29. Storb R, Yi C, Wagner JL, et al. Stable mixed hematopoietic chimerism in DLA-identical littermate dogs given sublethal total body irradiation before and pharmacological immunosuppression after marrow transplantation. *Blood* 89:3048–3054, 1997.
  30. Pelot MR, Pearson DA, Swenson K, et al. Lymphohematopoietic graft-vs.-host reactions

can be induced without graft-vs.-host disease in murine mixed chimeras established with a cyclophosphamide-based non-myeloablative conditioning regimen. *Biol Blood Marrow Transplant* 5:133–143, 1999.

31. Spitzer TR, McAfee S, Sackstein R, et al. The intentional induction of mixed chimerism and achievement of anti-tumor responses following non-myeloablative conditioning therapy and HLA-matched donor bone marrow transplantation for refractory hematologic malignancies. *Biol Blood Marrow Transplant* 6:309–320, 2000.

# **Minor Histocompatibility Antigens in Graft-vs.-Host Disease and Graft-vs.-Leukemia Reactions**

***Stanley R. Riddell, Marc Gavin, Yoshiki Akatsuka,  
Makoto Murata, Philip D. Greenberg, Edus H. Warren***

*Program in Immunology, Fred Hutchinson Cancer Research Center,  
Seattle, Washington*

## **INTRODUCTION**

Donor T cells specific for recipient minor histocompatibility antigens (mHAg)s mediate both graft-vs.-host disease (GVHD) and a graft-vs.-leukemia (GVL) response following allogeneic hematopoietic stem cell transplantation (HCT) from an HLA-identical donor. Thus, the rate of leukemic relapse is higher in recipients of syngeneic HCT or T-cell-depleted allogeneic HCT compared with recipients of unmodified HCT.<sup>1</sup> New approaches to allogeneic HCT reduce the intensity of the conditioning regimen and rely largely on a GVL effect to eradicate the malignancy.<sup>2,3</sup> These nonmyeloablative transplants have less early treatment-related toxicity but are often complicated by GVHD. Several strategies that could be applied after myeloablative or nonmyeloablative HCT to potentially separate the beneficial GVL effect from GVHD are being investigated. The approach being pursued by our group is based on the finding that mHAg)s may exhibit restricted or preferential expression on recipient hematopoietic cells, including leukemic cells. Thus, augmenting T-cell responses to tissue-restricted mHAg)s by adoptive transfer to T-cell clones might selectively induce a GVL effect without GVHD.

## **mHAg)s DEFINED BY T-CELL CLONES**

Recent studies have demonstrated that mHAg)s recognized by CD8<sup>+</sup> T cells consist of peptides that are derived from polymorphic genes and presented by major histocompatibility complex (MHC) class I molecules on recipient cells. In an ongoing study at the Fred Hutchinson Cancer Research Center involving HLA-identical allogeneic bone marrow transplant (BMT) donor recipient pairs, CD8<sup>+</sup> cytotoxic T lymphocytes (CTLs) specific for mHAg)s are being isolated by stimulating peripheral blood mononuclear cells (PBMCs) obtained from the recipient after HCT with aliquots of  $\gamma$ -irradiated PBMCs obtained from the

recipient pretransplant and cryopreserved. mHAg-specific T-cell clones are generated from these polyclonal cultures by limiting dilution cloning techniques. A large number of CTL clones that recognize individual mHAgs encoded by autosomal genes have been isolated, including 10 mHAgs presented by HLA-A2 or -B7. These mHAgs appear to be distinct from the previously described HA-1, -2, -4, -5, -6, and -7 mHAgs on the basis of the tissue expression and/or population frequency of the minor H allele.<sup>4,5</sup> mHAgs presented by other class I HLA molecules including HLA-A3, -A11, -A29, -B37, -B41, -B44, -B53, and -Cw7 (Warren EH, Riddell SR, unpublished data).<sup>4</sup> All of the mHAg-specific CTLs we have generated recognize recipient hematopoietic cells, a finding that was expected because the cultures were initiated using hematopoietic cells for *in vitro* stimulation. However, approximately one half of the T-cell clones failed to lyse skin fibroblasts *in vitro*, suggesting that the genes encoding these mHAgs were not ubiquitously expressed in nonhematopoietic tissues.<sup>4</sup>

Other groups have also isolated T-cell clones reactive with mHAgs that are selectively expressed in hematopoietic cells. Goulmy<sup>5</sup> has characterized CD8<sup>+</sup> CTL clones that define 7 mHAgs designated HA-1 to HA-7 and encoded by autosomal genes.<sup>7,8</sup> HA-3, -4, -5, -6, and -7 are expressed by hematopoietic cells, endothelial cells, epithelial cells, and fibroblasts, suggesting broad, if not ubiquitous, expression of these mHAgs. However, HA-1 and HA-2 are not expressed in nonhematopoietic cells such as keratinocytes, fibroblasts, and renal epithelial cells, and these mHAgs were suggested as potential targets to induce a selective GVL response.<sup>6</sup> Dolstra et al.<sup>9</sup> isolated a CD8<sup>+</sup> CTL clone specific for a mHAg denoted HB-1, which is presented by HLA-B44 and is distinct from the B44 restricted mHAg defined by the CTL clones studied by our group (Dolstra H, Warren EH, unpublished data). Epstein-Barr virus (EBV)-transformed B cells and B-cell acute lymphocytic leukemia (B-ALL) cells were lysed *in vitro* by HB-1-specific CTLs, but skin fibroblasts, T cells, and monocytes were not recognized, suggesting that HB-1 expression is limited to a subset of hematopoietic cells. The gene encoding HB-1 has recently been identified, and its selective expression in transformed B cells and B-ALL cells but not normal hematopoietic cells was confirmed by molecular analysis.<sup>10</sup>

mHAgs encoded by the Y chromosome have also been described. Three H-Y antigens that are presented by HLA-A1, -A2, and -B7 and expressed by both hematopoietic and nonhematopoietic lineage cells have been described.<sup>5</sup> CD8<sup>+</sup> T-cell clones specific for a fourth H-Y antigen presented by HLA-B8 have recently been isolated by our group after transplantation of marrow from a female donor into a male recipient.<sup>11</sup> However, in contrast to previously described H-Y antigens, the B8-restricted CTLs lysed hematopoietic cells including leukemic blasts but not skin fibroblasts.

## IDENTIFICATION OF GENES ENCODING mHAgs

The isolation of T-cell clones with defined reactivity for individual mHAgs provided reagents to pursue the identification of the genes encoding mHAgs. Three primary strategies have been employed to identify the genes encoding mHAgs: (1) positional cloning to define the chromosome location of the gene<sup>12</sup>; (2) the elution of peptides from cell surface MHC molecules, separation of the fraction containing the mHAg peptide using biochemical techniques, and derivation of the sequence of the peptide using mass spectrometry<sup>13</sup>; and (3) screening of cDNA expression libraries constructed from mHAg-positive cells using mHAg-reactive T cells.<sup>10,14</sup>

The peptide elution method has been used to identify the amino acid sequence of 5 human mHAgs: the HA-1 and HA-2 antigens,<sup>15,16</sup> a newly identified HLA-A2-restricted mHAg termed HA-8 identified by our group (Brinckner AG, Warren EH, Caldwell JA, et al., unpublished data), and 3 H-Y antigens.<sup>17-19</sup> The peptide corresponding to HA-1 is encoded in a gene designated KIAA0223, which was derived from an acute myeloid leukemia (AML) cell line and is present in at least 2 alleles that differ at only a single amino acid in the nonamer epitope recognized by HA-1-specific CTLs.<sup>16</sup> As predicted from in vitro cytotoxicity assays, the expression of KIAA0223 mRNA is restricted to hematopoietic cells, suggesting it may be a suitable target to induce a GVL response.<sup>20</sup> The amino acid sequence of HA-2 closely matches but is not identical to that of a class I myosin gene.<sup>15</sup> The failure to conclusively assign a gene to HA-2 has precluded definitive studies of tissue expression. The peptide corresponding to HA-8 is encoded by a gene designated KIAA0020 (Brinckner AG, Warren EH, Caldwell JA, et al., unpublished data). Remarkably, the critical polymorphism responsible for the HA-8 epitope results in an alternation in peptide processing or transport rather than affecting binding of the peptide to HLA-A2 or the peptide/MHC complex to the T-cell receptor. The T-cell clone SKH-13 is specific for HA-8 lysis in both hematopoietic and nonhematopoietic cells, and molecular analysis of tissue expression has confirmed the broad expression of KIAA0020.

The amino acid sequences of 2 H-Y antigens identified by peptide elution corresponded to sequences encoded by the *SMCY* gene, which shares 85% identity at the amino acid level with a homologous X-chromosome gene, *SMCX*. The HLA-A2-restricted *SMCY* epitope, FKDICQV, was found to contain a modification of the cysteine residue at position 7, consisting of the attachment of a second cysteine via a disulfide bond.<sup>18</sup> A third H-Y antigen presented by HLA-A1 was recently shown to be encoded by the *DFFRY* gene.<sup>19</sup>

cDNA expression cloning has also been used successfully to identify genes encoding CD8<sup>+</sup> CTL-defined mHAgs. This approach involves cotransfection of antigen-negative target cells with pools of cDNA from a library derived from an

antigen-positive cell and a cDNA encoding the MHC class I restricting allele. The proteins expressed by the introduced cDNAs will be processed and the derived peptides presented with the introduced MHC class I molecule. Recognition of the transfected cells by T cells can be assessed by cytokine release into the media, and cDNA pools inducing a positive response are then progressively subdivided and screened in an identical fashion until a single cDNA encoding the antigen is identified. cDNA expression cloning has been used to identify the gene encoding the HB-1 mHAg<sup>10</sup> and a gene (human nucleophosphoprotein) encoding a mHAg presented by HLA-A3 (Gavin M, Warren EH, unpublished data). Our lab has also combined deletion mapping and cDNA transfection to identify an epitope in the *Uty* gene that is presented by HLA-B8.<sup>11</sup> The recipient did not develop clinical GVHD, and the *Uty*-specific CTL lysed only hematopoietic cells and not cells from nonhematopoietic tissues. Based on the large number of mHAg-specific T-cell clones now available, it is anticipated that many additional genes encoding mHAg will soon be identified.

### ROLE OF mAgS IN GVHD

The availability of mHAg-specific T-cell clones and the identification of the polymorphic genes encoding mHAgS has made it possible to begin to examine the role of individual antigens in GVHD. A study was conducted in which T-cell clones were used to tissue type donors and recipients to detect donor/recipient mismatching for HA-1, -2, -4, or -5.<sup>21</sup> This finding was initially surprising because cells derived from tissues that are targets of GVHD were not recognized by HA-1-specific CTLs in vitro. However, in a subsequent study in which >200 donor-recipient pairs were genotyped for HA-1 also found an association between HA-1 mismatching and acute GVHD,<sup>22</sup> an analysis of the frequency of HA-1-specific T cells in the blood of HCT recipients using HLA A2/HA-1 tetramer complexes demonstrated an association between high levels of HA-1-specific T cells and GVHD.<sup>23</sup> It is still unclear whether HA-1 is the actual target of T cells mediating GVHD or whether recognition of HA-1 on resident host hematopoietic cells serves to initiate inflammation and leads to the recruitment of T cells specific for other mHAgS involved in the GVH response. These results suggest that efforts to augment GVL responses using HA-1-specific T cells should proceed cautiously and use a suicide gene to permit ablation of the cells if severe GVHD were to occur.

Minor H antigens with broad or ubiquitous expression in tissues have also been implicated in GVHD. Using HLA-A2 and HLA-B7 tetramers complexed to SMCY epitopes, Mutis et al.<sup>23</sup> demonstrated a highly significant correlation between elevated levels of SMCY-specific CTLs and acute GVH. Similarly, elevated levels of HA-8-specific CTLs were detected by tetramer staining in the blood of a patient who developed multisystem chronic GVHD (Akatsuka Y, Riddell SR, unpublished

data). These correlative studies illustrate how the identification of mHAg peptides and the genes encoding them can be used to decipher the role of individual mHAgs in GVHD.

### **ROLE OF mHAgs IN GVL**

The analysis of antileukemic activity of mHAg-specific T-cell clones has until recently relied largely on in vitro assays of T-cell recognition of leukemic cells. mHAg-specific T-cell clones have been shown to lyse leukemic blasts in vitro and to inhibit the outgrowth of leukemic colonies in soft agar, demonstrating that mHAgs are expressed on at least a proportion of the leukemic blast population.<sup>4,24,25</sup> However, the leukemic cell population is composed of a hierarchy, with subsets of cells differing in their potential for self-renewal, and the putative leukemic stem cell is present in very low frequency ( $<1/10^5$  cells) in blood or bone marrow samples from AML patients.<sup>26,27</sup> Thus, in vitro assays would not be sufficiently sensitive to assess recognition of early leukemic progenitors to lysis by mHAg-specific T cells. We have used an in vivo model in which human AML samples are engrafted into NOD/SCID mice to determine if leukemic hematopoiesis can be eliminated by mHAg-specific CTLs. These studies show that the engraftment of AML can be specifically prevented by CD8<sup>+</sup> CTL clones specific for mHAgs that exhibit tissue-restricted expression in vitro, demonstrating that leukemic stem cells express such mHAgs and can be eliminated by CTL.<sup>28</sup> Engraftment of stem cells that do not express the mHAg was not affected by CTL, suggesting that administering mHAg-specific T cells to BMT recipients should not interfere in a nonspecific fashion with engraftment of donor hematopoietic cells.

### **ADOPTIVE T-CELL THERAPY USING mHAg-SPECIFIC T-CELL CLONES**

Despite the intensive chemoradiotherapy regimen administered to patients receiving allogeneic BMT for acute leukemia, relapse remains a major obstacle.<sup>29</sup> We have initiated a study for patients with advanced AML or ALL in which T-cell clones specific for recipient mHAgs are prospectively isolated after transplant and stored for potential use in adoptive immunotherapy if the patient relapses. To ensure safety, the *HSV-TK* gene is introduced into the T-cell clones to permit their ablation in vivo by the administration of ganciclovir. This strategy has been used successfully to ameliorate GVHD that occurs following adoptive immunotherapy with unselected polyclonal donor lymphocytes modified with *TK*.<sup>30</sup> The objectives of this study are to define mHAgs that can be safely targeted by adoptive T-cell therapy and to determine if this approach has antileukemic activity. It is anticipated that additional mHAgs and the genes encoding them will be identified in the future,

providing new insights into the role of specific T-cell responses in GVHD and GVL responses and new opportunities to manipulate these responses to improve the outcome of allogeneic HCT.

## REFERENCES

1. Horowitz MM, Gale RP, Sondel PM, et al. Graft-versus-leukemia reactions after bone marrow transplantation. *Blood* 75:555–562, 1990.
2. Giralt S, Estey E, Albitar M, et al. Engraftment of allogeneic hematopoietic progenitor cells with purine analog-containing chemotherapy: harnessing graft-versus-leukemia without myeloablative therapy. *Blood* 89:4531–4536, 1997.
3. Carella AM, Champlin R, Slavin S, McSweeney P, Storb R. Mini-allografts: ongoing trials in humans [editorial]. *Bone Marrow Transplant* 25:345–350, 2000.
4. Warren EH, Greenberg PD, Riddell SR. Cytotoxic T-lymphocyte-defined human minor histocompatibility antigens with a restricted tissue distribution. *Blood* 91:2197–2207, 1998.
5. Goulmy E. Human minor histocompatibility antigens: new concepts for marrow transplantation and adoptive immunotherapy. *Immunol Rev* 157:125–140, 1997.
6. De Bueger M, Bakker A, van Rood JJ, Van der Woude F, Goulmy E. Tissue distribution of human minor histocompatibility antigens: ubiquitous versus restricted tissue distribution indicates heterogeneity among human cytotoxic T lymphocyte-defined non-MHC antigens. *J Immunol* 149:1788–1794, 1992.
7. Goulmy E. Minor histocompatibility antigens from T cell recognition to peptide identification. *Hum Immunol* 54:8–14, 1997.
8. Van Els CA, D'Amato J, Pool J, et al. Immunogenetics of human minor histocompatibility antigens: their polymorphism and immunodominance. *Immunogenetics* 35:161–165, 1992.
9. Dolstra H, Fredrix H, Preijers F, et al. Recognition of a B cell leukemia-associated minor histocompatibility antigen by CTL1. *J Immunol* 158:560–565, 1997.
10. Dolstra H, Fredrix H, Maas F, et al. A human minor histocompatibility antigen specific for B cell acute lymphoblastic leukemia. *J Exp Med* 189:301–308, 1999.
11. Warren EH, Gavin MA, Simpson E, et al. The human UTY gene encodes a novel HLA-B8-restricted H-Y antigen. *J Immunol* 164:2807–2814, 2000.
12. Gubarev MI, Jenkin JC, Leppert MF, et al. Localization to chromosome 22 of a gene encoding a human minor histocompatibility antigen. *J Immunol* 157:5448–5454, 1996.
13. Hunt DF, Henderson RA, Shabanowitz J, et al. Characterization of peptides bound to the class I MHC molecule HLA-A2.1 by mass spectrometry. *Science* 255:1261–1263, 1992.
14. Boon T, Cerottini JC, Van den Eynde B, van der Bruggen P, Van Pel A. Tumor antigens recognized by T lymphocytes. *Ann Rev Immunol* 12:337–365, 1994.
15. Den Haan JMM, Sherman NE, Blokland E, et al. Identification of a graft versus host disease-associated human minor histocompatibility antigen. *Science* 268:1476–1480, 1995.
16. Den Haan JMM, Meadows LM, Wang W, et al. The minor histocompatibility antigen HA-1: a diallelic gene with a single amino acid polymorphism. *Science* 279:1054–1057, 1998.



17. Wang W, Meadows LR, den Haan JM, et al. Human H-Y: a male-specific histocompatibility antigen derived from the SMCY protein. *Science* 269:1588–1590, 1995.
18. Meadows L, Wang W, den Haan JM, et al. The HLA-A\*0201-restricted H-Y antigen contains a posttranslationally modified cysteine that significantly affects T cell recognition. *Immunity* 6:273–281, 1997.
19. Pierce RA, Field ED, den Haan JM, et al. Cutting edge: the HLA-A\*0101-restricted HY minor histocompatibility antigen originates from DFFRY and contains a cysteinylated cysteine residue as identified by a novel mass spectrometric technique. *J Immunol* 163: 6360–6364, 1999.
20. Mutis T, Verdijk R, Schrama E, Esendam B, Brand A, Goulmy E. Feasibility of immunotherapy of relapsed leukemia with ex vivo-generated cytotoxic T lymphocytes specific for hematopoietic system-restricted minor histocompatibility antigens. *Blood* 93:2336–2341, 1999.
21. Goulmy E, Schipper R, Pool J, et al. Mismatches of minor histocompatibility antigens between HLA-identical donors and recipients and the development of graft-versus-host disease after bone marrow transplantation. *N Engl J Med* 334:281–285, 1996.
22. Tseng LH, Lin MT, Hansen JA, et al. Correlation between disparity for the minor histocompatibility antigen HA-1 and the development of acute graft-versus-host disease after allogeneic marrow transplantation. *Blood* 94:2911–2914, 1999.
23. Mutis T, Gillespie G, Schrama E, Falkenburg JH, Moss P, Goulmy E. Tetrameric HLA-class I-minor histocompatibility antigen peptide complexes demonstrate minor histocompatibility antigen-specific cytotoxic T lymphocytes in patients with graft-versus-host disease. *Nat Med* 5:839–842, 1999.
24. Falkenburg JH, Goselink HM, van der Harst D, et al. Growth inhibition of clonogenic leukemic precursor cells by minor histocompatibility antigen-specific cytotoxic T lymphocytes. *J Exp Med* 174:27–33, 1991.
25. Van der Harst D, Goulmy E, et al. Recognition of minor histocompatibility antigens on lymphocytic and myeloid leukemic cells by cytotoxic T-cell clones. *Blood* 83:1060–1066, 1994.
26. Bonnet D, Dick JE. Human acute myeloid leukemia is organized as a hierarchy that originates from a primitive hematopoietic cell. *Nat Med* 3:730–737, 1997.
27. Lapidot T, Sirard C, Vormoor J, et al. A cell initiating human acute myeloid leukemia after transplantation into SCID mice. *Nature* 367:645–648, 1994.
28. Bonnet D, Warren EH, Greenberg PD, Dick JE, Riddell SR. CD8<sup>+</sup> minor histocompatibility antigen-specific cytotoxic T lymphocyte clones eliminate human acute myeloid leukemia stem cells. *Proc Natl Acad Sci U S A* 96:8639–8644, 1999.
29. Appelbaum FR. Allogeneic hematopoietic stem cell transplantation for acute leukemia. *Semin Oncol* 24:114–123, 1997.
30. Bonini C, Ferrari G, Verzeletti S, et al. HSV-TK gene transfer into donor lymphocytes for control of allogeneic graft-versus-leukemia. *Science* 276:1719–1724, 1997.

# Nonmyeloablative Transplants to Deliver Allogeneic Immunotherapy for Malignant Disease

*John Barrett, Richard Childs*

*Stem Cell Allograft Transplantation Unit, National Heart, Lung, and Blood Institute,  
National Institutes of Health, Bethesda, Maryland*

## ABSTRACT

We treated 80 patients with hematologic and nonhematologic malignancies with a low-intensity preparative regimen of cyclophosphamide 120 mg/kg and fludarabine 125 mg/m<sup>2</sup> followed by an unmanipulated peripheral blood stem cell transplant from an HLA-matched or closely matched family member. Seventy-seven patients (96%) engrafted. The main transplant-related complication was grade II–IV graft-vs.-host disease (GVHD) occurring in 50% of patients. Transplant-related mortality (TRM) was strongly affected by age: patients below the median age of 48 years had a 2.5% TRM compared with 36% for older patients ( $P=0.005$ ). Overall, 40 patients survive with an actuarial probability of  $35 \pm 7\%$ . There was evidence for a graft-vs.-malignancy (GVM) effect in patients with chronic myelogenous leukemia (CML), myelodysplastic syndrome (MDS), B-cell malignancies, and metastatic renal cell cancer (RCC); however, 8 patients with malignant melanoma showed no sustained disease response. Because nonmyeloablative conditioning was used, the sustained disease responses in RCC and molecular remissions in CML indicate a powerful alloimmune GVM effect in this type of transplant.

## INTRODUCTION

In the last decade, it has become increasingly clear that at least part of the therapeutic potential of allogeneic stem cell transplantation (SCT) is derived from an immune response of donor cells against the malignancy.<sup>1-2</sup> Evidence for the existence of a powerful GVM effect in a widening group of malignant diseases has brought about a revolution in the perception of stem cell allotransplants as a means not only to eliminate malignancy by myeloablative high-dose therapy but also to confer a GVM effect from alloreacting immune cells.<sup>3-5</sup> The current vogue in the application of nonmyeloablative transplants in hematologic and nonhematologic malignancies owes its origin in part to this concept of exploiting GVM effects to

cure malignant disease and in part to the perceived improvement in TRM achieved by reducing the intensity of the preparative regimen.<sup>6-8</sup> For these reasons, we used a low-intensity preparative regimen to treat patients with malignant disease. We mainly selected patients already resistant to dose escalation with chemotherapy and radiotherapy, in whom a GVM effect remained the only possible means of cure, or elderly or debilitated patients in whom a reduced risk from regimen-related mortality was particularly indicated.

## PATIENTS AND METHODS

We used a preparative regimen of cyclophosphamide 60 mg/kg on 2 successive days, followed by fludarabine 25 mg/m<sup>2</sup> for 5 days. Patients received a stem-cell- and T-cell-rich transplant of  $>5 \times 10^6$  CD34<sup>+</sup> and approximately  $5 \times 10^8$  CD3<sup>+</sup> cells/kg. GVHD prophylaxis was primarily with cyclosporine, tapered as rapidly as possible after day 30. GVHD prophylaxis was guided by monitoring T-cell chimerism such that prophylaxis was withdrawn to increase donor T-cell engraftment but continued if full T-cell engraftment had already been established by day 30. The aim of posttransplant immune manipulation was to achieve 100% donor T-cell chimerism within the first 100 days.

Between November 1997 and March 2000, we treated 80 patients with this regimen. Age range was 15–68 years (median, 48 years). Follow-up ranged from 3 to 28 months. Seventy-seven patients had an HLA-matched family donor, and 3 received transplants from an HLA 5/6-matched family member. Thirty-three patients had hematologic malignancies, 7 with chronic myelogenous leukemia in first chronic phase (CML CP1), 5 CML CP2, 10 MDS, 4 relapsed non-Hodgkin's lymphoma (NHL), 1 angioimmunoblastic lymphadenopathy, 2 relapsed Hodgkin's disease, 2 fludarabine-resistant chronic lymphocytic leukemia (CLL), and 2 multiple myeloma. Forty-four had metastatic solid tumors (32 renal cell cancer, 8 melanoma, 4 other). Three patients were transplanted for nonmalignant hematologic disorders (2 severe aplastic anemia, 1 paroxysmal nocturnal hemoglobinemia [PNH]).

## RESULTS

### Engraftment

Seventy-seven patients showed stable lymphoid and myeloid engraftment. Three patients rejected the transplant, recovered autologous hematopoiesis, and had progressive disease, from which 1 patient died. Seven patients received donor lymphocytes in an attempt to increase donor T-cell chimerism. Posttransplant blood and platelet transfusion support was not required in almost half the patients.

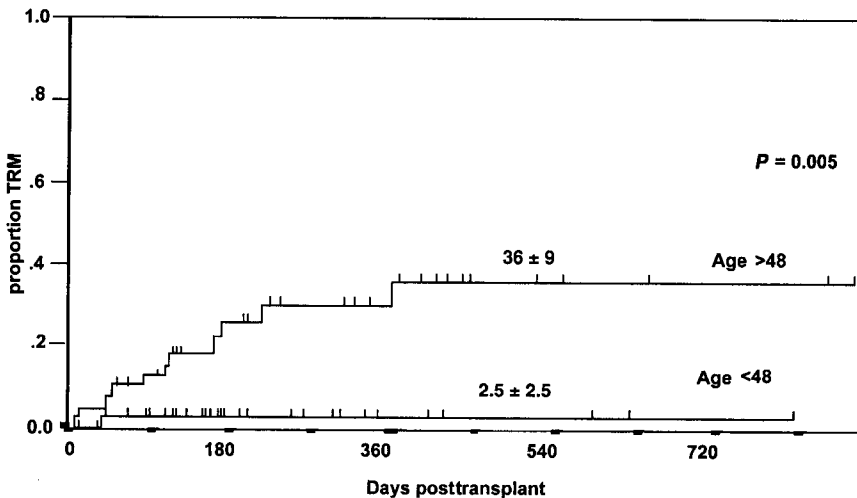
Neutrophil nadirs were typically short, with recovery to 1000/mm<sup>3</sup> at a median of 15 days. Chimerism data and hematologic recovery in the first 14 patients have been reported in detail.<sup>9</sup>

### Graft-vs.-Host Disease

The most frequent complication posttransplant was grade II–IV acute GVHD occurring in 35 patients (actuarial probability 50%). Of these, 16 (28%) had grade II–IV acute GVHD. There was no difference in the frequency of severe acute GVHD (grade III–IV) according to age (25% vs. 20% for patients less than 48 years old).

### Survival and TRM

Forty patients survive (actuarial probability of 35% ± 7%). Twenty-seven patients died from disease progression. Thirteen (actuarial probability 27%) died from transplant-related causes. The main cause of TRM was GVHD (8 acute, 1 chronic) (actuarial probability 17% ± 6%). TRM was strongly affected by age: patients below the median age of 48 years had a 2.5% TRM compared with 36% for older patients ( $P=0.005$ ) (Figure 1). The difference in survival was attributed to a higher mortality from GVHD in older patients (7 of 40 vs. 1 of 40 for patients under 48 years;  $P=0.05$ ).



**Figure 1.** Age and transplant-related mortality (TRM).

**Table 1.** Outcome: Summary\*

	<i>n</i>	<i>Response</i>	<i>Survival</i>	<i>Cause of Death</i>	
				<i>Disease Progression</i>	<i>TRM</i>
Metastatic renal cell carcinoma	32	11	16	12	4
Metastatic melanoma	8	0	0	6	2
CML CP1	7	4	7	0	0
CML CP2	5	1	3	2	0
MDS	10	3	4	2	2
B-cell malignancy	11	6	6	1	4
Other metastatic tumors	4	0	1	2	1
Aplastic anemia/PNH	3	3	3	0	0

\*CML, chronic myelogenous leukemia; CP, chronic phase; MDS, myelodysplastic syndrome; PNH, paroxysmal nocturnal hemoglobinemia; TRM, transplant-related mortality.

### Disease Response—Hematologic Malignancy

Sustained remissions were achieved in 4 of 7 patients with CML transplanted in CP1. Three are now in molecular remission (2 of these were previously reported in detail<sup>10</sup>). One patient has stable mixed chimerism (90% donor T cells) and persisting CP CML; the other rejected the transplant and remains in CP. Five patients with CML in CP2 were transplanted. One remains in hematologic and karyotypic remission (Table 1).

Four patients relapsed, 2 with myeloid and 2 with lymphoid blast crisis. The latter two survive in a further remission in CP. Three of 10 patients with MDS achieved hematologic remission with 100% donor chimerism. Six of 11 patients with B-cell malignancies achieved sustained remission, including 3 with NHL, 1 with angioimmunoblastic lymphadenopathy, 1 with CLL, and 1 with Hodgkin's disease. However, 4 (including 2 responders) died from transplant-related causes (Table 1).

### Disease Response—Solid Tumors

Eleven of 32 patients with renal cell cancer have responded. Four of these patients survive between 16 and 28 months with no detectable disease. Seven patients continue to show disease reduction on serial scans. The first 19 patients have been reported in detail.<sup>11,12</sup> In contrast, none of the 8 patients transplanted for malignant melanoma showed a durable response. Four patients received transplants for metastatic soft-tissue sarcoma (2), colonic adenocarcinoma (1), and adenocarcinoma with unknown primary (1). Two patients died of disease progression and 1

from acute GVHD, and 1 sarcoma patient is alive 60 days posttransplant with stable disease.

## DISCUSSION

The dramatic responses and sustained remissions seen notably in CML, NHL, and renal cell cancer provide strong evidence that a GVM effect can be both necessary and sufficient to achieve cure in a variety of hematologic and nonhematologic malignancies. There is evidence from the timing of the response that it was immune-mediated: responses began to occur beyond 60 days from transplant, they occurred only in the presence of full donor T-cell chimerism, and most patients who responded also had acute GVHD grade II–IV.<sup>9</sup>

Although it could be argued that mortality from a standard transplant approach would have been higher in this patient population, our results in 80 recipients of this cyclophosphamide/fludarabine protocol clearly indicate an unfavorable impact of older age on transplant outcome. This appeared to be mainly due to a higher risk of mortality from acute GVHD in older recipients. For this reason, we are now evaluating additional GVHD prophylaxis with mycophenolate mofetil.<sup>13</sup> However, the possible negative impact of increased GVHD prophylaxis on GVM requires careful monitoring. In the future, we plan to reduce TRM while conserving GVM by selective depletion of GVHD-reacting donor T cells<sup>14</sup> and by adoptive immunotherapy with tumor-specific alloreacting T cells.

## REFERENCES

1. Horowitz MM, Gale RP, Sondel PM, et al. Graft-versus-leukemia reactions after bone marrow transplantation. *Blood* 75:555–567, 1990.
2. Van Rhee F, Kolb H-J. Donor leukocyte transfusions for leukemic relapse. *Curr Opin Hematol* 2:423–431, 1995.
3. Carella AM, Champlin R, Slavin S, McSweeney P, Storb R. Mini-allografts: ongoing trials in humans. *Bone Marrow Transplant* 25:345–350, 2000.
4. Champlin R, Khouri I, Kornblau S, Mollidrem J, Giralt S. Reinventing bone marrow transplantation: reducing toxicity using nonmyeloablative preparative regimens and induction of graft-versus-malignancy. *Curr Opin Oncol* 11:87–95, 1999.
5. Giralt S, Estey E, Albitar M, et al. Engraftment of allogeneic hematopoietic progenitor cells with purine analog-containing chemotherapy: harnessing graft-versus-leukemia without myeloablative therapy. *Blood* 89:12–20, 1997.
6. Khouri IF, Keating M, Korblyng M, et al. Transplant-lite: induction of graft-versus-malignancy using a fludarabine-based nonablative chemotherapy and allogeneic blood progenitor transplantation as treatment for lymphoid malignancy. *J Clin Oncol* 8:2817–2824, 1998.
7. Slavin S, Nagler A, Naporstek E, et al. Nonmyeloablative stem cell transplantation and

- cell therapy as an alternative to conventional bone marrow transplantation with lethal cytoreduction for the treatment of malignant and nonmalignant hematologic diseases. *Blood* 91:756–763, 1998.
8. Keleman E, Masszi T, Remenyi P, Barsta A, Paloczi K. Reduction in the frequency of transplant-related complications in patients with chronic myeloid leukemia undergoing BMT preconditioned with a new non-myeloablative drug combination. *Bone Marrow Transplant* 21:747–749, 1998.
  9. Childs R, Clave E, Jayasekara D, et al. Full donor T-lymphocyte chimerism predicts for graft-vs-host disease, graft-vs-marrow and graft-vs-malignancy effects following a non-myeloablative preparative regimen. *Blood* 94:3234–3241, 1999.
  10. Childs R, Epperson D, Bacheci E, et al. Molecular remission of chronic myelogenous leukemia following a non-myeloablative allogeneic peripheral blood stem cell transplant: in vivo and in vitro evidence for a graft-versus-leukemia (GVL) effect. *Br J Haematol* 107:396–400, 1999.
  11. Childs R, Clave E, Tisdale J, Plante M, Hensel N, Barrett AJ. Successful treatment of metastatic renal-cell carcinoma with a non-myeloablative allogeneic peripheral blood progenitor cell transplant: evidence for a graft-versus-tumor effect. *J Clin Oncol* 17:2044–2046, 1999.
  12. Childs R, Clave E, Plante M, Tisdale J, Barrett AJ. Treatment of metastatic renal-cell carcinoma with non-myeloablative allogeneic peripheral blood progenitor cell transplants. *N Engl J Med*. In press.
  13. Yu C, Seidel K, Nash RA, et al. Synergism between mycophenolate mofetil and cyclosporine in preventing graft-versus-host disease among lethally-irradiated dogs given DLA-nonidentical unrelated marrow grafts. *Blood* 91:2581–2587, 1998.
  14. Mavroudis DA, Dermime S, Molldrem JJ, et al. Specific depletion of alloreactive T cells in HLA-identical siblings: a method for separating graft-vs-host and graft-vs-leukaemia reactions. *Br J Haematol* 101:565–570, 1998.

# Fludarabine-Based Nonmyeloablative Transplantation for Hematologic Malignancies

*Issa Khouri, Sergio Giralt, Richard Champlin*

*Department of Blood and Marrow Transplantation, The University of Texas  
M.D. Anderson Cancer Center, Houston, Texas*

## INTRODUCTION

High-dose chemoradiotherapy and irradiation are responsible for most of the treatment-related morbidity and mortality associated with conventional stem cell transplantation and restrict the use of conventional transplantation to younger, fitter patients. Nonmyeloablative allogeneic stem cell transplantation (NST) was developed after the observation that donor lymphocyte infusions could overcome relapse in patients who had received allogeneic transplants for hematologic malignancies.<sup>1-3</sup> If donor lymphocytes can control, or even eradicate, malignant cells that have proven resistant to high-dose chemotherapy and irradiation, then these highly toxic therapies may not be necessary for the success of allogeneic stem cell transplantation strategies. The aim of NST is to use low-intensity preparative regimens to induce immunosuppression in the recipient. This immunosuppression allows donor cells to engraft, creating a hematopoietic chimera. This will generate a platform for cellular immunotherapy, with donor lymphocytes as the active agents.

Fludarabine is a purine analog with potent immunosuppressive properties.<sup>4,5</sup> In addition, it has antitumor activity against a range of hematologic malignancies, thus allowing disease control until the initiation of graft-vs.-malignancy after transplantation. For these reasons, we chose fludarabine as a backbone component for our NST protocols.

## NST FOR MYELOID MALIGNANCIES

In a phase 1 trial based at the M.D. Anderson Cancer Center, 45 patients with either acute myeloid leukemia (AML)/myelodysplastic syndrome (MDS) or chronic myeloid leukemia (CML) were treated with NST.<sup>6</sup> The 2 regimens used are outlined in Figure 1. Patients without prior fludarabine exposure received FLAG-Ida (fludarabine, cytosine arabinoside, and idarubicin). Those with prior exposure to fludarabine received cladribine and cytosine arabinoside. Patients were not eligible for conventional transplants because of their age or comorbid conditions;



most were in second or subsequent relapse or refractory to prior treatment (Table 1).

Most patients ( $n = 34$ ) received the FLAG-Ida regimen (Figure 1). Median age was 60 years (range, 29–75 years). Prophylactic treatment for graft-vs.-host disease (GVHD) consisted initially of cyclosporine and methylprednisolone, but was later switched to tacrolimus and minidose methotrexate. Engraftment occurred in 39 patients, with the median percentage of donor cells at 95% on day 30 and 97.5% on day 120. By 6 months, 16 patients remained in complete response with donor cell engraftment.

The incidence and severity of GVHD were not as high as had been anticipated in this study. In 38 evaluable patients, there were 5 cases of grade 2, 4 cases of grade 3–4, and 3 deaths from GVHD. For patients with a low tumor burden (no peripheral blood blasts and <10% bone marrow blasts) before transplant, the probability of disease-free survival was very encouraging: 40% at 2 years. Results were disappointing in patients with high tumor bulk, most of whom experienced rapid relapse; there was only one such patient surviving at 2 years.

**Table 1.** Nonmyeloablative Allogeneic Stem Cell Transplantation for Myeloid Malignancies: Patient Characteristics\*

	<i>Purine Analog/ Ara-C Regimens</i>	<i>Purine Analog/ Melphalan Regimens</i>
Patients	45	83
Age, y	60 (29–75)	54 (24–70)
Diagnosis		
AML/MDS	35	50
CML	10	33
Cytogenetics (diploid), %	27	48
Time to transplant, mo	15 (4–114)	15 (1–220)
Number of prior treatments	2 (1–3)	2 (1–8)
Prior transplant	0	17
Comorbidity, %	60	47
Donor		
Matched related	35	38
Mismatched related	10	5
Matched unrelated	—	40
Preparative regimen		
Fludarabine-based	34	77
Cladribine-based	11	6

\*Data are  $n$  or median (range) unless otherwise indicated. AML, acute myeloid leukemia; Ara-C, cytosine arabinoside; CML, chronic myeloid leukemia; MDS, myelodysplastic syndrome.

Days	-5	-4	-3	-2	-1	0
<b>FLAG-Ida</b>						
Fludarabine 30 mg/m <sup>2</sup>	F	F	F	F		T
Cytarabine 2 g/m <sup>2</sup>	Cy	Cy	Cy	Cy		R
Idarubicin 12 mg/m <sup>2</sup>	I	I	I	I		A
<b>Cladribine + cytarabine</b>						N
Cladribine 12 mg/m <sup>2</sup> c.i.	Cl	Cl	Cl	Cl	Cl	S
Cytarabine 1 g/m <sup>2</sup>	Cy	Cy	Cy	Cy	Cy	P
						L
						A
						N
						T

**Figure 1.** Nonmyeloablative preparative regimens in AML/MDS or CML patients.

In a subsequent phase 1 trial, a more intensive regimen consisted of a combination of melphalan and a purine analog (Figure 2).<sup>7</sup> This trial involved mainly patients with advanced disease (Table 1). Also, ~50% of these patients (40 of 83) received a transplant from an unrelated donor. Patients received either fludarabine/melphalan or cladribine/melphalan preparative regimens (Figure 2).

The cladribine arm of the study was closed early because of excessive toxicity. GVHD prophylaxis regimen was tacrolimus and minidose methotrexate. Most patients showed donor engraftment, and all patients who had mixed chimerism at day 30 showed complete donor-derived hematopoiesis at 3 months, either through gradual spontaneous evolution or subsequent to the withdrawal of immunosuppression.

There was 1 graft failure and 1 autologous recovery among patients with unrelated donors, an indication that immunosuppressive regimens may need to be more stringent when there is more genetic disparity between donors and recipients. The incidence of GVHD was higher in patients with unrelated donors than in those with related donors, as would be expected, with 5 deaths from GVHD among 38 evaluable patients with related donors and 12 deaths among 39 patients with unrelated donors. In comparing the trials, the more intensive regimen was also associated with a higher incidence of GVHD. More patients with matched unrelated donors were included in the second trial, but a difference in GVHD was seen even when the comparison was restricted to patients with matched sibling donors. However, greater intensity of conditioning may be necessary to achieve disease control.

As in the previous trial, the most important prognostic factor for clinical response was the stage of disease at transplant. Approximately 20% of patients with advanced refractory high-risk disease, and almost 70% of patients with low-risk disease, were alive at a median of ~2 years. These results are comparable with those obtained with conventional transplants in younger, fitter patients. In addition,

Days	-5	-4	-3	-2	-1	0
<b>Melphalan + fludarabine</b>						T
Fludarabine 30 mg/m <sup>2</sup>	F	F	F	F	F	R
Melphalan 70 or 90 mg/m <sup>2</sup>				M	M	A
<b>Melphalan + cladribine</b>						S
Cladribine 12 mg/m <sup>2</sup>	C	C	C	C	C	P
Melphalan 90 mg/m <sup>2</sup>				M	M	L
						A
						N
						T

**Figure 2.** *Reduced intensity preparative regimens in AML/MDS or CML patients.*

these results suggest that the more intensive purine analog alkylator regimen can be seen to result in a better outcome in patients with high-risk disease than the low-intensity purine analog cytosine arabinoside regimen used in the first trial, whereas these regimens gave similar results in patients with low-risk disease.

### NST FOR LYMPHOID MALIGNANCIES

Indolent lymphoid malignancies have also proven to be attractive target diseases for graft-vs.-malignancy and NST strategy.<sup>8,9</sup> The use of allogeneic transplantation has been limited in these disorders, because they typically affect older and often debilitated patients.

Ten patients with indolent lymphomas who were not eligible for myeloablative transplant regimens because of age, comorbidity, or poor performance status were treated. They received fludarabine 125 mg/m<sup>2</sup> and cyclophosphamide 2 g/m<sup>2</sup> (Figure 3) with allogeneic hematopoietic transplantation from an HLA-identical sibling.<sup>10,11</sup> Seven had follicular small-cleaved, 2 follicular mixed, and 1 small lymphocytic lymphoma. Median age was 50 years (range, 36–60 years). The median number of prior chemotherapy regimens was 2 (range, 1–6). One patient had hepatitis C and had failed to engraft with an allogeneic blood stem cell transplant from a different donor. Eight had sensitive and 2 had chemotherapy-refractory disease at transplant. The median number of days of severe neutropenia (absolute neutrophil count [ANC] <0.5) was 6 days. Eight patients never required platelet transfusion. All patients engrafted. Donor cells >80% by restriction fragment length polymorphism were seen in 50% of patients by day 30 after transplant and in 90% of patients by day 100. No grade 2 or greater toxicity was observed. Acute GVHD grade 2 occurred in only 1 patient and was limited to the skin. All patients achieved complete remission, and none has relapsed. One patient who had refractory disease pretransplant had partial response by day 30 but

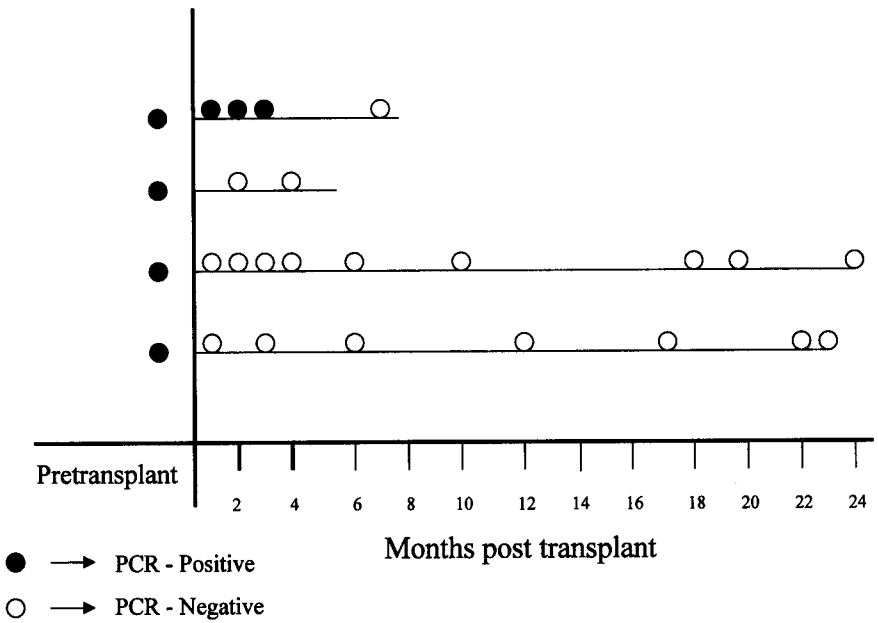
Days	-5	-4	-3	-2	-1	0
<b>FC</b>						T
Fludarabine 25 mg/m <sup>2</sup>	F	F	F	F	F	R
Cyclophosphamide 1 g/m <sup>2</sup>				Cy	Cy	A
<b>PFA</b>						N
Cisplatin 25 mg/m <sup>2</sup>		P	P	P	P	S
Fludarabine 30 mg/m <sup>2</sup>				F	F	L
Cytarabine 1 mg/m <sup>2</sup>				A	A	A
						N
						T

**Figure 3.** Preparative regimen in lymphomas.

achieved CR late with the onset of GVHD. Overall and event-free survival rates are both 100%, with a median follow up time of 16 months (range, 8.5–32 months).

Clonal cells were detected in 4 patients who were tested pretransplantation for lymphoma by marrow polymerase chain reaction (PCR) assay for *bcl-2* gene rearrangement. Patients were followed prospectively after transplant for the presence of minimal residual disease by PCR, at 1- to 3-month intervals. Results obtained from the analysis of 22 samples are summarized in Figure 4. Three were PCR negative. Only 1 patient had a PCR-positive status. She converted to PCR negativity at 7 months posttransplant concomitant with chronic GVHD. No correlation was observed between the degree of mixed chimerism and the status of molecular remission. One patient had only 10% donor cells at 1 month posttransplant, and another who was PCR-positive pretransplant converted to a PCR-negative status 1 month after transplantation with 60% donor cells. The observation that a PCR-negative status could be obtained in patients with mixed chimerism suggests that in indolent lymphoid malignancies, full chimerism is not needed to achieve optimal results. Thus, one should be cautious in administering donor lymphocyte infusions posttransplant, considering the risk of morbidity that can be associated with this procedure.

We evaluated the potential role of NST in lymphoma in patients with aggressive histologies who failed or who were not candidates for autologous transplantation. In a phase 2 study conducted at M.D. Anderson Cancer Center, 15 patients with aggressive lymphomas (diffuse large cell, 8; mantle cell, 4; and chronic lymphocytic leukemia in Richter's transformation, 3) were transplanted using the nonmyeloablative regimen of cisplatin (100 mg/m<sup>2</sup>), fludarabine (60 mg/m<sup>2</sup>), and cytosine arabinoside (2 mg/m<sup>2</sup>) (Figure 3).<sup>12</sup> Median age of patients was 55 years (range, 31–64 years), and all patients had received extensive prior chemotherapy for their disease. The number of prior chemotherapy regimens was 1–6 (median, 3).



**Figure 4.** PCR status posttransplant.

All patients were ineligible for myeloablative regimens because of age or other comorbidities (prior autologous transplantation, 3; cardiac, renal, or pulmonary dysfunction, 3; and poor performance status, 2). Nine patients were stage III/IV at the time of transplant, and 6 were refractory (or untested) to salvage therapy. The regimen was well tolerated. The median duration of severe neutropenia was 3 days, and the median requirement for platelet transfusions was 2 units. Fourteen of 15 patients engrafted with donor cells. More than 80% donor cells were present in the bone marrow of 6 patients at day 30 and 9 patients at day 100. One patient failed to engraft, and another developed secondary graft failure. Eight patients achieved a complete remission (53%), 2 achieved partial remission (13%), 4 had stable disease or minor response (26%), and 1 patient had progressive disease (6%). At a median follow-up of 1 year, 9 patients (60%) are alive and 6 patients (40%) are in remission. Five patients relapsed, but 2 achieved a complete remission, 1 after withdrawal of immunosuppression and 1 with rituximab therapy. Early toxicity was mainly infectious (5 patients), and 1 liver toxicity grade 2 was observed. Two patients developed acute GVHD (grade 1–2), and 3 developed chronic GVHD. These preliminary results are encouraging, given the patient population selected for the trial.

## CONCLUSION

Fludarabine-based nonmyeloablative hematopoietic transplantation is feasible in the elderly and in patients with comorbidities precluding standard ablative conditioning. Engraftment with donor cells occurs in most patients. A more intense regimen is needed for engraftment of unrelated donors and for patients with high tumor burden to allow time for the development of an effective graft-vs.-tumor effect. Further clinical trials are required for prospective comparison of this approach with other chemotherapy techniques.

## REFERENCES

1. Collins RG, Rogers ZR, Bennet M, et al. Hematologic relapse of chronic myelogenous leukemia following allogeneic transplantation: apparent graft-versus-leukemia effect following abrupt discontinuation of immunosuppression. *Bone Marrow Transplant* 10: 391–395, 1992.
2. Kolb HJ, Schattenberg A, Goldman JM, et al. Graft-versus-leukemia effect of donor lymphocyte infusions in marrow grafted patients. *Blood* 86:2041–2050, 1995.
3. Collins RH, Shpilberg O, Drobyski WR, et al. Donor leukocyte infusions in 140 patients with relapsed malignancy after allogeneic bone marrow transplantation. *J Clin Oncol* 15: 433–444, 1997.
4. Plunkett W, Sanders P. Metabolism and action of purine nucleoside analogs. *Pharmacol Ther* 49:239–245, 1991.
5. Estey E, Plunkett W, Gandhi V, et al. Fludarabine and arabinosylcytosine therapy of refractory and relapsed acute myelogenous leukemia. *Leuk Lymphoma* 9:343–350, 1993.
6. Giralt S, Estey E, Albitar M, et al. Engraftment of allogeneic hematopoietic progenitor cells with purine analog-containing chemotherapy: harnessing graft-versus-leukemia without myeloablative therapy. *Blood* 89:4531–4536, 1997.
7. Giralt S, Cohen A, Mehra R, et al. Preliminary results of fludarabine/melphalan or 2CDA/melphalan as preparative regimens for allogeneic progenitor cell transplantation in poor candidates for conventional myeloablative conditioning [abstract]. *Blood* 90:417a, 1997.
8. Van Besien KW, Khouri IF, Giralt SA, et al. Allogeneic bone marrow transplantation for refractory and recurrent low-grade lymphoma: the case for aggressive management. *J Clin Oncol* 13:1096–1102, 1995.
9. Van Besien K, Sobocinski KA, Rowlings PA, et al. Allogeneic bone marrow transplantation for low-grade lymphoma. *Blood* 92:1832–1836, 1998.
10. Khouri I, Keating M, Korbling M, et al. Transplant-lite: induction of graft-versus malignancy using fludarabine based nonablative chemotherapy and allogeneic blood progenitor-cell transplantation as treatment for lymphoid malignancies. *J Clin Oncol* 16: 2817–2824, 1998.
11. Khouri I, Lee M-S, Palmer L, et al. Transplant-lite using fludarabine-cyclophosphamide (FC) and allogeneic stem cell transplant (alloSCT) for low-grade lymphoma (LGL)

[abstract]. *Blood* 94 (Suppl 1):348a, 1999.

12. Khouri I, Giralt S, Saliba R, et al. "Mini"-allogeneic stem cell transplantation for relapsed/refractory lymphomas with aggressive histologies [abstract]. *Proc ASCO* 19:47a, 2000.

# **Massive Doses of CD34<sup>+</sup> Stem Cells Allow Significant Reduction in the Myeloablative Regimen Without Sacrificing Complete Chimerism in Matched Sibling Allogeneic Transplantation**

***Karel A. Dicke, Jami Mayorga, Deborah L. Livingston, Sylvia Hanks, Lorene K. Fulbright***

*Arlington Cancer Center, Arlington, Texas*

## **INTRODUCTION**

Peripheral blood progenitor cells from matched sibling donors have been used rather than bone marrow as an alternative source of stem cells. Not only more stem cells but also more lymphocytes are collected for transplantation, leading to a statistically shorter engraftment time and, surprisingly, not much more acute graft-vs.-host disease (GVHD), although the incidence of chronic GVHD is higher.<sup>1</sup> The M.D. Anderson group pioneered the use of smaller doses of conditioning agents to avoid treatment-related morbidity and mortality.<sup>2</sup> On the basis of their results, we began to use busulfan alone without the addition of cyclophosphamide or total body irradiation (TBI). Busulfan at 16 mg/kg is an effective single agent for acute and chronic myeloid leukemia.<sup>3</sup> We reasoned that with the infusion of a large number of peripheral blood stem cells (PBSCs), the need for immunosuppressive agents such as cyclophosphamide or TBI in the conditioning regimen could be avoided. We report here the results of the first 4 patients treated on a completely outpatient basis.

## **METHODS**

Patients were treated according to our allogeneic PBSC protocol approved by the Arlington Cancer Center Institutional Review Board. Patients were treated with busulfan 16 mg/kg in divided doses of 1 mg/kg po every 6 hours. Table 1 defines patient characteristics. Antiemetics such as ondansetron (Zofran) 32 mg intravenously (IV) per day and a combination of haloperidol (Haldol), lorazepam (Ativan), and diphenhydramine (Benadryl) was administered. The time interval between completion of busulfan and the initiation of infusion of PBSCs was 48 hours.



**Table 1.** Patients\*

Male	32 years old	CML benign phase, Ph <sup>+</sup>
Male	46 years old	CML benign phase, Ph <sup>+</sup>
Female	37 years old	AML 2nd remission, previous autologous transplant
Female	58 years old	AML 1st remission, no previous autologous transplant, leukemia secondary to breast cancer

\*AML, acute myeloid leukemia; CML, chronic myeloid leukemia; Ph, Philadelphia chromosome.

Peripheral blood stem cells were obtained from matched sibling donors after treating the donors with granulocyte colony-stimulating factor (G-CSF) 10  $\mu\text{g}/\text{kg}$  daily subcutaneously for 4–6 days. The CS3000 apheresis centrifuge was used for collecting stem cells. Up to 3 daily collections were necessary to obtain at least  $7 \times 10^6$  CD34<sup>+</sup> cells/kg. Cells were infused on separate but consecutive days. Table 2 depicts conditioning regimens and stem cell transplant. Table 3 depicts the phenotype analysis of transplanted cells. The anti-GVHD regimen consisted of solumedrol 25 mg IV every 24 hours beginning 1 day posttransplant for 30 days before tapering. Cyclosporine 1.3 mg/kg continuous IV infusion was administered starting 3 days before transplant. Serum levels were monitored and kept to 250–350 ng/mL for 6–8 months before tapering after 8 months. The antimicrobial prophylactic regimen is outlined in Table 4.

**Table 2.** Conditioning and Transplant Regimens\*

Conditioning regimen	
Busulfan, 16 mg/kg over 4 days	
No cyclophosphamide or TBI	
Stem cell transplant	
Donor	HLA-identical sibling, same sex
ABO typing, donor/recipient	O <sup>+</sup> /A <sup>+</sup> O <sup>+</sup> /AB <sup>-</sup> O <sup>+</sup> /O <sup>+</sup> A <sup>+</sup> /B <sup>+</sup>
Stem cell source	Peripheral blood apheresis after G-CSF (10 $\mu\text{g}/\text{kg}$ every 24 h $\times$ 6 d)
Number of cells, median (range)	$10.1 \times 10^6$ CD34 <sup>+</sup> cells/kg (7.7–13.3 $\times 10^6$ )
Infusion	48 and 72 h after final dose of busulfan

\*G-CSF, granulocyte colony-stimulating factor; TBI, total body irradiation.

**Table 3.** Phenotypic Analysis of Transplanted Cells

Method	Monoclonal antibody labeling and flow cytometry (CD34, CD19, CD3, CD4, CD8)
Acquisition	75,000 cells for CD34 analysis 5000 cells for lymphocyte analysis
Cell numbers per kg, median (range)	
CD34 <sup>+</sup> progenitors	$10.1 \times 10^6$ (7.7–13.3 $\times 10^6$ )
B lymphocytes	$9.4 \times 10^7$ (3.7–30.2 $\times 10^7$ )
T lymphocytes	$3.8 \times 10^8$ (3.0–7.5 $\times 10^8$ )
T4 lymphocytes	$2.6 \times 10^8$ (1.0–5.5 $\times 10^8$ )
T8 lymphocytes	$1.2 \times 10^8$ (1.0–2.0 $\times 10^8$ )

**Table 4.** Antimicrobial Prophylaxis

Vancomycin, 300 mg continuous IV q 24 h, serum levels $\geq 5$
Ceftriaxone (Rocephin), 2 g IV q 24 h
Levofloxacin (Levaquin), 500 mg q 24 h
Acyclovir, 5 mg/kg IV q 12 h
Valcyclovir (Valtrax), 500 mg po q 24 h
Fluconazole (Diflucan), 200 mg IV q 24 h
Amphotericin B (Ambisome), 100 mg IV Monday, Wednesday, Friday

**Table 5.** Engraftment, Transfusion Support, and Chimerism

Time to engraftment, d	
Absolute neutrophil count $>1000/\text{mm}^3$ , median (range)	11 (10–13)
Platelets $>50,000/\text{mm}^3$ , median (range)	14 (12–17)
Transfusion support	
Packed red cells	2 units for 1 patient
Platelets	8 units for 1 patient 16 units for 1 patient
Chimerism by restriction fragment length polymorphism	100% at 3–4 wk posttransplant, persisted for 9–19 mo

## RESULTS

The results of engraftment, transfusion support, and chimerism are depicted in Table 5. Engraftment was rapid, and the need for transfusion support was minimal. Chimerism was documented 3 weeks after transplant. Table 6 documents the GVH symptoms in the 4 patients. In 2 patients, grade I and II GVH symptoms were noted. One patient suffered from delayed acute GVHD after stopping anti-GVHD prophylaxis after 7 months. Table 7 documents the current status of the patients.

**Table 6.** Graft-vs.-Host Symptoms\*

Acute	
Grade I (1 patient)	Localized rash, joint aches; abdominal cramping without diarrhea
Grade II (1 patient)	Localized rash; diarrhea with confirmed ulcerations in ileum
Delayed acute	
Grade IV (1 patient)	Skin, liver, kidneys; mouth sores

*\*No veno-occlusive disease, adult respiratory distress syndrome, or grade III/IV acute graft-vs.-host disease was present.*

## DISCUSSION

Busulfan is an effective single agent for de novo acute myeloid leukemia (AML) and chronic myeloid leukemia (CML) with minimal extramedullary toxicity. Large numbers of mobilized peripheral stem cells can induce rapid engraftment and complete chimerism without cyclophosphamide or total body irradiation in the conditioning regimen. Acute GVHD can be minimized and managed on an outpatient basis using continuous IV cyclosporine and bolus IV solumedrol. We are investigating whether the addition of low-dose methotrexate in 3 divided doses during the first 10 days after engraftment reduces further GVHD without jeopardizing early engraftment. Neutropenic precautions and rigorous prophylactic antimicrobial therapy have averted early infectious complications and nearly eliminated inpatient admissions during the first 3 months after transplant. The total number of hospital days within 3 months after transplantation was 6 for the entire patient population. Complications such as recurrence of leukemia and delayed acute GVHD still remain.

**Table 7.** Current Status

- The first chronic myeloid leukemia (CML) patient (32 years old) died in complete remission at 19 months posttransplant from a myocardial infarction related to juvenile diabetes.
- The second CML patient (46 years old) died in complete remission at 6 months posttransplant from a pulmonary fungal infection arising from patient noncompliance to protocol.
- The first acute myeloid leukemia (AML) patient (37 years old) died 9 months posttransplant with delayed acute grade IV graft-vs.-host disease.
- The second AML patient (58 years old) relapsed at 5 months posttransplant and received donor lymphocytes but died from recurrent leukemia.

**REFERENCES**

1. Russell NH, Hunter A, Rogers S, Hanley J, Anderson D. Peripheral blood stem cells as an alternative to marrow for allogeneic transplantation [letter]. *Lancet* 341:1482, 1993.
2. Giralt S, Khouri I, Champlin R. Allogeneic progenitor cell transplantation after non-myeloablative conditioning. In: Dicke KA, Keating A, eds. *Autologous Blood and Marrow Transplantation: Proceedings of the Ninth International Symposium, Arlington, Texas*. Charlottesville, VA: Carden Jennings, 1999, p. 612–618.
3. Olavarria E, Kanfer E, Szydlo R, et al. High-dose busulfan alone as cytoreduction before allogeneic or autologous stem cell transplantation for chronic myeloid leukaemia: a single-centre experience. *Br J Haematol* 108:769–777, 2000.

# **CHAPTER 8**

**ALL**



# **Autologous Stem Cell Transplantation vs. Chemotherapy for Acute Lymphoblastic Leukemia in First Remission**

**Jacob M. Rowe**

*Department of Hematology and Bone Marrow Transplantation,  
Rambam Medical Center, Haifa, Israel*

## **ABSTRACT**

Over the past decade, considerable experience has been gained with autologous bone marrow transplantation (autoBMT) for acute myelogenous leukemia (AML), and it is becoming possible to identify the patients most likely to benefit from this approach. In contrast, in acute lymphoblastic leukemia (ALL), the precise role of autoBMT is much less clear, and there are few studies available from which to draw conclusions. This is an active area of clinical research, however, and the emerging data suggest that autoBMT has considerable promise in ALL. Formerly, most adult ALL patients who underwent bone marrow transplant did so in relapse, or in second or subsequent remission. The fact that some of these patients could become long-term survivors has encouraged the use of autoBMT in first remission. In most studies, 40%–50% of first-remission adult ALL patients attained long-term disease-free survival after autoBMT. Relapse rates are considerably higher in patients receiving autoBMT compared with those receiving an allogeneic transplant, but the latter group of patients experience significant morbidity and mortality due to graft-vs.-host disease (GVHD) and opportunistic infections. Autologous transplantation clearly has the potential to effect cures in patients with AML, and its role and timing are now the subject of major clinical studies. As the mortality of autoBMT for ALL in remission rapidly decreases to <5%, more widespread use of such a procedure may increase the number of long-term survivors of adult ALL and may replace the protracted maintenance therapy usually given in this disease.

## **INTRODUCTION**

Although the treatment of childhood ALL has improved dramatically over the past 30 years, advances in the therapy of ALL in adult patients has been less

striking. Although 70%–90% of adult ALL patients attain complete remission, only about 20–35% experience long-term disease-free survival.<sup>1–8</sup>

There are many reasons for this disparity in outcome. First, age is an extremely strong predictive factor, because increasing age is closely associated with a poorer outcome.<sup>9</sup> Second, older patients may have a decreased ability to withstand the inherent hematologic toxicity of many of the antileukemic drugs. Third, adult patients tend to have a greater frequency of subtypes that portend a worse prognosis, for example leukemias that are Philadelphia chromosome (Ph)-positive (20%–30% of adults vs. 3% of children) and early-lineage B-cell ALL.<sup>10–13</sup> It is not surprising, therefore, that new therapeutic modalities have been developed in an attempt to improve the overall results in adults with ALL. The experience in autologous transplantation for ALL appears to be much less well defined than for AML, and neither the appropriate indications nor the timing have yet been clearly determined. This article summarizes the available data and the major ongoing studies that are designed to elucidate the precise role of autoBMT for adult patients with ALL.

### **RATIONALE FOR THE USE OF AutoBMT**

Only about one third of patients will have a suitable histocompatible sibling who can be a donor for an allogeneic bone marrow transplant. The recent reports of the use of unrelated matched allogeneic donors<sup>14</sup> or transplants from haplo-identical donors<sup>15</sup> are promising. However, the therapy-related morbidity and mortality due to GVHD, graft failure, and infection are significantly greater than those observed when matched sibling donor marrow is used. This makes these procedures more difficult to conduct and, at least in early-stage disease, to recommend. Furthermore, more than half of adult ALL patients are at least 40 years of age, posing greater hazards for successful allogeneic bone marrow transplantation. As a result, autologous transplantation has been used with increasing frequency in ALL. This approach does not require a histocompatible donor, lacks the risk of GVHD, and can be performed in patients up to the age of 65–70 years.

There are many issues regarding the efficacy and toxicity of autologous transplants for adults with ALL in first remission. Will a transplant improve long-term disease-free survival and overall survival? Does the use of peripheral stem cells significantly affect and reduce morbidity and mortality from autologous transplants in first-remission ALL? There are also several important considerations for the overall outcome from autologous or peripheral stem cell transplants. Is it possible to improve on the standard chemotherapy? If overall improvement of survival is not possible, is a single course of autoBMT as good as standard protracted consolidation/maintenance therapy with perhaps less toxicity? Are there specific subtypes for whom this may be more appropriate? As for most studies of acute leukemia, the answer will likely be found here.



The question regarding the use of autologous transplantation in ALL may not be similar to AML. Whereas in AML the focus has been on demonstrating that autologous transplants must have an improved efficacy over conventional chemotherapy, the considerations in ALL may be different. Conventional consolidation/maintenance chemotherapy is protracted and toxic, significantly affecting the quality of life of many patients for a long time. With the advent of peripheral stem cell transplants and the significantly reduced morbidity and mortality from such autologous transplantation, it may well be that if a single course of intensive-dose chemotherapy with autologous transplant is at least as effective as protracted standard consolidation/maintenance therapy, a strong case may be made for its introduction as standard care.

### TO PURGE OR NOT TO PURGE?

Because of the potential for infusing residual leukemia cells in autologous bone marrow, many protocols routinely provide for *in vitro* treatment or purging of harvested marrow in an attempt to eliminate occult leukemia cells.<sup>16-18</sup> The role of *in vitro* purging is unclear, because the maneuver has not been demonstrated to enhance outcome.<sup>19</sup> Data have been shown demonstrating that acute myeloid leukemia cells are more sensitive to cryopreservation than normal hematopoietic progenitors, so that freezing of marrow could eliminate these cells,<sup>20</sup> but it is unclear whether such *in vitro* studies are relevant in ALL. Most data regarding the efficacy of purging have been gleaned from studies in patients in disease states beyond first remission, in those individuals thought to be at high risk of first relapse, and in pediatric patients.<sup>16,17,21-26</sup> In most instances, investigators have used immunologic methods, eg, monoclonal antibodies, to purge the bone marrow, because it is usually possible to identify antigens on the surface of the leukemia cells to use as targets with antibodies. Because it is thought that agents such as 4-hydroperoxycyclophosphamide (4-HC) have significantly less activity against lymphoblasts than against myeloblasts,<sup>27,28</sup> experience with chemical purging in ALL is more limited. However, the results of autoBMT in ALL in those studies using purged marrow are comparable to those reported for the reinfusion of unpurged bone marrow, in which a 48% 3-year disease-free survival was described.<sup>29</sup> The benefit of *in vitro* purging, therefore, remains unclear and has not been demonstrated to enhance outcome.<sup>19</sup> Furthermore, there are no studies to demonstrate what contribution, if any, infused occult malignant ALL cells present in autologous marrow or peripheral blood make to relapse. At present, a prospective randomized international study conducted jointly by the Eastern Cooperative Oncology Group (ECOG) in the United States and the Medical Research Council (MRC) of the UK is evaluating the role of unpurged autologous bone marrow or peripheral stem cell transplantation in ALL patients in first remission.

## RESULTS OF AutoBMT

The results of several series using autoBMT in ALL in first complete remission are summarized in Table 1. In general, these studies involved small numbers of patients, many of whom were children. Leukemia-free survival rates range from 25%–60% at 3 years after transplant.<sup>30</sup> Interesting surveys published by the European Group for Blood and Marrow Transplantation (EBMT) allude to the increasing use of this modality and provide an idea of its effectiveness.<sup>36,38</sup> These surveys reported leukemia-free survival rates of ~40% in patients with standard risk as well as in patients with high-risk. In some cases, the follow-up was >6 years. Despite a large sample size, this type of survey data has limited value, and meaningful conclusions and comparisons regarding the relative merits of autotransplants are limited. Additionally, retrospective analyses from multiple centers represent selected patients and often do not define precisely the timing of the transplant, making it even more difficult to accurately assess the efficacy of this therapeutic modality. Thus, any information about the superiority, or otherwise, of autologous transplants compared with conventional chemotherapy cannot be inferred from these studies.

On the other hand, Fiére et al.<sup>32</sup> reported on the only completed and published prospective randomized study. This multicenter French study compared 3 postremission therapies. Patients <40 years of age with a histocompatible sibling were assigned to allogeneic transplantation. Patients without an HLA-matched sibling

**Table 1.** Autologous Bone Marrow Transplantation for Acute Lymphoid Leukemia in First Remission\*

Author	Year	Reference	Number of Patients	Median Age, y (Range)	3-y Disease-Free Survival, %
Blaise et al.	1990	30	22	31 (7–47)	40
Kantarjian et al.	1990	31	26	30	60
Carey et al.	1991	29	15	30 (18–51)	57
Fiére et al.	1993	32	63	NS	39†
Vey et al.	1994	33	34	29 (16–59)	27‡
Powles et al.	1995	34	50	26 (15–58)	53
Attal et al.	1995	35	64	NS	29
EBMT	1995	36	834	30 (18–51)	42‡
Fiére et al.	1998	37	63	NS	34§

\*Data represent updated reports (several of these publications represent cohorts of patients previously described). EBMT, European Group for Blood and Marrow Transplantation; NS, not stated. Table modified from Rowe.<sup>42</sup> †At 5 years; ‡at 8 years; §at 10 years.

and those between ages 40 and 50 years were randomized to autologous transplantation vs. conventional maintenance therapy. The 3-year disease-free survival rate was not significantly better for autologous bone marrow transplantation (39%) vs. chemotherapy (32%).<sup>32</sup> The validity of these data has been emphasized by a long-term analysis and the publication of the 8- to 10-year follow-up<sup>37,39</sup> in which these earlier data were confirmed, suggesting that autologous transplantation may be at least as effective as conventional protracted maintenance therapy and that about one third of patients can probably be cured with a single course of autologous transplantation without subsequent maintenance (Table 2). However, although this trial demonstrated that autologous transplants appear to be at least as good as conventional maintenance therapy for adult ALL patients in first complete remission, some confusion remains. First, the actual number of patients who received an autotransplant is relatively small (63), especially when subgroup analysis of high-risk vs. low-risk ALL is attempted. Second, those patients who were randomized to receive autologous transplantation vs. chemotherapy received 3 courses of intensive consolidation before autologous transplantation. Thus, it is not easy to extrapolate data for true early autologous transplantation in ALL in first remission. Nevertheless, this trial is important, and these data were the first suggestions from a prospective study that autologous transplantation may be at least as good as conventional protracted maintenance therapy

The issue of peripheral blood stem cell transplantation is fairly novel in ALL but is becoming increasingly used without any apparent attempt to obtain definitive comparative data. However, it seems that engraftment occurs at about the same rate as after mobilized peripheral blood stem cell transplants in ALL, and the published early data on hematopoietic engraftment from the Royal Marsden Hospital, London, UK, suggest that there is a significant improvement in the time to neutrophil and platelet recovery (Table 3).<sup>34</sup> Unfortunately, in comparing peripheral blood stem cell with bone marrow transplants, one is not always comparing identical hematopoietic effects; the emerging data on peripheral blood

**Table 2.** Randomized Study of Bone Marrow Transplantation (BMT) in First Complete Remission (CR): Long-Term Confirmation of Early Data From the French Group on Therapy of Adult Acute Lymphoblastic Leukemia

<i>Post-CR (Intent-to-Treat)</i>	<i>Allogeneic BMT</i>	<i>Autologous BMT</i>	<i>Chemotherapy</i>
<i>n</i>	116	95	191
Disease-free survival, %			
Fiére et al., 1993 <sup>33</sup>	43	39	32
Fiére et al., 1998 <sup>34</sup>	46	34	30
High risk	44	11	16
Standard risk	49	49	39

**Table 3.** Significant Improvement in Neutrophil and Platelet Recovery Following Peripheral Blood Stem Cell Transplant (PBSCT) in Acute Lymphoblastic Leukemia\*

	<i>Autologous BMT</i>	<i>PBSCT</i>	<i>P</i>
Days to neutrophils $\geq 500/\mu\text{L}$	27.5 (15–57)	15.5 (12–27)	<.0001
Days to platelets $>50,000/\mu\text{L}$	39 (19–97)	17 (12–77)	<.0002

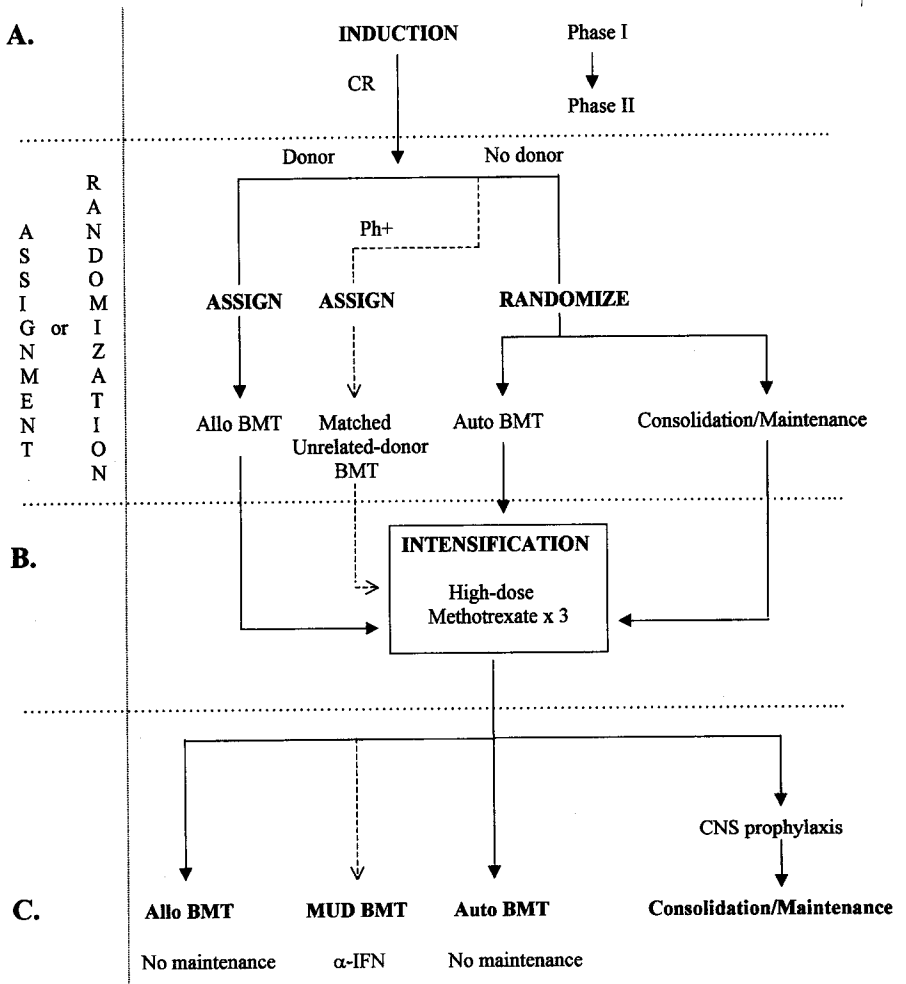
\*Data are median (range). Adapted from Powles *et al.*<sup>34</sup>

stem cell transplants are almost invariably following mobilization with chemotherapy and cytokines, whereas the historical data on bone marrow transplantation are, in most cases, devoid of any stimulation by cytokines or chemotherapy. Thus, any differences may be related more to the effects of mobilization than to any specific and anatomic compartments.

## THE FUTURE

A major ongoing study is underway that may provide important information in this regard. The International ALL Study Group represents a transatlantic effort between ECOG in the United States and MRC in Britain. This is a prospective study comparing the role of allogeneic transplantation for patients who have a matched histocompatible sibling and all other patients, who are randomized to receive either conventional chemotherapy or an autologous transplant (Figure 1). Whereas different risk groups have been identified in adult ALL, and many of the conventional protocols attempt to adapt therapy to each risk group, this study stratifies the patients only by risk groups, but maintains the study randomization for all such patients. The only exception is for patients with very-high-risk factors such as the presence of Ph, which may also be diagnosed by the presence of the *abc/abl* oncogene (even in the absence of the 9;22 translocation using standard cytogenetics). A search for a matched unrelated donor is recommended for these patients in preference to standard chemotherapy or autologous transplantation.

In this prospective randomized study, all patients receive identical induction and intensification therapies. A direct prospective comparison may then be made between allogeneic transplantation, autologous transplantation using identical preparative regimens (fractionated total body irradiation [TBI] and high-dose VP-16), and conventional maintenance therapy. The overall study design is conceptually very similar to the recently completed US AML intergroup study.<sup>40</sup> All treatment strategies are decided before intensification to allow for an intent-to-treat analysis and the avoidance of selection and other biases. Patients undergo induction with a standard regimen; those who achieve complete remission are placed into a decision tree. Furthermore, timing of transplants is rigorously defined



**Figure 1.** Study design of the International ALL Study Group. ALL, acute lymphoblastic leukemia; BMT, bone marrow transplantation; CNS, central nervous system; CR, complete remission; IFN, interferon; MUD, matched unrelated donor; Ph, Philadelphia chromosome.

to allow for reliable comparisons. Those who have a histocompatible sibling donor are assigned to allogeneic transplant, including patients in standard risk. Those who do not have a compatible sibling donor are randomized between autologous BMT and conventional consolidation/maintenance therapy.

Following this allocation to specific treatment arms, all patients receive the same intensification therapy with 3 courses of high-dose methotrexate. After this, patients go on to receive their assigned arm: allogeneic, autologous, or matched-

unrelated donor transplant or conventional chemotherapy. All patients are stratified by age, white blood cell count at presentation, time to complete remission, immunophenotype, karyotype (performed by conventional methods as well as molecular analysis), and the presence of central nervous system involvement at diagnosis. The rationale behind the study is to see whether the differences in therapy apply among all the groups, some of the groups, or none of the groups. The importance of this study is the large number of patients accruing in an effort to obtain meaningful data. The study is ongoing, and to date >1050 patients have been registered. As with all transplant studies, there is a significant drop-off in patients getting their assigned or randomized treatment.<sup>41</sup> This study will thus remain open for another year or so until the target of 325 randomized patients is achieved.

Such prospective collaborative efforts are critical to the understanding of the best therapy for adult ALL in first remission and are likely to influence treatment strategies over the next decade. Gene marking studies, as performed in AML, may assist in confirming whether reinfused leukemic cells contribute to relapse but will not answer the question as to whether purging will reduce relapse.

### SUMMARY

Over the past decade, attempts have been made to define the role, if any, of autologous transplantation in patients with ALL. One major randomized study suggests that such a form of therapy may be at least as good as conventional therapy, and a current large international effort is under way to more clearly define the role of this form of therapy for ALL patients in first remission.

### REFERENCES

1. Hoelzer D, Thiel E, Loeffler H, et al. Prognostic factors in a multi-center study for treatment of acute lymphoblastic leukemia in adults. *Blood* 71:123–131, 1988.
2. Gaynor J, Chapman D, Little C, et al. A cause-specific hazard rate analysis of prognostic factors among 199 adults with acute lymphoblastic leukemia: the Memorial Hospital experience since 1969. *J Clin Oncol* 6:1014–1030, 1988.
3. Hussein KK, Dahlberg S, Head D, et al. Treatment of acute lymphoblastic leukemia in adults with intensive induction consolidation and maintenance chemotherapy. *Blood* 73:57–63, 1989.
4. Blacklock HA, Matthews JR, Buchanan JG, et al. Improved survival for acute lymphoblastic leukemia in adolescents and adults. *Cancer* 48:1931–1935, 1981.
5. Schauer P, Arlin ZA, Mertelsmann R, et al. Treatment of acute lymphoblastic leukemia in adults: results of the L-10M protocols. *J Clin Oncol* 1:462–470, 1983.
6. Sanchez-Fayos J, Outeirino J, Villalobos E, et al. Acute lymphoblastic leukemia in adults: results of a “total-therapy” programme in 47 patients over 15 years old. *Br J Haematol* 59:689–696, 1985.

7. Marcus RE, Catovsky D, Johnson SA, et al. Adult acute lymphoblastic leukemia: study of prognostic features and response to treatment over a ten-year period. *Br J Haematol* 53:175–180, 1986.
8. Hoelzer D, Gale RP. Acute lymphoblastic leukemia in adults: recent progress, future directions. *Semin Hematol* 24:27–39, 1987.
9. Hoelzer D. Acute lymphoblastic leukemia: progress in children, less in adults. *N Engl J Med* 329:1343–1344, 1993.
10. Secker-Walker LM, Craig JM, Hawkins JM, et al. Philadelphia-positive acute lymphoblastic leukemia in adults: age, distribution, bcr breakpoint and prognostic significance. *Leukemia* 5:196–199, 1991.
11. Maurer J, Janssen JWG, Theil E, et al. Detection of chimeric BCR-ABL genes in acute lymphoblastic leukemia by the polymerase chain reaction. *Lancet* 337:1055–1058, 1991.
12. Westbrook CA, Hooberman AL, Spino C, et al. Clinical significance of the BCR-ABL fusion gene in adult acute lymphoblastic leukemia: a Cancer and Leukemia Group B Study (8762). *Blood* 80:2983–2990, 1992.
13. Hoelzer D. Treatment of acute lymphoblastic leukemia. *Semin Hematol* 31:1–15, 1994.
14. Sierra J, Radich J, Hansen JA, et al. Marrow transplants from unrelated donors for treatment of Philadelphia-chromosome-positive acute lymphoblastic leukemia. *Blood* 90:1410–1415, 1997.
15. Aversa F, Tabilio A, Velardi A, et al. Transplantation of high-risk acute leukemia with T-cell-depleted stem cells from related donor with one fully mismatched I-ILA haplotype. *N Engl J Med* 339:1186–1193, 1998.
16. Kersey JH, Weisdorf D, Nesbit ME, et al. Comparison of autologous and allogeneic bone marrow transplantation for treatment of high-risk refractory acute lymphoblastic leukemia. *N Engl J Med* 317:461–467, 1987.
17. Ramsay NKC, Kersey JH. Indications for marrow transplantation in acute lymphoblastic leukemia. *Blood* 75:815–818, 1990.
18. Gorin NC. Autologous bone marrow transplantation in hematologic malignancies. *Am J Clin Oncol* 14 (Suppl 1):5, 1991.
19. Lazarus HM, Rowe JM, Goldstone AH. Does *in vitro* bone marrow purging improve the outcome after autologous bone marrow transplantations? *J Hematother* 2:457–466, 1993.
20. Allieri MA, Lopez M, Douay L, et al. Clonogenic leukemia progenitor cells in acute myelocytic leukemia are highly sensitive to cryopreservation: possible purging effect for autologous bone marrow transplantation. *Bone Marrow Transplant* 7:101–105, 1991.
21. Sallan FE, Niemeyer CM, Billett A, et al. Autologous bone marrow transplantation for acute lymphoblastic leukemia. *J Clin Oncol* 7:1594–1601, 1989.
22. Simonsson B, Burnett AK, Prentice HG, et al. Autologous bone marrow transplantation with monoclonal antibody purged marrow for high risk acute lymphoblastic leukemia. *Leukemia* 3:631–636, 1989.
23. Ramsay N, LeBien T, Weisdorf D, et al. Autologous BMT for patients with acute lymphoblastic leukemia. In: Gale R, Champlin R, eds. *Bone Marrow Transplantation: Current Controversies*. New York, NY: Alan Liss, 1989, p. 57–67.
24. Gilmore MAE, Hamon MD, Prentice HG, et al. Failure of purged autologous bone marrow transplantation in high-risk acute lymphoblastic leukaemia in first complete remis-

- sion. *Bone Marrow Transplant* 8:19–26, 1991.
25. Atta J, Fauth F, Keyser M, et al. Purging in BCR-ABL-positive acute lymphoblastic leukemia using immunomagnetic beads: comparison of residual leukemia and purging efficiency in bone marrow versus peripheral blood stem cells by semiquantitative polymerase chain reaction. *Bone Marrow Transplant* 25:97–104, 2000.
  26. Billett AL, Kornmehl E, Tarbell NJ, et al. Autologous bone marrow transplantation after a long first remission for children with recurrent acute lymphoblastic leukemia. *Blood* 81:1651–1657, 1993.
  27. Santos GW, Saral R, Bums WH, et al. Allogeneic, syngeneic and autologous marrow transplantation in acute leukemias and lymphomas: Baltimore experiences. *Acta Hematol (Basel)* 78 (Suppl 1):175–180, 1987.
  28. Uckun FM, Gajl-Peczalska K, Meyers DE, et al. Marrow purging in autologous marrow transplantation for T-lineage ALL: efficacy of *ex vivo* treatment with immunotoxins and 4-hydroperoxycyclophosphamide against fresh leukemic marrow progenitor cells. *Blood* 69:361–366, 1987.
  29. Carey PJ, Proctor SJ, Taylor P, et al. Autologous bone marrow transplantation for high-grade lymphoid malignancy using melphalan-irradiation conditioning without marrow purging or cryopreservation. *Blood* 77:1593–1598, 1991.
  30. Blaise D, Gaspard MH, Stoppa AM, et al. Allogeneic or autologous bone marrow transplantation for acute lymphoblastic leukemia in first complete remission. *Bone Marrow Transplant* 5:7–12, 1990.
  31. Kantarjian HM, Walters RS, Keating MJ, et al. Results of the vincristine, doxorubicin, and dexamethasone regimen in adults with standard- and high-risk acute lymphocytic leukemia. *J Clin Oncol* 8:994–1004, 1990.
  32. Fiére D, Lepage E, Sebban C, et al. Adult acute lymphoblastic leukemia: a multicentric randomized trial testing bone marrow transplantation as post-remission therapy. *J Clin Oncol* 11:1990–2001, 1993.
  33. Vey N, Blaise D, Stoppa AM, et al. Bone marrow transplantation in 63 adult patients with acute lymphoblastic leukemia in first complete remission. *Bone Marrow Transplant* 14:383–388, 1994.
  34. Powles R, Mehta J, Singhal S, et al. Autologous bone marrow or peripheral blood stem cell transplantation followed by maintenance chemotherapy for adult acute lymphoblastic leukemia in first remission: 50 cases from a single center. *Bone Marrow Transplant* 16:241–247, 1995.
  35. Attal M, Blaise D, Marit G, et al. Consolidation treatment of adult acute lymphoblastic leukemia: a prospective randomized trial comparing allogeneic versus autologous bone marrow transplantation in testing the impact of recombinant interleukin-2 after autologous bone marrow transplantation. *Blood* 86:1619–1628, 1995.
  36. European Bone Marrow Transplant Group (EBMTG): Working party on acute leukemia. Annual Report, 1995.
  37. Fiére D, Sebban C, Reiffers J. Comparison of allogeneic transplantation, autologous transplantation and chemotherapy as post induction treatment in adult acute lymphoblastic (ALL): long-term report of the French Group of Treatment of Adult ALL (LALA 87 protocol) [abstract]. *Proc Am Soc Clin Oncol* 17:54a, 1998.



38. Labopin M, Gorin NC. Autologous bone marrow transplantation in 2505 patients with acute leukemia in Europe: a retrospective study. *Leukemia* 6 (Suppl 4):95–99, 1992.
39. Thiebaut A, Vernant JP, Degos L, et al. Adult acute lymphocytic leukemia study testing chemotherapy and autologous and allogeneic transplantation: a follow-up report of the French protocol LALA 87. *Hematol Oncol Clin North Am* 14:1353–1356, 2000.
40. Cassileth PA, Harrington D, Appelbaum FR, et al. A comparison of chemotherapy versus autologous bone marrow transplantation versus allogeneic bone marrow transplantation in first remission of adult acute myeloid leukemia: an intergroup study (E3489). *N Engl J Med* 339:1649–1656, 1998.
41. Berman E, Little C, Gee T, et al. Reason that patients with acute myelogenous leukemia did not undergo allogeneic bone marrow transplantation. *N Engl J Med* 326:156–160, 1992.
42. Rowe JM. Bone marrow transplantation for acute lymphoblastic leukemia (ALL) in first complete remission. In: Dicke KA, Keating A, eds. *Autologous Blood and Marrow Transplantation: Proceedings of the Ninth International Symposium*. Charlottesville, VA: Carden Jennings Publishing, 1999, p. 57.

# Hematopoietic Stem Cell Transplantation as Treatment for Philadelphia Chromosome–Positive Acute Lymphoblastic Leukemia

**J. Sierra, L. Muñoz, M. Rovira, C. Canals, J.J. Ortega, T. Olivé,  
I. Badell, A. Julià, E. Carreras, S. Brunet, J.M. Ribera, E. Montserrat**

*Hematology and Pediatrics Departments (J.S., L.M., C.C., I.B., S.B.), Hospital de la Santa Creu i Sant Pau; Hospital Germans Trias i Pujol (J.M.R.); Hospital General i Materno-Infantil Vall d'Hebrón (J.J.O., T.O., A.J.); Institut de Malalties Hematològiques i Oncològiques (M.R., E.C., E.M.), Barcelona, Spain*

## ABSTRACT

Between 1991 and 1998, 22 patients with Philadelphia chromosome (Ph)-positive acute lymphoblastic leukemia (ALL) (mean age, 28 years; range, 6–54 years) received a stem cell transplantation (SCT) in Barcelona. Patients had been initially treated with standard induction therapy for high-risk ALL. Following consolidation, the patients received autologous or allogeneic stem cell transplantation (autoSCT or alloSCT), depending on the availability of a suitable related or unrelated HLA-matched donor. In the 8 patients of the autoSCT group, the bone marrow was *ex vivo* purged. Seven of these patients were in first complete remission (CR), and 1 was in first relapse. Fourteen patients received an alloSCT, 13 of them from related donors (12 HLA-identical and 1 one-antigen mismatched) and 1 patient from an HLA-matched unrelated donor. Source of cells for alloSCT was bone marrow ( $n = 4$ ), peripheral blood ( $n = 9$ ), or umbilical cord blood ( $n = 1$ ). Seven allografted patients were in first CR, 3 in second CR, 2 in first or second relapse, and 1 patient was resistant to chemotherapy. Conditioning regimen was total body irradiation (TBI) and cyclophosphamide (CY) in 13 patients, TBI, CY, and VP-16 (etoposide) in 5, and other combinations in 4. Graft-vs.-host disease (GVHD) prophylaxis consisted of cyclosporine (CSP) plus prednisone ( $n = 4$ ), CSP plus methotrexate ( $n = 8$ ), CSP plus T-cell depletion ( $n = 1$ ), or CSP alone ( $n = 1$ ).

Although no transplant-related mortality was observed among patients treated with autoSCT, all of them relapsed and subsequently died. After a median follow-up of 76 months, the actuarial survival at 3 years in first CR patients was  $30\% \pm 15\%$ . The prognosis after allografts in more advanced stages of ALL was dismal.

This study indicates that autoSCT is not a good option for Ph<sup>+</sup> ALL patients and confirms that alloSCT performed in first CR may be curative for a minority of patients.

## INTRODUCTION

The Philadelphia chromosome is detectable in ~30% of adults and 2%–5% of children with ALL.<sup>1</sup> This chromosome abnormality consists of a reciprocal translocation of most of the *c-abl* protooncogene in the long arm of chromosome 9 and the breakpoint cluster region (*bcr*) gene in the long arm of chromosome 22: t(9;22)(q34;q11).

The probability of achieving CR with chemotherapy in Ph<sup>+</sup> ALL is ~70%. Unfortunately, almost all patients treated with chemotherapy alone develop a leukemia relapse, and therefore, long-term leukemia-free survival (LFS) is <15%.<sup>1</sup> Data from single institutions and from the International Bone Marrow Transplant Registry (IBMTR) indicate that allogeneic marrow transplant from related donors may provide long-term LFS for a substantial number of patients with Ph<sup>+</sup> ALL.<sup>2–5</sup> The development of a registry network including almost 6 million HLA-typed volunteers has extended the availability of allogeneic transplantation to patients without a family match. The results of marrow transplants from unrelated donors in this setting have been recently published, showing encouraging results.<sup>6</sup>

This report summarizes the experience of 4 hospitals from Barcelona on hematopoietic SCT for patients with Ph<sup>+</sup> ALL. The findings in this study confirm that allotransplants in first CR are a curative option for some patients.

## MATERIALS AND METHODS

Between 1991 and 1998, 22 patients with Ph<sup>+</sup> ALL (mean age, 28 years; range, 6–54 years) received an SCT in Barcelona. The main clinical and biological characteristics appear in Table 1. This series included 3 (14%) children <18 years of age. Fourteen (64%) of the 22 patients were transplanted in first CR.

Patients had been initially treated with standard induction therapy for high-risk ALL. Following consolidation, the patients received autoSCT or alloSCT, depending on the availability of a suitable related or unrelated HLA-matched donor (Table 2). Seven of the 8 patients of the autoSCT group were autografted with bone marrow *ex vivo* purged with monoclonal antibodies and complement or immunomagnetic beads. Seven of these patients were in first CR and 1 was in first relapse. Fourteen patients received an alloSCT, 13 of them from related donors (12 HLA-identical and 1 one-antigen mismatched) and 1 from an HLA-matched unrelated donor. Source of cells for alloSCT was bone marrow ( $n = 4$ ), peripheral blood ( $n = 9$ ), or umbilical cord blood ( $n = 1$ ). Seven allografted patients were in first CR, 3 in second CR, 3 in first or second relapse, and 1 patient was resistant to

**Table 1.** Clinical and Biological Characteristics of the Patients\*

Patient	Sex	Age, y	Immuno-phenotype	WBC at Diagnosis ( $\times 10^9/L$ )	Karyotype	Disease Status at SCT	Type of SCT
1	M	23	CALLA <sup>+</sup>	5	46 XY, t(4;15), t(9;22)(q34q11)	CR1	Auto
2	F	44	CALLA <sup>+</sup>	9	46 XX, t(9;22)(q34q11)	CR1	Auto
3	M	33	CALLA <sup>+</sup>	31	45 XY, t(9;22)(q34q11)12p+,-20	CR1	Auto
4	F	33	CALLA <sup>+</sup>	14.6	46 XX, t(9;22)(q34q11)	CR1	Auto
5	M	39	Pro-B	14.3	46 XY, t(9;22)(q34q11)+ t(9;22)(q34q11)	CR1	Auto
6	F	43	CALLA <sup>+</sup>	13	46 XX, t(9;22)(q34q11)	CR1	Auto
7	F	27	CALLA <sup>+</sup>	650	46 XX, t(9;22)(q34q11)	CR1	Auto
8	M	23	Pre-B	4.6	46 XY, t(9;22)(q34q11)	First relapse	Auto
9	M	21	Pro-B	8	46 XY/44 XY, -7,t(9;22)(q34 q11)-13,(12q;q13q)	CR1	Allo
10	F	27	Pro-B	161	46 XX, t(9;22)(q34q11)	CR1	Allo
11	F	21	CALLA <sup>+</sup>	1.6	46 XX, t(9;22)(q34q11)	CR1	Allo
12	F	15	Pre-B	14.3	46 XX, t(9;22)(q34q11)	CR1	Allo
13	F	48	CALLA <sup>+</sup>	31	46 XX, t(9;22)(q34q11)+7	CR1	Allo
14	M	2	CALLA <sup>+</sup>	3.6	46 XY, t(9;22)(q34q11),11q-	CR1	Allo
15	M	20	Pro-B	14.6	46 XY t(9;22)(q34q11)/56 XXY +2,+3,+6,+8,+9,-11,+13,+14	CR1	Allo
16	M	27	CALLA <sup>+</sup>	84	46 XY, t(9;22)(q34q11)	First early relapse	Allo
17	M	10	CALLA <sup>+</sup>	15.8	46 XY, t(9;22)(q34q11)/hyperdiploidy 56 XY	First relapse	Allo
18	F	54	CALLA <sup>+</sup>	43	46 XX, t(9;22)(q34q11)	CR2	Allo
19	F	23	CALLA <sup>+</sup>	1.6	46 XX/46 XX, t(1;7;11)(p11;p11;p11),-4,-7,9p+, t(9;22)(q34q11)	CR2	Allo
20	F	6	CALLA <sup>+</sup>	5.1	46 XX, t(9;22)(q34q11)	CR2	Allo
21	F	42	Biphenotypic	7.7	46 XX, t(9;22)(q34q11)	Second relapse	Allo
22	M	19	CALLA <sup>+</sup>	161	46 XY, t(9;22)(q34q11),del9	Refractory	Allo

\*Allo, allogeneic stem cell transplant; Auto, autologous bone marrow transplant; CR, complete remission; WBC, white blood cell count.

**Table 2.** Characteristics of the Transplant Groups and Outcome\*

	<i>Autologous BMT</i>	<i>Allogeneic SCT</i>
<i>n</i>	8	14
Median age, y (range)	30 (10–48)	27 (7–55)
Sex, M/F	4/4	6/8
Disease status at transplant		
CR1	7	7
CR2	0	3
Relapse	1	4
Source of stem cells		
Bone marrow	8	4
Peripheral blood	0	9
Cord blood	0	1
Acute GVHD II–IV	0	4
Chronic GVHD	0	1
Nonleukemic death	0	8
Relapse	8	4

\**BMT, bone marrow transplantation; CR, complete remission; GVHD, graft-vs.-host disease; SCT, stem cell transplantation.*

chemotherapy. Conditioning regimen was TBI and CY in 13 patients, TBI, CY, and VP-16 in 5, and other combinations in 4. GVHD prophylaxis consisted of CSP plus prednisone ( $n = 4$ ), CSP plus methotrexate ( $n = 8$ ), CSP plus T-cell depletion ( $n = 1$ ), or CSP alone ( $n = 1$ ).

## RESULTS

### Autologous Transplants

All 8 patients engrafted. Median time to achieve a neutrophil count  $>0.5 \times 10^9/L$  was 26 days (range, 12–52 days). A self-sustained platelet count superior to  $20 \times 10^9/L$  was reached after a median of 55 days (range, 11–180 days).

The results of the procedure are summarized in Table 2. No patient experienced transplant-related death. Leukemia recurrence after autoSCT developed in all cases, and the patients died due to disease progression shortly thereafter.

### Allogeneic Transplants

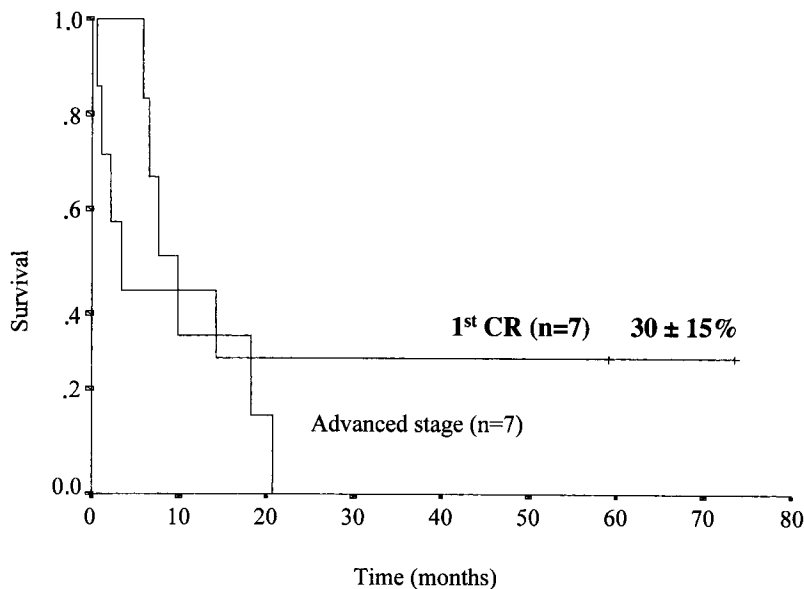
Median time to achieve a neutrophil count  $>0.5 \times 10^9/L$  was 16 days (range, 11–21 days). A self-sustained platelet count  $>20 \times 10^9/L$  was reached

after a median of 12 days (range, 8–21 days). No case of primary graft failure was observed.

As shown in Table 2, 4 patients (29%) developed grades II–IV acute GVHD, and 1 patient at risk suffered from chronic GVHD. Transplant-related mortality was high, occurring in 8 patients; in 4 instances in the first month after transplant and in 4 between months 2 and 6 after the procedure. Only 2 patients allografted in first CR were long-term leukemia-free survivors. After a median follow-up of 76 months, the actuarial survival at 3 years in patients receiving an allogeneic transplant in first CR was  $30\% \pm 15\%$  (Figure 1).

## DISCUSSION

The Philadelphia chromosome confers poor prognosis to children and adult ALL. They frequently achieve a first CR but almost invariably develop a leukemic relapse. Median CR duration in Ph<sup>+</sup> ALL is 6–8 months.<sup>1</sup> Because of this poor outcome after chemotherapy alone, allogeneic marrow transplantation has been recommended for patients with Ph<sup>+</sup> ALL with an HLA-identical sibling. IBMTR data show that such approach is associated with a 31% LFS at 2 years for all patients and a 38% LFS for patients in first CR.<sup>4</sup> A review of the data on 47 patients

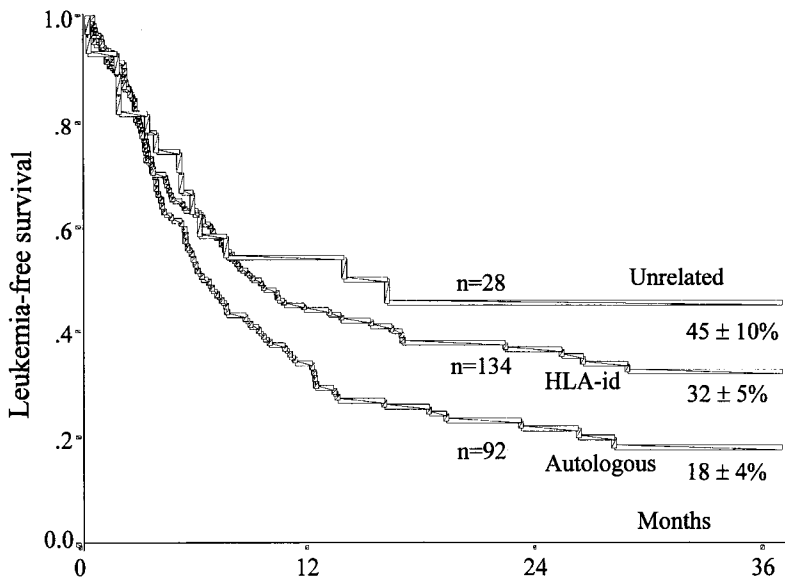


**Figure 1.** Survival after allogeneic stem cell transplantation for Philadelphia chromosome-positive acute lymphoblastic leukemia in Barcelona (1991–1998). CR, complete remission.

reported from 9 centers show similar results with 33% LFS.<sup>2,3,7-9</sup> Recently, the outcome of 326 children with Ph<sup>+</sup> ALL has been reviewed.<sup>10</sup> Of the 267 patients who reached a CR, 147 were subsequently treated with chemotherapy, and 120 received an SCT. Thirty-eight patients were transplanted from a matched related donor; 9 of them relapsed, 3 died due to complications of the procedure, and 26 remained alive in remission. LFS at 5 years in this group of 38 children was 65%  $\pm$  8%, significantly better than after chemotherapy alone.

Patients without a HLA-compatible family donor are frequently offered an unrelated donor transplant or an autologous transplant. The data published to date show that 24 of 35 patients (69%) with Ph<sup>+</sup> ALL included in 6 studies relapsed or died in remission after auto-SCT.<sup>3,5,7,8,9,11</sup>

Our series confirms that allogeneic SCT is an option for early-stage Ph<sup>+</sup> ALL. A recent analysis of the European Group for Blood and Marrow Transplantation (M. Labopin, personal communication) in adult patients in first CR agrees with this finding (Figure 2). Of note, SCT from unrelated donors appears to be an alternative for patients who lack a family match. The results from the EBMT in this setting are similar to those recently reported by the Seattle group.<sup>6</sup> For a timely identification of an unrelated donor in patients with Ph<sup>+</sup> acute leukemia, HLA typing should be



**Figure 2.** Leukemia-free survival after allogeneic stem cell transplantation in adult patients with Philadelphia chromosome-positive acute lymphoblastic leukemia in first complete remission. Data of the European Blood and Marrow Transplant Group (M. Labopin, personal communication). id, identical.

studied at diagnosis and in absence of a compatible relative, the donor search should be initiated shortly after.

Transplant-related mortality was high in our series. Transplant early in the course of the disease, before multiple cycles of chemotherapy are administered, may decrease patient morbidity and improve outcome. Relapses were also frequent; for this reason posttransplant administration of interleukin-2, interferon, or cellular immunotherapy needs to be investigated. Additionally, since recent studies have emphasized the usefulness of *bcr-abl* PCR monitoring for the prediction of leukemia recurrence in patients with Ph<sup>+</sup> ALL,<sup>12</sup> a close follow-up of minimal residual disease after transplant seems mandatory.

### ACKNOWLEDGMENTS

The authors thank Myriam Labopin, from the Acute Leukemia Working Party of the EBMT, for the data which are included in the discussion section.

### REFERENCES

1. Hoelzer D. Treatment of acute lymphoblastic leukemia. *Semin Hematol* 31:1–15, 1994.
2. Forman SJ, O'Donell MR, Nademanee AP, et al. Bone marrow transplantation for patients with Philadelphia chromosome-positive acute lymphoblastic leukemia. *Blood* 70:587–588, 1987.
3. Miyamura K, Tanimoto M, Morishima Y, et al. Detection of Philadelphia chromosome-positive acute lymphoblastic leukemia by polymerase chain reaction: possible eradication of minimal residual disease by marrow transplantation. *Blood* 79:1366–1370, 1992.
4. Barret AJ, Horowitz MM, Ash RC, et al. Bone marrow transplantation for Philadelphia chromosome-positive acute lymphoblastic leukemia. *Blood* 79:3067–3070, 1992.
5. Stockschröder M, Hegewisch-Becker S, Krüger W, et al. Bone marrow transplantation for Philadelphia-chromosome-positive acute lymphoblastic leukemia. *Bone Marrow Transplant* 16:663–667, 1995.
6. Sierra J, Radich J, Hansen JA, et al. Marrow transplants from unrelated donors for treatment of Philadelphia chromosome-positive acute lymphoblastic leukemia. *Blood* 90:1410–1414, 1997.
7. Annino L, Ferrari A, Cedrone M, et al. Adult Philadelphia-chromosome-positive acute lymphoblastic leukemia: experience of treatments during a ten-year period. *Leukemia* 8:664–667, 1994.
8. Preti HA, O'Brien S, Giralt S, Beran M, Pierce S, Kantarjian HM. Philadelphia-chromosome-positive adult acute lymphocytic leukemia: characteristics, treatment results, and prognosis in 41 patients. *Am J Med* 97:60–65, 1994.
9. Brennan C, Weisdorf D, Kersey J, Haake R, Ramsay N. Bone marrow transplantation for Philadelphia chromosome-positive acute lymphoblastic leukemia. *Proc Am Soc Clin Oncol* 10:222a, 1991.
10. Aricó M, Valsecchi MG, Camitta B, et al. Outcome of treatment in children with



- Philadelphia chromosome-positive acute lymphoblastic leukemia. *N Engl J Med* 342: 998–1006, 2000.
11. Powles R, Mehta J, Singhal S, et al. Autologous bone marrow or peripheral blood stem cell transplantation followed by maintenance chemotherapy for adult acute lymphoblastic leukemia in first remission: 50 cases from a single center. *Bone Marrow Transplant* 16:241–247, 1995.
  12. Radich J, Gehly G, Lee A, et al. Detection of *bcr-abl* transcripts in Philadelphia chromosome-positive acute lymphoblastic leukemia after marrow transplantation. *Blood* 89:2602–2609, 1997.

# **Transplantation Therapy for Adults With Acute Lymphoblastic Leukemia: Comparative Analysis of Autologous and Unrelated Donor Bone Marrow Transplantation**

*Daniel Weisdorf, Bernie Dharan, Mary Horowitz*

*The University of Minnesota (D.W.); the Writing Committee  
of the National Marrow Donor Program (B.D.); the Autologous  
Bone Marrow Transplant Registry (M.H.)*

Recurrent or high-risk acute lymphoblastic leukemia (ALL) is best treated with bone marrow or blood stem cell transplantation. With a histocompatible sibling donor, transplantation can yield 30%–50% survival and disease-free survival (DFS) after extended follow-up.<sup>1,2</sup> For those lacking a sibling donor, however, transplantation using either autologous blood or marrow or unrelated donor (URD) marrow are available options. Autotransplantation is associated with relatively low treatment-related mortality but a higher risk of relapse.<sup>3–5</sup> In contrast, allogeneic URD transplantation must be delayed until a suitable donor is identified<sup>6</sup> and yields higher rates of complications, including graft failure, graft-vs.-host disease (GVHD), and prolonged immunodeficiency with later posttransplant infections.<sup>7–9</sup> However, URD transplantation has a powerful allogeneic antileukemic effect and a lower risk of posttransplant recurrence. The comparative value of these 2 approaches in patients with ALL has been studied only infrequently.<sup>8,9</sup> The analysis reported herein compares autotransplantation and URD allotransplantation in adults with ALL. Treatment-related mortality, engraftment, relapse, and survival outcomes are described.

## **PATIENTS AND METHODS**

Two patient data sets were used for this analysis; the first included URD transplants facilitated through the National Marrow Donor Program (NMDP), and the second, autotransplants with data reported to the Autologous Blood and Marrow Transplantation Registry (ABMTR). Analyses were restricted to adults aged >18 years who received transplantation in first complete remission (CR1) or CR2 before December 31, 1998. Minimum follow-up was 1 year. The individual data sets were compiled and verified through the multicenter data collection and

audit processes of the NMDP and ABMTR, respectively. Comparative analysis of auto- and allotransplants used the  $\chi^2$  statistic to assess differences between groups. Outcomes were estimated using the Kaplan-Meier or cumulative incidence methods, and comparisons used the log-rank test. Cox proportional hazards regression was used for multivariate analysis.

URD transplants included 246 adults and were compared with 80 autotransplant recipients. The autologous transplant recipients were slightly older, with a median age of 32 years (range, 19–51 years) vs. 28 years (range, 19–51 years) for the URD recipients ( $P=.05$ ). Sixty-four percent of the autologous and 57% of the URD cohorts were male. More autologous patients were in CR1 (64% vs. 48%;  $P=.009$ ), and accordingly, their time from diagnosis to transplant was shorter: a median of 8 months vs. 12 months for URD transplants ( $P=.005$ ). More patients with high-risk ALL, manifested by adverse cytogenetic subsets, were present in the URD group, as only 10% of autologous and 28% of URD transplants had a high-risk karyotype [t(9;22), t(4;11), or t(8;14)] ( $P=.002$ ). Autotransplants occurred earlier: 75% between 1989 and 1995 vs. 41% of URD transplants ( $P=.001$ ). Fewer autografts used total body irradiation (TBI), 52% vs. 91% ( $P=.001$ ).

## ENGRAFTMENT

Neutrophil recovery was slower after autotransplants than after URD allografting, especially after purged autotransplants. By day 28, in both CR1 and CR2 patients, neutrophil recovery was significantly more likely after URD transplantation (CR1, 93%  $\pm$  3% vs. autologous 51%  $\pm$  13%,  $P<.0001$ ; CR2, 89%  $\pm$  4% vs. autologous 73%  $\pm$  16%,  $P=.06$ ). By day 100, however, nearly all patients had hematopoietic recovery, and the differences were no longer significant. Multivariate analysis suggested slower engraftment after purged autografts and in CR1 patients coming to transplant  $\leq$ 6 months from diagnosis. Additionally, transplantation using TBI and transplantation during 1989–1995 (vs. 1995–1998) were independently associated with significantly slower engraftment. There were no effects of other variables examined.

## TREATMENT-RELATED MORTALITY

As expected, treatment-related mortality (defined as death in continuous complete remission) was significantly more frequent after URD compared with autotransplantation. One hundred twenty-one of 246 (49%) URD vs. 11 of 89 (12%) autologous transplant recipients died of complications relating to transplantation ( $P=.001$ ). Multivariate analysis showed significantly higher transplanted-related mortality after URD transplantation from either matched or partially matched donors and in older patients. Surprisingly, patients with normal cytoge-

netics also had a higher risk of transplant-related mortality vs. those with abnormal cytogenetics or those with unknown cytogenetics. There was no effect of sex, performance status, time to transplantation ( $\leq 6$  months from diagnosis), time to initial CR1, or duration of CR1.

### LEUKEMIA RELAPSE

Protection against leukemia recurrence was substantially greater after URD vs. autotransplantation. After transplantation in CR1, only 17% of URD vs. 43% of autologous recipients relapsed ( $P=.0006$ ). Similarly, for CR2, 23% of URD vs. 80% of autograft recipients relapsed. Multivariate analysis confirmed significantly increased risk of relapse in autotransplant and a trend to increased relapse in purged autotransplant as well as in CR2 patients. Additionally, a diagnostic white blood cell count (WBC)  $>50 \times 10^9/L$  was associated with an increased risk of posttransplant relapse. There was no effect of age, sex, duration of CR1, T- vs. B-lineage ALL, cytogenetics, or prior extramedullary leukemia.

### SURVIVAL

At 3 years following transplantation, survival for patients transplanted in CR1 was 40% with URD vs. 48% with autotransplantation ( $P=.19$ ). Results were not as good in CR2, with 27% of URD and 14% of autologous transplant recipients surviving ( $P=.87$ ). Partially matched URD transplant recipients had significantly lower probability of survival than matched URD or autologous transplant recipients. Patient age, sex, performance status, T- vs. B-lineage ALL, time to CR1, and duration of CR1 had no significant impact on survival.

### DISEASE-FREE SURVIVAL

After 3 years, URD and autotransplant recipients had similar DFS. URD transplants yielded 36% and autotransplants 46% DFS for patients transplanted in CR1; probabilities were 26% and 10% in CR2. Multivariate analysis demonstrated significantly poorer DFS in patients undergoing partially matched URD transplants, transplants performed in CR2, and patients with a diagnostic WBC  $>50 \times 10^9/L$ . No independent effect of age, sex, performance status, immunophenotypic lineage, time to CR1, duration of CR1, or cytogenetics was observed.

### DISCUSSION

These results provide no definitive message about the comparative superiority of URD or autologous bone marrow transplantation (BMT) for adults with ALL,

although partially matched URD transplants and purged autotransplants were techniques resulting in somewhat poorer outcomes. In CR1, matched URD and unpurged autologous BMT resulted in similar survival and DFS. In CR2, the better protection against relapse with URD BMT might suggest superior survival and DFS, although this finding was not validated in multivariate regression analysis.

A previous analysis of similar data compared URD transplantation with purged autografts from the University of Minnesota and the Dana-Farber Cancer Institute.<sup>9</sup> In that report, DFS was superior for children, men, and BMT performed during CR1 or CR2 compared with more advanced disease or older patients. In both regression analysis and recursive partition analysis, however, only a trend could suggest the advantage of URD vs. autotransplantation, and that was apparent only in patients <18 years old. Both techniques yielded ~25% survival in adults. An expert panel decision analysis offered no clear consensus about the best choice of transplant options.<sup>10</sup>

The major barrier to capitalizing on the powerful antileukemic effect of URD transplantation is the substantial treatment-related mortality. Despite better matching and improved donor selection, nearly half of adult patients undergoing URD transplantation for ALL die of transplant-associated complications, and only one third of those transplanted in CR1 and one quarter of those in CR2 survive disease free. Improved prevention of both acute and chronic GVHD and correction of the continuing immunodeficiency resulting in an increased risk of late infection will be required to advance the outcomes of URD transplants for adult ALL. In contrast, however, the disappointing and persistent high rates of relapse after autografting limit its suitability to only selected patients with few or no allogeneic transplant options. Improved conditioning regimens or posttransplant antileukemic therapies will be required to improve the outcome of patients in CR2. Additional study will be needed to determine which subsets of patients having a defined mix of risk features will be best served by one or the other of these 2 transplant choices.

## REFERENCES

1. Oh H, Gale RP, Zhang MJ, et al. Chemotherapy vs. HLA-identical sibling bone marrow transplants for adults with acute lymphoblastic leukemia in first remission. *Bone Marrow Transplant* 22:253–257, 1998.
2. Zhang M-J, Hoelzer D, Horowitz M, et al. Long-term follow-up of adults with acute lymphoblastic leukemia in first remission treated with chemotherapy or bone marrow transplantation. *Ann Intern Med* 123:428–431, 1995.
3. Weisdorf DJ. Autologous hematopoietic stem cell transplantation for acute lymphoblastic leukemia. In: Atkinson K, ed. *Clinical Bone Marrow Transplantation*. Cambridge, UK: Cambridge University Press, 2000, p. 267–274.
4. Simonsson B, Burnett AK, Prentice HG, et al. Autologous bone marrow transplantation with monoclonal antibody purged marrow for high risk acute lymphoblastic leukemia.

*Leukemia* 3:631–636, 1989.

5. Granena A, Castellsague X, Badell I, et al. Autologous bone marrow transplantation for high risk acute lymphoblastic leukemia: clinical relevance of *ex vivo* bone marrow purging with monoclonal antibodies and complement. *Bone Marrow Transplant* 24:621–626, 1999.
6. Davies SM, Ramsay NKC, Weisdorf DJ. Feasibility and timing of unrelated donor identification for patients with ALL. *Bone Marrow Transplant* 17:737–740, 1996.
7. Davies SM, Shu XO, Blazar BR, et al. Unrelated donor bone marrow transplantation: influence of HLA A and B incompatibility on outcome. *Blood* 86:1636–1642, 1995.
8. Busca A, Anasetti C, Anderson G, et al. Unrelated donor or autologous marrow transplantation for treatment of acute leukemia. *Blood* 83:3077–3084, 1994.
9. Weisdorf DJ, Billett AL, Hannan P, et al. Autologous versus unrelated donor allogeneic marrow transplantation for acute lymphoblastic leukemia. *Blood* 90:2962–2968, 1997.
10. Gale RP, Park RE, Dubois RW, et al. Delphi-panel analysis of appropriateness of high-dose therapy and bone marrow transplants in adults with acute lymphoblastic leukemia in first remission. *Leuk Res* 22:973–981, 1998.

# **CHAPTER 9**

## **CML**





# **Autografting With or Without Mobilized Hematopoietic Progenitor Cells in Chronic Myeloid Leukemia**

**Angelo Michele Carella, Maria Teresa Corsetti,  
Enrica Lerma, Marina Cavaliere**

*Department of Haematology, Hematology/ASCT Unit,  
Ospedale San Martino, Genoa, Italy*

## **ABSTRACT**

Chronic myeloid leukemia (CML) is a clonal myeloproliferative disease of transformed, primitive hematopoietic stem cells. CML was the first leukemia in which the abnormal growth-promoting signal called p210<sup>bcr-abl</sup> oncoprotein was discovered. Recent studies have further defined the molecular events involved in its initiation and progression (Federl S, et al. *N Engl J Med* 341:164–172, 1999). Although effective treatments have been developed for CML, the majority of patients still die of their disease because they are not eligible for transplantation or do not respond to interferon (IFN). Allografting is the only curative procedure in CML, and for patients without HLA-compatible donors, current therapeutic options include conventional chemotherapy (hydroxyurea), IFN- $\alpha$ , and autografting. Although IFN- $\alpha$  ( $\pm$  low-dose cytosine arabinoside [LD Ara-C]) is considered to be first-line therapy, autografting may allow us to develop a sequential treatment strategy in the management of CML patients. The genetically normal hematopoietic reservoir declines with time in CML, so it may be desirable to mobilize and collect these stem cells at diagnosis.

## **INTRODUCTION**

CML is a neoplastic disorder originating in a primitive hematopoietic stem cell. The main characteristic of this mutation is the formation of a fusion gene (BCR-ABL) with abnormal tyrosine kinase activity, leading to abnormal hematopoiesis. Clinically, CML is characterized by an initial chronic phase (CP) followed by inevitable progression to an accelerated and then terminal blastic phase. Allografting is currently the only curative treatment, but the majority of CML patients do not have HLA-matched sibling donors. Unrelated donor transplants are

associated with high transplant-related mortality within the first 100 days following the procedure and can be offered only to patients under 40 years of age.

For older patients or those without compatible donors, therapy for CML includes hydroxyurea (HU), IFN- $\alpha$ , and probably tyrosine kinase inhibitors. HU does not modify the natural history of the disease. Randomized studies with IFN- $\alpha$  indicate that it can induce more cytogenetic remissions and prolong overall survival.<sup>1-4</sup> Unfortunately, most IFN- $\alpha$  responders maintain molecular evidence of BCR/ABL expression, indicating that IFN- $\alpha$  is unlikely to cure CML. Recently, IFN- $\alpha$  combined with (LD Ara-C) has resulted in an improved cytogenetic remission rate and overall survival compared with IFN- $\alpha$  alone.<sup>5</sup> We have yet to evaluate whether the high cost of IFN- $\alpha$  ( $\pm$  LD Ara-C or HU), the incidence of side effects in about 25%–30% of patients, and the low rate of long-term benefit outweigh the small increase in overall survival.

Autologous stem cell transplantation has been explored as an option for the treatment of these patients. In this article, we focus on recent advances with this procedure, particularly on *in vivo* manipulation techniques. Tyrosine kinase inhibitors appear to be effective therapeutically and in inducing cytogenetic remission and are currently being studied in various trials.<sup>6</sup>

## RATIONALE FOR AUTOGRAFTING IN CML

There are at least 2 reasons for autografting in CML to improve overall survival. Long-term culture–initiating cells (LTC-ICs) from CML patients have a poor self-maintenance capacity<sup>7</sup>; therefore, reducing both normal and leukemic stem cell numbers should give normal hematopoietic stem cells a proliferative advantage. The normal hematopoietic reservoir declines with time in CML; therefore, one should mobilize and collect Philadelphia chromosome (Ph)-negative progenitors as soon after diagnosis as possible.<sup>8</sup> These observations have been confirmed after treatment with IFN- $\alpha$ ,<sup>3,4,8-11</sup> intensive chemotherapy,<sup>12-15</sup> and mobilization of Ph<sup>-</sup> progenitor cells after intensive chemotherapy.<sup>16-24</sup> Cytogenetic and other clonality studies suggest but do not prove that these cells are “normal” hematopoietic progenitors.<sup>25-29</sup> To obtain normal progenitor cells, *in vitro* and *in vivo* approaches have been evaluated.

### In Vitro Manipulations

The Vancouver group demonstrated in a series of elegant experiments that Ph<sup>+</sup> cell numbers declined when put in culture, whereas previously unidentifiable Ph<sup>-</sup> cells emerged with preferential survival rates.<sup>6,7,30,31</sup> The physiological reason for this is unclear; some of the emerging Ph<sup>-</sup> cells show features of very primitive hematopoietic cells. On the basis of these findings, the Vancouver group devised a

trial consisting of a 10-day culture of CML bone marrow and subsequent infusion into chemotherapy-conditioned patients previously selected on the basis of the ability of their bone marrow to produce an adequate number of normal LTC-ICs in vitro. Over a 5-year period, the group evaluated 87 patients and selected 36 for the 10-day marrow culture, of whom 22 have been autografted. Sixteen patients remained alive up to 68 months postautograft, and 5 remain in complete or partial cytogenetic remission.<sup>32</sup> This technique is technically demanding and not feasible for most transplant units.

The Minneapolis group has shown that CD34<sup>+</sup>DR<sup>-</sup> cells are predominantly or exclusively Ph<sup>-</sup>; in contrast, CD34<sup>+</sup>DR<sup>+</sup> cells are Ph<sup>+</sup>. It has been reported recently that in patients in early chronic phase, CD34<sup>+</sup>DR<sup>-</sup> cells are negative for BCR-ABL mRNA in 80% of cases.<sup>33</sup> Large-scale selection with a high-speed fluorescence activated cell sorting with a marrow harvest of 2–2.5 L, results in 1 to 3×10<sup>5</sup>/kg CD34<sup>+</sup>DR<sup>-</sup> cells. The frequency of colony-forming cells (CFCs) and LTC-ICs ranged from 2.6% to 8.6% and 0.187% to 0.233%, respectively. Both CD34<sup>+</sup>DR<sup>-</sup> cells and secondary CFCs were negative for BCR-ABL mRNA. Therefore, this large-scale selection of CD34<sup>+</sup>DR<sup>-</sup> cells allows a highly purified autograft and may represent a step in the development of curative therapeutic strategies.

Other approaches include purging Ph<sup>+</sup> marrow cells with interferon<sup>34,35</sup> or incubating marrow with antisense oligodeoxynucleotides directed at the BCR-ABL junctional sequences<sup>36,37</sup> or the upstream sequences of MYB.<sup>38,39</sup> In a study conducted jointly by the Hammersmith Hospital (London) and the University of Pennsylvania (Philadelphia), autologous bone marrow cells have been collected from CML patients and subjected to an in vitro purging procedure using a 24-mer phosphorothioate antisense oligomer directed against codons 2–7 of the human MYB gene.<sup>39</sup> Twelve patients have been recruited to this study, and 4 have been rendered entirely or predominantly Ph<sup>-</sup> at the 3-month postautograft assessment. This Ph negativity has been transient in all cases.<sup>38,39</sup>

Another purging concept is to employ an agent that would preferentially protect normal progenitors from the effects of chemotherapy. Macrophage inflammatory protein (MIP)-1 $\alpha$  is a candidate molecule that inhibits normal but not CML progenitors and may have clinical potential as a protective agent during chemotherapy or for chemotherapeutic purging of CML autografts.<sup>40</sup> Another novel approach involves incubation of marrow cells with ribozymes,<sup>41–43</sup> catalytic RNA species that can be tailored to recognize and disrupt leukemia-specific mRNA molecules.

### In Vivo Manipulations

The Genoa team has now treated a large number of patients either resistant to IFN- $\alpha$  or previously untreated with intensive chemotherapy (idarubicin, Ara-C, and etoposide [VP-16]); ifosfamide, carboplatin, and etoposide (ICE); or mini-ICE followed by

administration of granulocyte colony-stimulating factor (G-CSF).<sup>16,17,44-46</sup> In most cases, it was possible to collect predominantly or exclusively Ph<sup>-</sup> myeloid progenitor cells. There is preliminary evidence that the Ph<sup>-</sup> progenitor cells were easier to collect in patients who had not received IFN- $\alpha$ .

The Swedish study adopted a different approach to *in vivo* purging.<sup>47</sup> CML patients were subjected to therapy of increasing intensity, with the aim of achieving Ph negativity in the bone marrow. Once Ph negativity was achieved, patients proceeded to bone marrow harvest which, despite interferon treatment, was successful. A total of 194 patients have been recruited to this study; only 4% of the 118 patients who have received IFN- $\alpha$  and hydroxyurea for 6 months became Ph<sup>-</sup>, but increasing numbers became Ph<sup>-</sup> following successive cycles of chemotherapy. Overall, 47 patients (18% of total) achieved Ph negativity, of whom 31 have been autografted with Ph<sup>-</sup> bone marrow. Of these 31 patients, 15 remain completely Ph<sup>-</sup> 35-65 months posttransplant. Sixty-eight percent of all patients in the study survive at 6 years. A proportion of patients entered into the study have been allografted, which may modified the survival data. Unfortunately, no further update of these data has been published since 1994.<sup>47</sup>

### CLINICAL RESULTS WITH *IN VIVO* TECHNIQUE EMPLOYED IN GENOA

One hundred eighty-seven patients with Ph<sup>+</sup> CML in different phases of the disease entered the Genoa protocol (Table 1). Thirty-eight patients were mobilized in blast phase, 28 patients in accelerated phase, and 121 patients in chronic phase. Fifty-five patients in early chronic phase were entered within a year of diagnosis and had not received IFN- $\alpha$ ; another 66 patients received prior IFN- $\alpha$  therapy and were cytogenetically unresponsive.

The treatment regimen for mobilization, ICE, consisted of idarubicin 8 mg/m<sup>2</sup> per day on day 1-5, Ara-C 800 mg/m<sup>2</sup> by 2-h infusion on days 1-5, and etoposide

**Table 1.** Clinical Characteristics\*

Number of patients	187
Median age, y (range)	47 (21-62)
Phase of disease	
Blastic phase	38
Accelerated phase	28
Chronic phase	66
Early chronic phase	55
Mobilization regimens	ICE, mini-ICE
Toxicity (>grade 2)	36 (22)
Procedure-related deaths	8 (5)

\*Data are n or n (%) unless noted otherwise. ICE, ifosfamide, carboplatin, and etoposide.

**Table 2.** Clinical Characteristics of Patients in Early Chronic Phase\*

Number of patients	55
Median age, y (range)	48 (21–62)
Sex, M/F	44/11
Median WBC at diagnosis (range)	100 (13–550)
Sokal index	
Low	23 (42)
Intermediate	19 (34)
High	13 (24)
Median time from diagnosis to mobilization, mo (range)	2 (1–12)
Mobilization regimen	
ICE	17
Mini-ICE	38

\*Data are n or n (%) unless note otherwise. ICE, ifosfamide, carboplatin, and etoposide; WBC, white blood cell count.

150 mg/m<sup>2</sup> per day by 2-h infusion on days 1–3. The data from patients pretreated with IFN- $\alpha$  have been updated,<sup>11</sup> but in this article, we focus on patients in early phase disease not previously treated with IFN- $\alpha$  (Table 2). Seventeen patients received ICE, and 38 patients, mini-ICE. In all cases, G-CSF was given at 5  $\mu$ g/kg from day 8 after chemotherapy. Leukapheresis was started when the white blood cell count exceeded  $0.8\text{--}1\times 10^9/\text{L}$  and  $>10$  CD34<sup>+</sup>cells/ $\mu\text{L}$  were present in the peripheral blood. Daily apheresis was performed until the total CD34<sup>+</sup> cells collected were  $2\times 10^6/\text{kg}$ . All patients completed the mobilization protocol, with no procedure-related deaths. Toxicity consisted of alopecia, mild mucositis, and diarrhea, mainly in patients treated with the ICE protocol (Table 3). In 5 patients, oral mucositis grade 3 (World Health Organization [WHO]) and diarrhea occurred. In contrast, only a few patients treated with mini-ICE experienced oral mucositis and diarrhea ( $\leq$ grade 2, WHO). Cytogenetic analysis of collected peripheral blood

**Table 3.** Toxicity after High-Dose Therapy in 33 Patients Autografted in Early Chronic Phase of CML\*

Grade	CNS	Renal	Hepatic	Stomatitis	GI
3	0	0	0	17 (52)	3 (9)
2	0	1 (3)	4 (12)	7 (21)	3 (9)
1	0	1 (3)	3 (9)	3 (9)	1 (3)
Total with any degree of toxicity	0	2 (6)	7 (21)	7 (21)	7 (21)

\*Data are n (%). CML, chronic myeloid leukemia; CNS, central nervous system; GI, gastrointestinal.

**Table 4.** Results\*

<i>Cytogenetic Response (% Ph<sup>+</sup>)</i>	<i>Response on Peripheral Blood Progenitor Cells</i>
Complete (0)	33 (60)
Major (1–34)	11 (20)
Minor (35–94)	7 (13)
None (>95)	4 (7)

\*Data are n (%). Ph, Philadelphia chromosome.

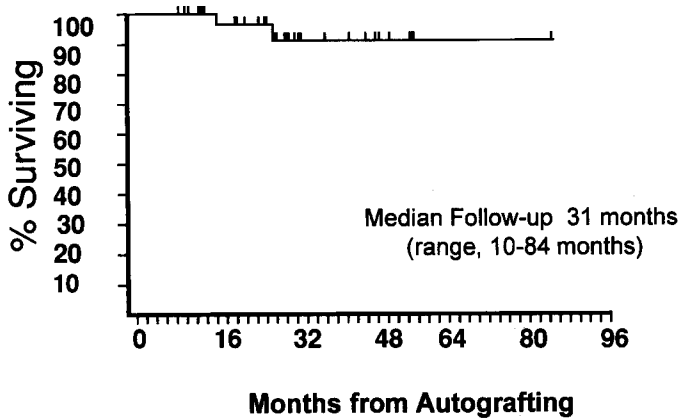
progenitor cells (PBPCs) showed Ph<sup>-</sup> cells in 33 patients (60%) and <34% Ph<sup>+</sup> cells in 11 patients (20%) (major cytogenetic remission [MCyR]). Forty-four of the 55 patients (ICE, 14 of 17; mini-ICE, 30 of 38) therefore had Ph<sup>-</sup> or MCyR harvests (Table 4). In comparison, patients pretreated with IFN- $\alpha$  in late chronic phase had a lower rate of complete cytogenetic remission. These results were supported by the significantly greater numbers of CD34<sup>+</sup> cells, colony-forming units-granulocyte/macrophage (CFU-GM), and LTC-ICs in the newly diagnosed patients.

In the last 2 years, minimal residual disease monitoring has been carried out in PBPC collections using quantitative competitive reverse transcription–polymerase chain reaction (QC RT-PCR) for BCR-ABL. Thirty-one consecutive patients have been analyzed, 18 in early disease phase. This study shows that multiple stem cell collections from the same patients contained different numbers of leukemic cells and

**Table 5.** Clinical Characteristics of Patients Autografted in Early Chronic Phase\*

Median age, y (range)	47 (22–62)
Sex, M/F	26/7
Previous therapy (hydroxyurea)	33
Median time from diagnosis to mobilization, mo (range)	2 (1–12)
Mobilizing therapy	
ICE	11
Mini-ICE	22
Cytogenetics on peripheral blood progenitor cells	
Ph <sup>-</sup>	24
Ph <sup>+</sup> <34%	7
Ph <sup>-</sup> >34%	2
Median CD34 <sup>+</sup> cell dose, $\times 10^6$ /kg (range)	4.04 (1.06–74.5)
Median CFU-GM cell dose, $\times 10^4$ /kg (range)	19.2 (0.11–108.25)
High-dose therapy	
TBI-containing	6
Busulfan	27

\*CFU-GM, colony-forming unit-granulocyte/macrophage; ICE, ifosfamide, carboplatin, and etoposide; TBI, total body irradiation.



33 pts, 91 % (95% CL: 66-98)

**Figure 1.** Autografting results in early chronic phase patients.

that several patients had an adequate number of progenitors for autografting in the least contaminated collections.<sup>48</sup> Indeed, by comparing Ph<sup>-</sup> collections of patients in the early phase of the disease with the corresponding Ph<sup>-</sup> collections of the other group of patients, BCR-ABL mRNA is lower in the earlier group of mobilized patients.<sup>48</sup>

To date, 33 patients have been autografted (Ph<sup>-</sup>, 24; MCyR, 7; Ph<sup>+</sup>, 2). High-dose therapy consisted of busulfan (4 mg/kg per day  $\times$  4 days) in 27 patients and total body irradiation (TBI)-containing regimens (idarubicin, etoposide, and single-dose TBI) in 6 patients (Table 4). All patients engrafted, with no toxic deaths (Table 5). After hematopoietic recovery, all patients were treated with low-dose IL-2, 2 million units daily for 5 days every 9 weeks, and IFN- $\alpha$  3 million units daily for 8 weeks; after 1 week off therapy, the cycle was repeated a total of 3 times. Patients were then maintained with IFN- $\alpha$  alone. The median follow-up from autografting is 31 months (range, 10–84 months) (Figure 1). Two patients developed blast crisis at 18 and 29 months after autografting and died of leukemia. The remaining 28 patients are in hematologic remission, with 17 in complete (9 patients) or major (8 patients) cytogenetic remission, 10–56 months after autografting.

In conclusion, premobilization chemotherapy provided preferential *in vivo* reduction of the Ph<sup>+</sup> stem cell population and, with G-CSF, stimulated the release of primitive Ph<sup>-</sup> hematopoietic stem cells into the blood. A prospective randomized study to compare IFN- $\alpha$   $\pm$  Ara-C vs. autograft followed by IFN- $\alpha$   $\pm$  Ara-C in patients with newly diagnosed CML is ongoing (MRC/ECOG/EBMT, CML 2000).

## SUMMARY

Residual normal hematopoiesis is present at diagnosis in some patients with CML in chronic phase, leukemic cells are chemosensitive, and genetic markers exist whereby leukemia cells can be identified and quantitated. We know that it is possible to mobilize normal PBPCs in other hematologic diseases with cytogenetic markers such as Ph<sup>+</sup> acute lymphoblastic leukemia and myelodysplastic syndrome,<sup>49,50</sup> and based on the Genoa results, this approach is worth pursuing over the next few years. From a therapeutic point of view, allografting remains the treatment of choice in patients younger than 55 years with an HLA-identical sibling and for younger patients with a matched unrelated donor. The normal hematopoietic reservoir declines with time in CML, therefore it may be desirable to mobilize and collect PBSCs to store Ph<sup>-</sup> or predominantly Ph<sup>-</sup> stem cells as soon after diagnosis as possible. After 6 to 8 months, if no donor is found, the patient can be autografted with the previously stored Ph<sup>-</sup> progenitors followed by IFN- $\alpha$  therapy. Tyrosine kinase inhibitors administered either alone or to purge patients in vivo may provide an exciting new approach to treating patients with CML.

## REFERENCES

1. Allan NC, Richards SM, Shepherd PCA. UK Medical Research Council randomised multicentre trial of interferon-alpha n1 for chronic myeloid leukemia: improved survival irrespective of cytogenetic response. *Lancet* 345:1392-1397, 1995.
2. Hehlmann R, Heimpel H, Hasford J, et al. Randomized comparison of interferon-alpha with busulfan and hydroxyurea in chronic myelogenous leukemia (CML). *Blood* 84: 4064-4077, 1994.
3. Talpaz M, Kantarjian H, Kurzrock R, Trujillo JM, Gutterman JU. Interferon-alpha produces sustained cytogenetic responses in chronic myelogenous leukemia. *Ann Intern Med* 114:532-538, 1991.
4. ICSCML (The Italian Cooperative Study Group on Chronic Myeloid Leukemia). Interferon alfa-2a as compared with conventional chemotherapy for the treatment of chronic myeloid leukemia. *N Engl J Med* 330:820-825, 1994.
5. Guilhot F, Chastang C, Michallet M, et al. Interferon alfa-2b combined with cytarabine versus interferon alone in chronic myelogenous leukemia. French Chronic Myeloid Leukemia Study Group. *N Engl J Med* 337:223-229, 1997.
6. Druker BJ, Talpaz M, Resta D. Clinical efficacy and safety of an ABL specific tyrosine kinase inhibitor as targeted therapy for CML. *Blood* 94 (Suppl. 1):1639, 1999.
7. Udomsakdi C, Eaves CJ, Swolin B, Reid DS, Barnett MJ, Eaves AC. Rapid decline of chronic myeloid leukemic cells in long-term culture due to a defect at the leukemic stem cell level. *Proc Natl Acad Sci U S A* 89:6192-6196, 1992.
8. Udomsakdi C, Eaves CJ, Lansdorp PM, Eaves AC. Phenotypic heterogeneity of primitive leukemic hematopoietic cells in patients with chronic myeloid leukemia. *Blood* 80: 2522-2530, 1992.



9. Ozer H, George SL, Schiffer CA, et al. Prolonged subcutaneous administration of recombinant alpha 2b interferon in patients with previously untreated Philadelphia chromosome-positive chronic-phase chronic myelogenous leukemia: effect on remission duration and survival: Cancer and Leukemia Group B study 8583. *Blood* 82:2975–2984, 1993.
10. Gordon MY, Goldman JM. Cellular and molecular mechanisms in chronic myelogenous leukaemia: biology and therapy. *Br J Haematol* 95:10–17, 1996.
11. Carella AM, Cunningham I, Lerma E, et al. Mobilization and transplantation of Philadelphia-negative peripheral blood progenitor cells early in chronic myelogenous leukemia. *J Clin Oncol* 15:1575–1582, 1997.
12. Smaller RV, Vogel J, Huguley CM Jr, Miller D. Chronic granulocytic leukemia: cytogenetic conversion of the bone marrow with cycle-specific chemotherapy. *Blood* 50:107–113, 1977.
13. Cunningham I, Gee T, Dowling M, et al. Results of treatment of Ph-positive chronic myelogenous leukemia with an intensive treatment regimen (L-5 protocol). *Blood* 53:375–384, 1979.
14. Sharp JC, Joyner MV, Wayne AW, et al. Karyotypic conversion in Ph1-positive chronic myeloid leukaemia with combination chemotherapy. *Lancet* i:1370–1372, 1979.
15. Goto T, Nishikori M, Arlin Z, et al. Growth characteristics of leukemic and normal hematopoietic cells in Ph-positive chronic myelogenous leukemia and effects of intensive treatment. *Blood* 59:793–808, 1982.
16. Carella AM, Gaozza E, Raffo MR, et al. Therapy of acute phase chronic myelogenous leukemia with intensive chemotherapy, blood cell autotransplant and cyclosporine A. *Leukemia* 5:517–521, 1991.
17. Carella AM, Podestà M, Frassoni F, et al. Collection of “normal” blood repopulating cells during early hemopoietic recovery after intensive conventional chemotherapy in chronic myelogenous leukemia. *Bone Marrow Transplant* 12:267–271, 1993.
18. Kantarjian HM, Talpaz M, Hester J, et al. Collection of peripheral blood diploid cells from chronic myelogenous leukemia patients early in the recovery phase from myelosuppression induced by intensive-dose chemotherapy. *J Clin Oncol* 13:553–559, 1995.
19. Kirk JA, Reems JA, Roecklein BA, et al. Benign marrow progenitors are enriched in the CD34<sup>+</sup>/HLA-DR<sup>lo</sup> population but not the CD34<sup>+</sup>/CD38<sup>lo</sup> population of chronic myeloid leukemia: an analysis using interphase fluorescence in situ hybridization. *Blood* 86:737–743, 1995.
20. Chalmers EA, Franklin IM, Kelsey SM, et al. Treatment of chronic myeloid leukaemia in first chronic phase with idarubicin and cytarabine: mobilization of Philadelphia-negative peripheral blood stem cells. *Br J Haematol* 96:627–634, 1997.
21. Heinzing M, Waller CF, Rosenstiel A, Scheid S, Burger KJ, Lange W. Quality of IL-3 and G-CSF-mobilized peripheral blood stem cells in patients with early chronic phase CML. *Leukemia* 12:333–339, 1998.
22. Fischer T, Neubauer A, Mohm J, et al. Chemotherapy-induced mobilization of karyotypically normal PBSC for autografting in CML. *Bone Marrow Transplant* 21:1029–1036, 1998.
23. Janssen JJWM, van Rijn RS, van der Holt B, et al. Mobilization of haemopoietic progenitors in CML: a second course of intensive chemotherapy does not improve Ph-nega-

- tivity in stem cell harvests. *Bone Marrow Transplant* 25:1147–1155, 2000.
24. Sureda A, Petit J, Brunet S. Mini-ICE regimen as mobilization therapy for chronic myelogenous leukemia patients at diagnosis. *Bone Marrow Transplant* 24:1285–1290, 1999.
  25. Lisker R, Casas L, Mutchinick O, Perez-Chavez F, Labardini J. Late-appearing Philadelphia chromosome in two patients with chronic myelogenous leukemia. *Blood* 56:812–814, 1980.
  26. Fialkow PJ, Martin PJ, Najfeld V, Penfold GK, Jacobson RJ, Hansen JA. Evidence for a multistep pathogenesis of chronic myelogenous leukemia. *Blood* 58:158–163, 1981.
  27. Ferraris AM, Canepa L, Melani C, Miglino M, Broccia G, Gaetani GF. Clonal B lymphocytes lack bcr rearrangement in Ph-positive chronic myelogenous leukaemia. *Br J Haematol* 73:48–50, 1989.
  28. Sessarego M, Fugazza G, Frassoni F, Defferari R, Bruzzone R, Carella AM. Cytogenetic analysis of hemopoietic peripheral blood cells collected by leukapheresis after intensive chemotherapy in advanced phase Philadelphia-positive chronic myelogenous leukemia. *Leukemia* 6:715–719, 1992.
  29. Raskind WH, Ferraris AM, Najfeld V, Jacobson RJ, Moohr JW, Fialkow PJ. Further evidence for the existence of a clonal Ph-negative stage in some cases of Ph-positive chronic myelocytic leukemia. *Leukemia* 7:1163–1167, 1993.
  30. Coulombel L, Kalousek DK, Eaves CJ, Gupta CM, Eaves AC. Long-term marrow culture reveals chromosomally normal hematopoietic progenitor cells in patients with Philadelphia chromosome-positive chronic myelogenous leukemia. *N Engl J Med* 308:1493–1498, 1983.
  31. Eaves C, Udomsakdi C, Cashman J, Barnett M, Eaves A. The biology of normal and neoplastic stem cells in CML. *Leuk Lymphoma* 11:245–253, 1993.
  32. Barnett MJ, Eaves CJ, Phillips GL, et al. Autografting with cultured marrow in chronic myeloid leukemia: results of a pilot study. *Blood* 84:724–732, 1994.
  33. Verfaillie CM, Miller WJ, Boylan K, McGlave PB. Selection of benign primitive hematopoietic progenitors in chronic myelogenous leukemia on the basis of HLA-DR antigen expression. *Blood* 79:1003–1010, 1992.
  34. McGlave PB, Arthur D, Miller WJ, Lasky L, Kersey J. Autologous transplantation for CML using marrow treated ex vivo with recombinant human interferon gamma. *Bone Marrow Transplant* 6:115–120, 1990.
  35. Becker M, Fabrega S, Belloc F, Rice A, Barbu V, Reiffers J. Interferon gamma is effective for BM purging in a patient with CML. *Bone Marrow Transplant* 12:155–158, 1993.
  36. Gewirtz AM. Treatment of CML with c-myb antisense oligodeoxynucleotides. *Bone Marrow Transplant* 14 (Suppl. 3):S57–S61, 1994.
  37. De Fabritiis P, Petti MC, Montefusco E, et al. BCR-ABL antisense oligodeoxynucleotide in vitro purging and autologous bone marrow transplantation for patients with chronic myelogenous leukemia in advanced phase. *Blood* 91:3156–3162, 1998.
  38. Luger SM, Ratajczak MZ, Stadtmauer EA. Autografting for chronic myeloid leukemia (CML) with C-MYB antisense oligodeoxynucleotide purged bone marrow: a preliminary report [abstract]. *Blood* 84 (Suppl. 1):151a, 1994.
  39. O'Brien SG, Rule SA, Ratajczak MZ. Autografting for CML using bone marrow purged with MYB antisense oligonucleotide [abstract]. *Br J Haematol* 89 (Suppl. 1):12, 1995.

40. Dunlop DJ, Wright EG, Lorimore S, et al. Demonstration of stem cell inhibition and myeloprotective effects of SCI/rh MIP-1 alpha in vivo. *Blood* 79:2221–2225, 1992.
41. Kiehltopf M, Esquivel EL, Brach MA, Herrmann F. Clinical applications of ribozymes. *Lancet* 345:1027–1031, 1995.
42. Leopold LH, Shore SK, Newkirk TA, et al. Multi-unit ribozyme-mediated cleavage of bcr-abl mRNA in myeloid leukemias. *Blood* 85:2162–2170, 1995.
43. Pachuk CJ, Yoon K, Moelling K, Coney LR. Selective cleavage of bcr-abl chimeric RNAs by a ribozyme targeted to non-contiguous sequences. *Nucleic Acids Res* 22:301–307, 1994.
44. Carella AM, Frassoni F, Melo J, Sawyers C. New insights in biology and current therapeutic options for patients with chronic myelogenous leukaemia. *Haematologica* 4: 478–495, 1997.
45. Carella AM, Lerma E, Celesti L, et al. Effective mobilization of Philadelphia-chromosome negative cells in chronic myelogenous leukaemia patients using a less intensive regimen. *Br J Haematol* 100:445–448, 1998.
46. Carella AM, Lerma E, Corsetti MT, et al. Autografting with Philadelphia-negative mobilized hematopoietic progenitor cells in chronic myelogenous leukemia. *Blood* 93: 1534–1539, 1999.
47. Simonsson B, Oberg G, Killander A, et al. Intensive treatment in order to minimize the Ph-positive clone in chronic myelogenous leukemia (CML). *Bone Marrow Transplant* 14 (Suppl. 3):S55–S56, 1994.
48. Corsetti MT, Lerma E, Dejana A, et al. Quantitative competitive reverse transcriptase-polymerase chain reaction for BCR-ABL on Philadelphia-negative leukaphereses allows the selection of low-contaminated peripheral blood progenitor cells for autografting in chronic myelogenous leukemia. *Leukemia* 13:999–1008, 1999.
49. Carella AM, Frassoni F, Pollicardo N, et al. Philadelphia-chromosome-negative peripheral blood stem cells can be mobilized in the early phase of recovery after a myelosuppressive chemotherapy in Philadelphia-chromosome-positive acute lymphoblastic leukaemia. *Br J Haematol* 89:535–538, 1995.
50. Carella AM, Dejana A, Lerma E, et al. In vivo mobilization of karyotypically normal peripheral blood progenitor cells in high-risk MDS, secondary or therapy-related acute myelogenous leukaemia. *Br J Haematol* 95:127–130, 1996.

# **ST1571: A Tyrosine Kinase Inhibitor for the Treatment of CML: Validating the Promise of Molecularly Targeted Therapy**

**Brian J. Druker**

*Division of Hematology and Medical Oncology,  
Oregon Health Sciences University, Portland, Oregon*

The Bcr-Abl fusion protein, resulting from a (9;22) chromosome translocation, causes several types of leukemia. The 210-kDa form of Bcr-Abl is present in virtually all patients with chronic myelogenous leukemia (CML), and a 185-kDa variant is present in approximately 20% of acute lymphoblastic leukemia (ALL) patients. The transforming function of Bcr-Abl requires tyrosine kinase activity of these Bcr-Abl fusion proteins, which is elevated compared with c-Abl.<sup>1</sup> Thus, Bcr-Abl is an ideal candidate for a molecularly targeted therapeutic agent, and an inhibitor of the Bcr-Abl kinase would be predicted to be an effective and selective therapeutic agent for CML.

## **DESIGNING A TYROSINE KINASE INHIBITOR**

Once an appropriate target was identified, the next task was to design an inhibitor of this enzyme. An initial lead compound was identified by scientists at Novartis, who screened a large compound library for inhibitors of protein kinases *in vitro*. In this case, the initial lead compound was a relatively weak inhibitor of protein kinase C and the platelet-derived growth factor receptor (PDGF-R).<sup>2</sup> The activity of the 2-phenylaminopyrimidine series was optimized by synthesizing a series of chemically related compounds and analyzing the relationship between structure and activity for each compound. The most potent molecules in the series were all dual inhibitors of the *v*-Abl and the PDGF-R kinases.<sup>3,4</sup> ST1571 (formerly CGP 57148B) emerged from these efforts as the lead compound for preclinical development.

## **PRECLINICAL TESTING OF ST1571**

ST1571 has been tested in a number of preclinical models, including *in vitro* assays of enzyme inhibition, cellular assays of inhibition of kinase activity and proliferation, and *in vivo* assays of tumor formation.<sup>5</sup> These studies demonstrate

that STI571 inhibits all Abl kinases at submicromolar concentrations, including p210Bcr-Abl, p185Bcr-Abl, v-Abl, and the c-Abl tyrosine kinase.<sup>6</sup> Numerous tyrosine and serine/threonine protein kinases have been tested for inhibition by STI571, and except for PDGF-R and the c-Kit tyrosine kinases, no others are inhibited.<sup>5,6</sup>

STI571, at concentrations of 1 and 10  $\mu$ M, kills or inhibits the proliferation of all Bcr-Abl-expressing cell lines tested to date.<sup>5,6</sup> In contrast, a variety of immortalized or transformed cell lines that do not express Bcr-Abl are not sensitive to STI571. In colony-forming assays using CML bone marrow or peripheral blood samples, treatment with STI571 decreased the number of colonies formed and may select for the growth of Bcr-Abl-negative progenitor cells.<sup>6,7</sup> Minimal inhibition of the colony-forming potential of normal bone marrow has been observed.<sup>6,7</sup> Thus, STI571 appears to be selectively toxic to cells expressing the constitutively active Bcr-Abl protein tyrosine kinase. Antitumor activity has been observed in syngeneic or nude mice injected with Bcr-Abl-expressing cells followed by treatment with STI571.<sup>6,8</sup>

### PHASE 1 TRIALS OF STI571

Based on the preclinical data and a lack of significant toxicity in animals, a phase 1 clinical trial was conducted in CML patients who had failed other treatment options. All patients in chronic phase ( $n = 31$ ) have achieved hematologic remissions once therapeutic dose levels were achieved. With prolonged therapy (5 months or greater), a growing fraction of these patients have cytogenetic responses, including several individuals with complete disappearance of the Philadelphia chromosome (Ph).<sup>9</sup> STI571 also has remarkable activity as a single agent in CML blast crisis and Ph<sup>+</sup> ALL patients.<sup>10</sup> Although responses tend not to be durable, 20% of myeloid blast crisis patients have ongoing responses between 6 months and 1 year. Because virtually all patients with CML express Bcr-Abl and the Bcr-Abl protein is unique to tumor cells, this disease has provided an ideal opportunity to test the concept that drugs targeted against a tumor-specific abnormality will have therapeutic utility. Ongoing studies are directed at optimizing the use of this agent, analyzing the dose-response relationships with Bcr-Abl tyrosine kinase inhibition, and analyzing the mechanisms of relapse in blast crisis patients.

### REFERENCES

1. Lugo TG, Pendergast AM, Muller AJ, Witte ON. Tyrosine kinase activity and transformation potency of bcr-abl oncogene products. *Science* 247:1079–1082, 1990.
2. Zimmermann J, Caravatti G, Mett H, et al. Phenylamino-pyrimidine (PAP) derivatives: a new class of potent and selective inhibitors of protein kinase C (PKC). *Arch Pharm*

(Weinheim) 329:371–376, 1996.

3. Buchdunger E, Zimmermann J, Mett H, et al. Inhibition of the Abl protein-tyrosine kinase in vitro and in vivo by a 2-phenylaminopyrimidine derivative. *Cancer Res* 56:100–104, 1996.
4. Buchdunger E, Zimmermann J, Mett H, et al. Selective inhibition of the platelet-derived growth factor signal transduction pathway by a protein tyrosine kinase inhibitor of the 2-phenylaminopyrimidine class. *Proc Natl Acad Sci U S A* 92:2558–2562, 1995.
5. Druker BJ, Lydon NB. Lessons learned from the development of an abl tyrosine kinase inhibitor for chronic myelogenous leukemia. *J Clin Invest* 105:3–7, 2000.
6. Druker BJ, Tamura S, Buchdunger E, et al. Effects of a selective inhibitor of the ABL tyrosine kinase on the growth of BCR-ABL positive cells. *Nat Med* 2:561–566, 1996.
7. Deininger MW, Goldman JM, Lydon N, Melo JV. The tyrosine kinase inhibitor CGP57148B selectively inhibits the growth of BCR-ABL-positive cells. *Blood* 90:3691–3698, 1997.
8. le Coutre P, Mologni L, Cleris L, et al. In vivo eradication of human BCR/ABL-positive leukemia cells with an ABL kinase inhibitor. *J Natl Cancer Inst* 91:163–168, 1999.
9. Druker BJ, Talpaz M, Resta D, et al. Clinical efficacy and safety of an Abl specific tyrosine kinase inhibitor as targeted therapy for chronic myelogenous leukemia [abstract]. *Blood* 94:368a, 1999.
10. Druker BJ, Kantarjian H, Sawyers CL, et al. Activity of an Abl specific tyrosine kinase inhibitor in patients with Bcr-Abl positive acute leukemias, including chronic myelogenous leukemia in blast crisis [abstract]. *Blood* 94:697a, 1999.

# **The Role of Megadose CD34<sup>+</sup> Cells in Haploidentical Transplantation for Leukemia: Potential Application for Tolerance Induction**

***Massimo Martelli***

*University of Perugia, Hematology Department, Perugia, Italy*

Researchers have long attempted to extend transplantation to patients without matched related donors or to those who cannot find a phenotypically identical unrelated donor in the registries. To date, even under optimal conditions (ie, Caucasian in North America and Western Europe), 40% of patients who might benefit from a bone marrow transplant (BMT) still fail to find suitable matched donors.<sup>1</sup> However, most have a family member with whom they share 1 HLA haplotype but are mismatched at the other for HLA-A, -B, -C, or -DR.

Unfortunately, until the 1990s, transplantation of bone marrow cells from a 1-haplotype mismatched related donor was largely unsuccessful in leukemia patients because of the high incidence of severe graft-vs.-host disease (GVHD) in unmanipulated transplants<sup>2</sup> and graft rejection in extensively T-cell-depleted transplants.<sup>3</sup>

Studies in animal models established that genetic barriers in allogeneic BMT could be overcome by increasing the marrow inoculum cell volume.<sup>4</sup> Adopting the principle of a stem cell megadose, which Reisner successfully pioneered in animal models, we added granulocyte colony-stimulating factor (G-CSF)-mobilized peripheral blood progenitor cells (PBPCs) to BM cells to treat 36 high-risk leukemia patients and increased the number of the CD34<sup>+</sup> cells in the inoculum to 10-fold over bone marrow alone. A primary, sustained engraftment was achieved in 80% of patients with a very rapid hematopoietic reconstitution and, although no posttransplant treatment was given to the patients, acute severe GVHD occurred in only 18% of patients, and there was no significant chronic GVHD. This pilot study showed that a high engraftment rate with reduced GVHD could be achieved in T-cell-depleted mismatched transplants by infusing a high number of extensively T-cell-depleted CD34<sup>+</sup> cells.<sup>5</sup>

We have changed our T-cell depletion procedure over the ensuing years in an attempt to optimize processing for peripheral blood cells. From October 1995 to August 1997, PBPCs were depleted of T lymphocytes by 1-step E-rosetting followed by positive selection of CD34<sup>+</sup> cells with the CellPro device; since January 1999, we have been using the CliniMACS instrument to select CD34<sup>+</sup> cells in a 1-step procedure. All these procedures yield very large numbers of CD34<sup>+</sup> cells

( $10\text{--}12 \times 10^6/\text{kg}$ ). When we started using CD34<sup>+</sup> selection, we reduced the number of T lymphocytes by 1 log ( $2\text{--}3 \times 10^4/\text{kg}$ ). Another significant change in our strategy was substituting fludarabine for cyclophosphamide in an effort to reduce the extrahematologic toxicity of our total body irradiation-based conditioning regimen. Fludarabine was given at  $40 \text{ mg}/\text{m}^2$  for 5 consecutive days. At the same time we also reduced the total lung dose of radiation from 6 to 4 Gy.

The modifications in the conditioning regimen and in graft processing did not compromise sustained primary engraftment in a series of 43 high-risk acute leukemia patients transplanted between October 1995 and August 1997.<sup>6</sup> As we had hoped, the few T cells we infused successfully prevented GVHD even without any posttransplant immunosuppressive treatment. The extrahematologic toxicity was minimal even in these advanced and heavily pretreated patients. There were no cases of veno-occlusive disease of the liver, only 15% suffered from severe oral mucositis, and 2 deaths occurred from pulmonary decompensation. To date, 9 patients survive disease free at a median follow-up of 3 years.

A reflection emerging from these results is that the highly purified CD34<sup>+</sup> cells administered in an extremely large dose may in themselves enhance engraftment. It has been recently shown in a mixed lymphocyte culture that human CD34<sup>+</sup> cells purified by the same procedure we employed in clinical transplantation specifically reduce the numbers of cytotoxic T lymphocyte precursors against their histocompatibility antigens but not against third-party stimulator cells. In other words, purified CD34<sup>+</sup> cells are able to induce specific tolerance, acting like other veto or facilitating cells.<sup>7</sup>

An analysis of the relapse rate in these high-risk leukemia patients also leads to some interesting observations. After extensive T-cell depletion, one would expect an increased risk of leukemia relapse in patients who did not develop GVHD. To date, the relapse rate in acute myeloid leukemia (AML) patients is much less than expected, considering that most patients were transplanted in refractory relapse. The low relapse rate in the AML patients could be related to potential graft-vs.-AML effector mechanisms. We have recently suggested that donor natural killer (NK)-cell alloreactivity, a biological phenomenon unique to mismatched transplants, could play a role in this antileukemia effect.<sup>8</sup> Because of the incompatibility, recipients often did not express the major histocompatibility complex (MHC) class I allele (KIR epitope) recognized by the inhibitory receptors (KIR) of all donor NK cells, and so specific donor NK clones killed recipient target cells. Under these circumstances, the transplanted stem cells regenerated host-reactive NK clones which killed pretransplant cryopreserved host lymphocytes and which could be blocked only by targets expressing the MHC class I allele missing in the recipient, but did not cause GVHD. The alloreactive clones killed 100% acute and chronic myeloid leukemia cells, suggesting that KIR epitope incompatibility in the GVH direction exerts antileukemic effects.



One major problem, at least in adults, that appears to be common to all T-cell-depleted transplants is the slow recovery of antimicrobial and antiviral responses.<sup>9</sup> However, delayed immunological reconstitution of T-cell numbers and functions is not the only risk factor leading to our 0.40 probability of infectious-related deaths. Most patients were heavily pretreated, which inevitably increases the risk of bacterial and fungal colonization before transplant. Indeed, multivariate analysis showed that a history of infections and colonization at transplant were the most significant factors for infection-related deaths (relative risk, 3.35). Interestingly, after 1 posttransplant year, no patient died of infection, because the immune system was near normal and there was no significant chronic GVHD. One of the mechanisms underlying the slow immunologic reconstitution is the T-cell depletion itself. Furthermore, there is evidence that G-CSF may play a role in delaying posttransplant reconstitution of T-cell numbers and function. G-CSF is given to donors to mobilize stem cells and to recipients to ensure engraftment. Recent studies show G-CSF promotes T helper 2 (Th2) immune deviation which, unlike Th1 responses, does not protect against intracellular pathogens and fungi.<sup>10</sup> In our 43 acute leukemia patients who received G-CSF posttransplant, the engraftment rate was 95%. However, patients exhibited a long-lasting type 2 immune reactivity, ie, Th2-inducing dendritic cells not producing interleukin (IL)-12 and high-frequencies of IL-4/IL-10-producing CD4<sup>+</sup> cells not expressing the IL-12 receptor  $\beta$ 2 chain. Similar immune reactivity patterns were observed upon exposure of donor cells to G-CSF.

Consequently, in an attempt to speed up and improve posttransplant T-cell recovery, we stopped giving G-CSF to the recipients after transplantation. At the same time, using the CliniMACS system, we significantly reduced monocyte contamination of the inoculum. Elimination of postgrafting G-CSF administration in a subsequent series of 29 acute leukemia patients, while not adversely affecting the engraftment rate, resulted in the anticipated appearance of IL-12-producing dendritic cells, CD34<sup>+</sup> cells of a mixed Th0/Th1 phenotype, and antifungal T-cell reactivity *in vitro*.<sup>11</sup> Moreover, CD4<sup>+</sup> cell counts increased significantly faster. Finally, elimination of G-CSF-mediated immune suppression did not increase the incidence of GVHD.

To conclude, our experience in mismatched transplants over the past 10 years demonstrates that engraftment can be achieved without severe GVHD and with low regimen-related toxicity and mortality. The delay in immunological reconstitution, which is inevitably associated with extensive T-cell depletion, can be shortened in part. Given the potential graft-vs.-AML effector mechanisms, which appear to be peculiar to mismatched transplants, this approach is now a clinically feasible strategy for high-risk leukemia patients.

## REFERENCES

1. Hansen JA, Petersdorf E, Martin PJ, Anasetti C. Hematopoietic stem cell transplants from unrelated donors. *Immunol Rev* 157:141–151, 1997.
2. Anasetti C, Beatty PG, Storb R, et al. Effect of HLA incompatibility on graft-versus-host disease, relapse and survival after marrow transplantation for patients with leukemia or lymphoma. *Hum Immunol* 29:79–91, 1990.
3. Kernan NA, Flomemberg N, Dupont B, O'Reilly RJ. Graft rejection in recipients of T-cell-depleted HLA-nonidentical marrow transplants for leukemia: identification of host-derived anti-donor allocytotoxic T lymphocytes. *Transplantation* 43:482–487, 1987.
4. Reisner Y, Martelli MF. Bone marrow transplantation across HLA barriers by increasing the number of transplanted cells. *Immunol Today* 16:437–440, 1995.
5. Aversa F, Tabilio A, Terenzi A, et al. Successful engraftment of T-cell-depleted haploidentical “three-loci” incompatible transplants in leukemia patients by addition of recombinant human granulocyte colony-stimulating factor-mobilized peripheral blood progenitor cells to bone marrow inoculum. *Blood* 84:3948–3955, 1994.
6. Aversa F, Tabilio A, Velardi A, et al. Treatment of high-risk acute leukemia with T-cell-depleted stem cells from related donors with one fully mismatched HLA haplotype. *N Engl J Med* 339:1186–1193, 1998.
7. Rachamin N, Gan J, Segall R, et al. Tolerance induction by “megadose” hematopoietic transplants: donor-type human CD34 stem cells induce potent specific reduction of host anti-donor cytotoxic T lymphocyte precursors in mixed lymphocyte culture. *Transplantation* 65:1386–1393, 1998.
8. Ruggeri L, Capanni M, Casucci M, et al. Role of natural killer cell alloreactivity in HLA-mismatched hematopoietic stem cell transplantation. *Blood* 94:333–339, 1999.
9. Small TN, Papadopoulos EB, Boulad F, et al. Comparison of immune reconstitution after unrelated and related T-cell-depleted bone marrow transplantation: effect of patient age and donor leukocyte infusions. *Blood* 93:467–480, 1999.
10. Pan L, Delmonte J Jr, Jaonen CK, Ferrara JL. Pretreatment of donor mice with granulocyte colony-stimulating factor polarizes donor T lymphocytes toward type-2 cytokine production and reduces severity of experimental graft-versus-host disease. *Blood* 86:4422–4429, 1995.
11. Volpi I, Perruccio K, Ruggeri L, et al. G-CSF blocks IL-12 production by antigen presenting cells: implications for improved immune reconstitution after haploidentical hematopoietic transplantation [abstract]. 41st Annual Meeting of the American Society of Hematology, New Orleans, LA, December 3–7, 1999. Abstract 2841.

# **CHAPTER 10**

## **AML**



# **Autologous Stem Cell Transplantation for Acute Myeloid Leukemia**

**Charles A. Linker, Lloyd E. Damon, Curt A. Ries, Willis Navarro,  
Arnold Rubin, Delvyn Case, Pamela Crilley, David Topolsky,  
Isadore Brodsky, Ken Zamkoff, Jeffrey L. Wolf**

*University of California, San Francisco, California; St. Joseph's Medical Center,  
Paterson, New Jersey; Maine Medical Center, Portland, Maine;  
Hahnemann University, Philadelphia, Pennsylvania; State University of  
New York, Syracuse, New York; Alta Bates Medical Center, Berkeley, California*

## **ABSTRACT**

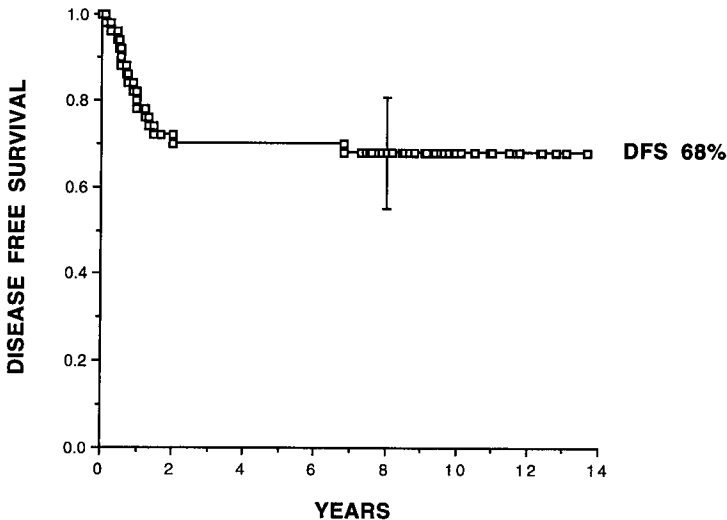
We now have long-term follow-up from our previous experience with autologous bone marrow transplantation (autoBMT) for acute myeloid leukemia (AML) using an intensive busulfan-plus-etoposide preparative regimen and bone marrow purged with 4-hydroperoxycyclophosphamide (4HC). With median follow-up of 9.5 years, 8-year disease-free survival (DFS) is 68% for patients in first remission and 52% for patients in second and third remission. Although these outcomes are encouraging, engraftment was slow, and morbidity, high. We therefore studied the feasibility and efficacy of a 2-step approach to autologous stem cell transplantation (autoSCT) for patients with AML that would improve engraftment and reduce both morbidity and resource utilization. Step 1 consisted of consolidation chemotherapy including cytosine arabinoside (Ara-C) 2000 mg/m<sup>2</sup> twice a day for 4 days concurrent with etoposide 40 mg/kg by continuous infusion over 4 days. Peripheral blood stem cells were collected during the recovery phase from this chemotherapy under granulocyte colony-stimulating factor (G-CSF) stimulation. Step 2, autologous stem cell transplantation, involved the preparative regimen of busulfan 16 mg/kg followed by etoposide 60 mg/kg (unchanged from our initial study) and reinfusion of unpurged peripheral blood stem cells. One hundred thirty-three patients were treated in first remission. During step 1, there were 2 treatment-related deaths. A median CD34<sup>+</sup> cell dose of 15×10<sup>6</sup>/kg was collected in 3 aphereses. Ten patients relapsed before transplantation, and 121 patients (91%) proceeded to transplantation. During step 2, there were 2 treatment-related deaths, and 46 patients subsequently relapsed. With median follow-up of 4.0 years, 5-year DFS for all patients entered on study is projected to be 55%. By cytogenetic risk group, 5-year DFS is 72% for favorable patients, 52% for inter-

mediate risk, and 0% for poor risk. We used the identical approach to treat 28 patients with more advanced AML, with 5-year DFS of 53%. We conclude that this 2-step approach to autologous transplantation produces excellent stem cell yields and allows a high percentage of patients to receive the intended therapy. Preliminary efficacy analysis is very encouraging, with outcomes that appear superior to those after conventional therapy

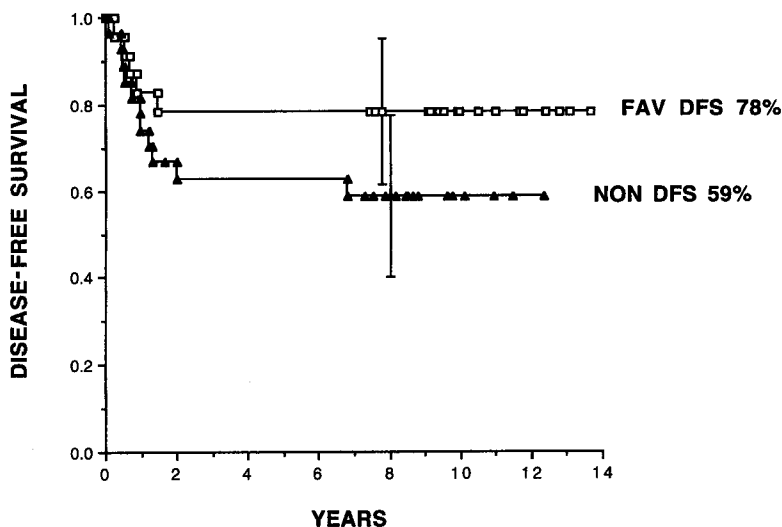
## INTRODUCTION

The optimal strategy for autologous bone marrow transplantation for AML in first remission is not well defined. Because autoBMT relies primarily on the efficacy of the preparative regimen in the absence of a graft-vs.-leukemia effect, we studied the use of an intensive regimen for autologous transplantation, combining busulfan with high-dose etoposide. Long-term follow-up of a small single-center experience using this regimen and 4HC-purged bone marrow rescue demonstrates 8-year DFS of 68% in 50 patients in first remission (Figures 1 and 2) and 52% in 25 patients in second/third remission.<sup>1-3</sup> However, although the treatment-related mortality was low (4%), delayed engraftment, prolonged hospitalization, and severe nonhematologic toxicity limited the broad application of this treatment approach.

We modified our approach to autologous transplantation to allow the more widespread use of the intensive busulfan/etoposide preparative regimen. We used peripheral blood stem cells instead of bone marrow based on the hypothesis that



**Figure 1.** Disease-free survival (DFS) of all 50 patients in first remission treated with autologous bone marrow transplant and 4-hydroperoxycyclophosphamide-purged marrow.



**Figure 2.** Disease-free survival (DFS) of 50 patients in first remission treated with autologous bone marrow transplant and 4-hydroperoxycyclophosphamide-purged marrow by cytogenetic risk category. FAV, favorable cytogenetics; NON, unfavorable cytogenetics.

more rapid engraftment would reduce the overall toxicity of the transplant program. We gave a single course of moderately intensive postremission therapy to achieve further cytoreduction of the leukemia and to take advantage of a possible *in vivo* purging effect, collecting peripheral blood stem cells during the recovery phase from this chemotherapy.<sup>4,5</sup> Because our goal was to maximize the percentage of patients able to proceed to transplantation, the consolidation chemotherapy was developed as a compromise between giving intensive enough treatment to avoid a large number of early relapses but avoiding excessive toxicity that would result in patients dropping out from the treatment program.

We report here the success of this strategy in allowing excellent peripheral blood stem cell mobilization with rapid engraftment, decrease in toxicity, and the ability to get a high percentage of patients to transplant. The preliminary outcome results suggest that this approach compares favorably with other treatment options.

## METHODS

### Patients

Patients were accrued from 6 centers between May 1993 and June 1999. All patients gave written informed consent in accord with each institution's Committee on Human Research. Eligible patients were older than 17 years and up to age 70 years.

Patients in first remission were required to have de novo AML. Patients with prior myelodysplasia (MDS), myeloproliferative disease, or chemotherapy-related leukemia were excluded. Complete remission was defined as normal bone marrow morphology with <5% blasts, resolution of previously abnormal cytogenetics, no evidence of extramedullary leukemia, absolute neutrophil count (ANC) >1500/ $\mu$ L, and platelets >140,000/ $\mu$ L. Patients were required to remain in complete remission for at least 30 days but <6 months before study entry. We required adequate organ function with bilirubin <1.5 mg/dL, alkaline phosphates and asparatate transaminase (AST) <2 times the upper limit of normal, creatinine <2.0 mg/dL, cardiac ejection fraction >40%, and pulmonary carbon monoxide diffusion capacity >50%. Patients receiving previous postremission high-dose Ara-C (HDAC) (defined as more than 4 Ara-C doses of 2000 mg/m<sup>2</sup>) were ineligible, but patients may have received less intensive postremission therapy before study entry.

Patients were classified by cytogenetics as favorable if they had t(15,17), t(8,21), or inv16q. Patients with unequivocal French-American-British (FAB) M3 morphology without cytogenetic tests performed were also classified as favorable. Patients were classified as poor risk if they had monosomy of chromosomes 5 or 7, abnormal 7q, or complex abnormalities. Other patients were classified as intermediate risk, including those with normal cytogenetics, +8 and 11q23 abnormalities, and miscellaneous abnormalities or those for whom cytogenetics were not known.

We also treated patients with more advanced AML. These patients were in either second or third remission, had secondary leukemia based on evolution from prior MDS or prior chemotherapy, or had primary induction failure, defined as having failed to achieve complete remission after induction therapy with 6 days of HDAC plus daunorubicin but then achieving remission with salvage chemotherapy. Other requirements were similar to first-remission patients except that we required ANC >1000/ $\mu$ L, platelets >100,000/ $\mu$ L, and AST <3 times normal.

### **Step 1: Consolidation Chemotherapy**

Patients were treated with Ara-C 2000 mg/m<sup>2</sup> intravenously (IV) over 2 hours, q 12 hours  $\times$  8 doses on days 1–4, plus etoposide 40 mg/kg by continuous IV infusion over 96 hours on days 1–4. All chemotherapy was calculated based on corrected weight defined as ideal weight plus 25% of the difference between actual and ideal weight. G-CSF 5  $\mu$ g/kg daily subcutaneously was started on day 14 of therapy and continued until peripheral blood stem cell collection was completed. The dose of G-CSF could be escalated to 10  $\mu$ g/kg if stem cell collection was proceeding slowly.



## Stem Cell Collection

Stem cell collection was begun when the white blood cell count (WBC) was  $>10,000/\mu\text{L}$ . At the initiation of this study, not all centers had the capability of measuring CD34<sup>+</sup> cells. Therefore, the target for stem cell collection was initially either a CD34<sup>+</sup> cell dose  $>10\times 10^6/\text{kg}$  or a mononuclear cell count  $>15\times 10^8/\text{kg}$ . By June 1995, the MNC target was reduced to  $12\times 10^8/\text{kg}$ , and by November 1995, all centers had the capability of measuring CD34<sup>+</sup> cells and the collection target was a CD34<sup>+</sup> cell dose  $>10\times 10^6/\text{kg}$ . In November 1996, the CD34<sup>+</sup> cell dose target was reduced to  $>5\times 10^6/\text{kg}$ .

Leukaphereses were performed by institutional criteria, with processing of 12 to 18 liters of blood daily. A buffy coat was prepared by centrifugation and mixed in M199 media with 5% autologous plasma and 10% dimethylsulfoxide (DMSO) to achieve a final cell concentration of  $2.5\times 10^8$  cells/mL. The stem cell product was frozen in a controlled-rate freezer and stored in the liquid phase of liquid nitrogen. CD34<sup>+</sup> and colony-forming units-granulocyte/macrophage (CFU-GM) assays were done by institutional criteria. During the first 18 months of the study, patients had backup bone marrow collected after the completion of stem cell collection.

## Step 2: Autologous Stem Cell Transplantation

Patients were eligible to proceed to step 2 once they were out of the hospital for at least 4 weeks after completion of consolidation chemotherapy and were documented to be in continuous remission by a bone marrow test performed within 2 weeks of admission and by having peripheral blood counts with ANC  $>500/\mu\text{L}$  and platelets  $>50,000/\mu\text{L}$  (either improving or stable).

The preparative regimen consisted of busulfan 1 mg/kg orally every 6 hours for 16 doses (total dose 16 mg/kg) on days -7 through -4 followed by etoposide 60 mg/kg IV over 4-10 hours on day -3. As in step 1, all chemotherapy doses were calculated based on corrected weight. Peripheral blood stem cells were infused on day 0. G-CSF 5  $\mu\text{g}/\text{kg}$  daily subcutaneously was started on day 0 and continued until the ANC was  $>1500/\mu\text{L}$  for 2 consecutive days or  $>5000/\mu\text{L}$  for 1 day.

## Supportive Care

During consolidation chemotherapy, patients received fluoromethalone ophthalmic solution 0.1%, 2 drops qid on days 1-6. Amphotericin 0.3 mg/kg per day was started on day 5 and continued until ANC was  $>500/\mu\text{L}$ . During autologous stem cell transplantation, amphotericin 0.3 mg/kg per day was started when ANC was  $<500/\mu\text{L}$  and continued until ANC was  $>500/\mu\text{L}$ . Acyclovir 2 mg/kg IV q 12 hours was started on day -2 and continued until it could be

switched to acyclovir 200 mg po tid. This was continued for the first year after transplantation. *Pneumocystis carinii* pneumonia prophylaxis was maintained with trimethoprim/sulfamethoxazole 160 mg bid twice a week until at least 3 months after transplant or until CD4<sup>+</sup> lymphocyte count was >200/ $\mu$ L. Red blood cell and platelet transfusions were administered according to institutional criteria.

### Toxicity

Toxicity was graded according to the University of California San Francisco (UCSF) BMT Toxicity Grading Scale. Mucositis was scored as grade 2 (moderate) if the patient required narcotic analgesics or was unable to eat due to mucositis and grade 3 (severe) if >25% of the mucosa was ulcerated. Skin toxicity was scored as grade 2 (moderate) if the patient required narcotic analgesia and/or local care and grade 3 (severe) if significant desquamation and breakdown occurred.

### Statistical Evaluation

DFS was calculated from the date of the start of step 1 consolidation chemotherapy using Kaplan-Meier analysis on a Macintosh computer. Data were analyzed as of July 5, 2000.

## RESULTS

### Patients

One hundred thirty-three first-remission patients were treated. The median age was 39 years (range, 18–65 years) and 6 (5%) were >60 years of age. Ninety patients (68%) received induction chemotherapy with HDAC and daunorubicin. Eight patients (6%) received some prior postremission therapy. The median interval between achieving remission and study entry was 41 days (range, 23–185 days), and 9 patients were enrolled after intervals of >100 days.

Forty patients had favorable cytogenetics. Twenty-four patients had FAB M3. Nine of these patients had WBC >5000/ $\mu$ L, and 2 had WBC >100,000/ $\mu$ L. Ten patients received all-*trans* retinoic acid (ATRA) as part of induction chemotherapy, and 14 were treated in the pre-ATRA era. Eight patients had FAB M4Eo, and all 8 had inv16q. Eight patients had t(8,21). Seven patients had poor-risk cytogenetics. Eighty-six patients were classified as having intermediate-risk disease with normal cytogenetics, miscellaneous abnormalities, or cytogenetics not known. The intermediate-risk group included 5 patients with +8 and 3 with 11q23 abnormalities.

The advanced-disease patients had a median age of 44 years (range, 19–69 years). Ten were in second remission and 1 in third remission. Six had secondary

**Table 1.** Hematologic Recovery of Patients in First Remission (Days)\*

	<i>Step 1</i>	<i>Step 2</i>
ANC		
>500/ $\mu$ L	21 (17–31)	+9 (7–15)
>1000/ $\mu$ L	21 (17–32)	+9 (7–27)
Time to ANC <500/ $\mu$ L, d	12 (7–27)	5 (3–20)
Platelets		
>20,000/ $\mu$ L	23 (12–27)	+13 (0–359)
>50,000/ $\mu$ L	28 (17–72)	+20 (8–400+)
>100,000/ $\mu$ L	35 (18–400+)	+28 (9–400+)
Number of platelet transfusions	6 (1–34)	3 (0–100)
Red blood cell transfusions, units	5 (0–19)	3 (0–50)

\*Data are median (range); + indicates additional.

AML, 4 with prior MDS and 2 after chemotherapy for breast cancer. Eleven patients were in remission after failing to respond to HDAC-based induction therapy. Three of these had FAB M3 and responded to ATRA plus idarubicin, and 8 others were induced with idarubicin, HDAC, and etoposide.

### Step 1: Consolidation Chemotherapy

Consolidation chemotherapy was generally well tolerated. For first-remission patients, hematologic toxicity was as expected, with a median of 12 days with ANC <500/ $\mu$ L (Table 1). Patients required a median of 5 units (range, 0–19 units) of red blood cells and 6 platelet transfusions (range, 1–34). There was little nonhematologic toxicity, with median 0 days (range, 0–22 days) of parenteral nutrition and 0 days (range, 0–24 days) of narcotics (Table 2). There was no significant skin toxicity. Two patients experienced transient central nervous system neurotoxicity related to HDAC but recovered completely. There was little hepatotoxicity, with a median bilirubin of 1.0 mg/dL (range, 0.5–6.6 mg/dL). Seven patients had a peak bilirubin >3 mg/dL, and the highest bilirubin was 6.6 mg/dL. There were 2

**Table 2.** Nonhematologic Toxicity of Patients in First Remission\*

	<i>Step 1</i>	<i>Step 2</i>
Days of TPN	0 (0–22)	6 (0–34)
Days of narcotic use	0 (0–24)	7 (0–29)
Days until hospital discharge	25 (18–73)	+15 (9–59)
Peak bilirubin level (mg/dL)	1.0 (0.5–6.6)	0.9 (0.4–3.6)

\*Data are median (range); TPN, total parenteral nutrition; + indicates additional.

treatment-related deaths due to sepsis. Ten patients relapsed after completing consolidation and before transplantation.

Advanced-disease patients tolerated this chemotherapy similarly well. The median times to ANC  $>500/\mu\text{L}$  and  $>1000/\mu\text{L}$  were 21 days (range, 17–31 days) and 22 days (range, 17–33 days). The median times to platelets  $>20,000/\mu\text{L}$  and  $50,000/\mu\text{L}$  were somewhat longer than in first-remission patients, at 28 days (range, 11–118 days) and 32 days (range, 18–223 days), respectively. Nonhematologic toxicity was similar to first-remission patients, with most patients not requiring total parenteral nutrition (TPN) or narcotics, and the median peak bilirubin was 1.3 mg/dL (range, 0.7–43 mg/dL). There were no treatment-related deaths, but 1 patient developed severe multiorgan failure in the context of *Streptococcus viridans* sepsis and was judged too ill to proceed with transplantation.

### Stem Cell Collection

For first-remission patients, the median time to first stem cell collection was day 25 (range, 18–40 days) of treatment (Table 3). Patients underwent a median of 3 collections (range, 1–11). We initially set a very high CD34<sup>+</sup> target of  $10 \times 10^6/\text{kg}$ . As we developed more experience with this regimen, the CD34<sup>+</sup> cell target was reduced to  $5 \times 10^6/\text{kg}$ . If the stem cell collection results are analyzed based on a CD34<sup>+</sup> target of  $5 \times 10^6/\text{kg}$ , 59% (59 of 100 of patients for whom CD34<sup>+</sup> data are available) achieved this goal in 1 collection, and the mean number of collections to reach the target was 1.9 (range, 1–9). One hundred thirty of 131 patients had successful collections. One patient failed to mobilize during the period of sepsis. This patient subsequently had stem cells mobilized with G-CSF alone and proceeded to transplantation.

Advanced-disease patients also mobilized stem cells well. A median CD34<sup>+</sup> dose of  $13 \times 10^6/\text{kg}$  (range, 0– $235 \times 10^6/\text{kg}$ ) was collected in a median of 2 collections (range, 1–7). The median number of collections to reach a CD34<sup>+</sup> target dose of 5 was 1 (range, 1–5). Twenty-six of 28 patients had successful collections, both failures occurring in the context of sepsis.

**Table 3.** Stem Cell Collection in Patients in First Remission\*

Start day	25 (18–40)
Number of collections	3 (0–11)
Number of collections to achieve $>5 \times 10^6$ CD34 <sup>+</sup> cells/kg	1 (1–9)
Mononuclear cells, $\times 10^8/\text{kg}$	11 (0.5–57)
CD34 <sup>+</sup> cells, $\times 10^6/\text{kg}$	14.6 (1.8–230)
CFU-GM, $\times 10^4/\text{kg}$	193 (1.5–2100)

\*Data are median (range). CFU-GM, colony-forming units-granulocyte/macrophage.

## Step 2: Autologous Stem Cell Transplantation

One hundred twenty-one of 133 first-remission patients (91%) proceeded to transplantation. Two patients died during consolidation, and 10 relapsed before transplant. Engraftment after stem cell infusion was rapid, with ANC  $>500/\mu\text{L}$  by day 9, and with no patients reaching this landmark later than day 15 (Table 1). Median number of days spent with ANC  $<500$  was 5 (range, 3–20). Platelets recovered to  $>20,000/\mu\text{L}$  by day 13. Only 12 patients required  $>30$  days to reach this landmark, and only 2 patients required  $>100$  days. One of these patients never engrafted platelets and died on day 359 of sepsis, likely related to his continued use of an indwelling catheter. No patient was infused with back-up pelvic bone marrow.

Nonhematologic toxicity of the regimen was very acceptable (Table 2). Median number of days of TPN were 6, and median days of narcotic analgesia, 7. Skin toxicity was minimal, with median 0 days (range, 0–16 days) of grade 2 toxicity, and only 1 patient had  $>14$  days of grade 2 toxicity. No patient had  $>2$  days of severe (grade 3) skin toxicity. There was little hepatotoxicity, with median peak bilirubin of 0.9 mg/dL (range, 0.4–3.6 mg/dL) and no cases of veno-occlusive disease (VOD). Patients were discharged from the hospital by median day 15 (range, day 9–59). There were 2 treatment-related deaths. One was an iatrogenic death related to perforation of duodenum during endoscopy with resulting acute respiratory distress syndrome. One patient (mentioned above) who retained a central catheter because of failure to engraft platelets died of sepsis 1 year after transplantation.

Twenty-six of 28 advanced-disease patients were transplanted. Engraftment was similar to that seen in first-remission patients, with median times to ANC  $>500/\mu\text{L}$  and  $>1000/\mu\text{L}$  both being 10 days, and times to platelets  $>20,000/\mu\text{L}$  and  $50,000/\mu\text{L}$ , 12 and 18 days, respectively. A total of 6 days (range, 2–17 days) were spent with ANC  $<500/\mu\text{L}$ . Patients required a median of 3 platelet transfusions (range, 1–15) and 4 units of red blood cells (range, 0–17).

Nonhematologic toxicity in advanced-disease patients was also similar to that in first-remission patients. There was 1 treatment-related death from multiorgan failure. Median requirement for TPN was 7 days (range, 0–24 days), and for narcotics, 7 days (range, 0–22 days). The median peak bilirubin was 1.0 mg/dL (range, 0.4–7.1 mg/dL), and no cases of VOD were seen. Patients were discharged from the hospital on median day 16 (range, day 10–34).

## Treatment Outcome

We treated 133 patients in first remission (Table 4). During consolidation chemotherapy, there were 2 deaths and 10 early relapses. One hundred twenty-one patients proceeded to transplantation. During transplant, there were 2 treatment-

**Table 4.** Outcome of Patients in First Remission

	All	Cytogenetics		
		Favorable	Intermediate	Poor
Step 1	133	40	86	7
Death	2	0	2	0
Early relapse	10	1	5	4
Step 2	121	39	79	3
Death	2	1	1	0
Relapse	46	9	34	3
Second cancer	1	0	1	0
Continuing remission	72	29	43	0

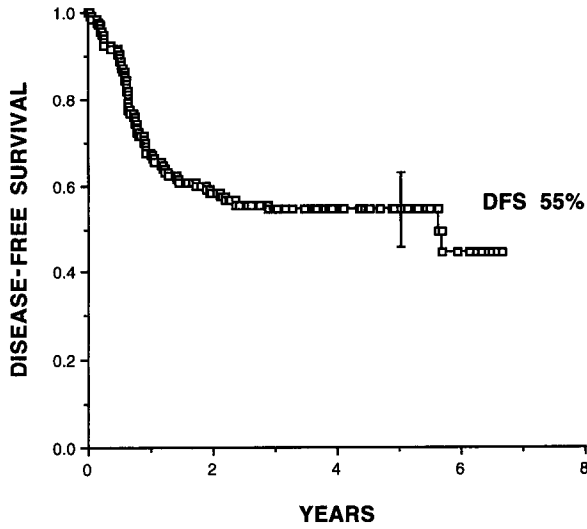
related deaths, and 46 relapses occurred after transplant. One patient died of pancreatic cancer 5.7 years after study entry. With median follow-up of 4.0 years (range, 1.0–6.9 years), 5-year DFS is 55% (95% confidence interval [CI] 46%–64%) (Figure 3).

As with nonablative therapy, cytogenetics were an important prognostic factor for relapse. For 40 favorable-risk patients, 5-year DFS is 72% (95% CI, 58%–86%) (Figure 4). For 24 FAB M3 patients, 5-year DFS is 75%, and both patients with WBC >100,000/ $\mu$ L relapsed. The 5-year DFS for 8 patients with FAB M4Eo is 88%, with 1 death and no relapses. The 5-year DFS for 8 patients with t(8,21) is 50%, with 4 relapses. For the 86 patients with intermediate-risk disease, 5-year DFS is 52% (95% CI, 38%–66%). Two of 5 patients with +8 and all 3 patients with 11q23 abnormalities remain well. All 7 patients with poor-risk cytogenetics relapsed either before or within 1 year of transplantation.

We treated 28 patients with advanced AML. Two patients did not proceed to autologous transplant. One remains in remission >4.3 years with no further therapy and the second >6 years after allogeneic transplant. Of the 26 patients who received autologous transplant, there was 1 treatment-related death and there were 12 relapses. With median follow-up of 3.9 years (range, 1.5–6.6 years), 5-year DFS is 53% (95% CI, 34%–72%) (Figure 5). All 7 patients with FAB M3 treated in second remission remain well.

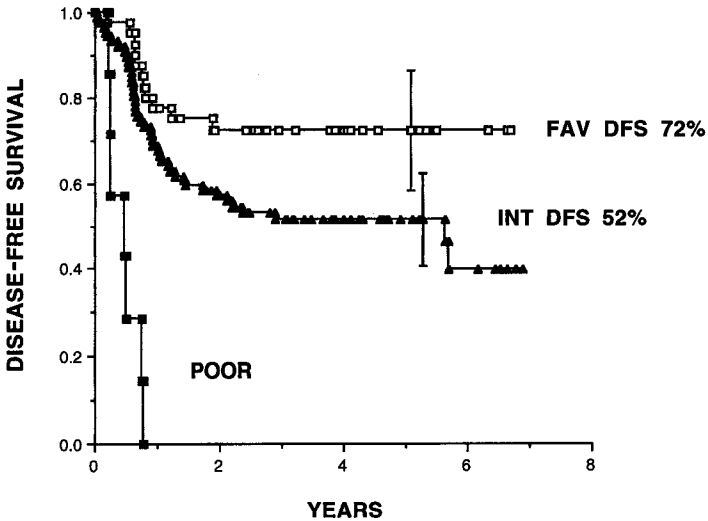
## DISCUSSION

This 2-step approach to autologous stem cell transplantation for AML is highly feasible, with 91% of the patients able to receive the intended therapy. This consolidation chemotherapy regimen of HDAC plus etoposide appears highly effective in mobilizing peripheral blood stem cells in both first- and subsequent-remission patients. Only 1 of 131 first-remission (and 2 of 28 advanced-disease) patients did

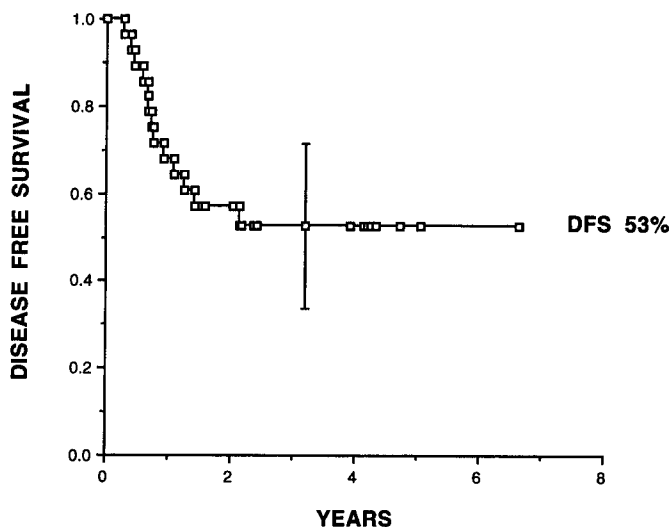


**Figure 3.** Disease-free survival (DFS) of all 133 first-remission patients entered on study.

not have an adequate stem cell collection. The median number of collections to reach a CD34<sup>+</sup> cell dose target  $>5 \times 10^6/\text{kg}$  was 1, and a total CD34<sup>+</sup> cell dose of  $15 \times 10^6/\text{kg}$  was collected in 3 aphereses. Engraftment of these peripheral blood



**Figure 4.** Disease-free survival (DFS) of first-remission patients entered on study according to cytogenetic risk group: 40 favorable (FAV), 86 intermediate (INT), and 7 poor.



**Figure 5.** Disease-free survival (DFS) of 28 patients with advanced disease.

stem cells was extremely rapid. Neutrophils  $>500/\mu\text{L}$  were reached by day 9, and the total number of days spent at ANC  $<500/\mu\text{L}$  was 5. This short duration of neutropenia likely contributed to the low treatment-related mortality and low morbidity. Platelets recovered to  $>20,000/\mu\text{L}$  by day 13, and only 2 patients reached this point later than day 100. Transfusion requirements were low, with patients requiring a median of 3 units of red blood cells and 3 platelet transfusions.

The toxicity of the transplant step was very acceptable and appeared markedly different from our experience with the identical regimen using 4HC-purged bone marrow. The median number of days requiring TPN fell from 38 to 6, and the requirement for parenteral narcotics, from 19 to 7 days. It is likely that rapid neutrophil recovery contributed to reduced gastrointestinal toxicity. Less easy to understand is the marked decrease in skin toxicity, which was one of the serious problems with our prior regimen. Previously, 20% of patients had severe skin toxicity lasting longer than 14 days, whereas no patient in the current study experienced this level of toxicity. In terms of resource utilization, the use during both treatment steps of 7 units of red blood cells and 9 platelet transfusions is far less than the 11 units of blood and 23 platelet transfusions required during autoBMT supported by 4HC-purged bone marrow. The total number of days of hospitalization was similar, 48 (2-step stem cell) vs. 49 (purged bone marrow) days.

Autologous transplantation has been pursued as a postremission therapy for AML based on the hope that the ablative regimen would reduce relapse and lead



to improved outcomes. However, the role of autologous transplant in the management of first-remission AML remains controversial. Two large phase 3 studies have been reported, with somewhat conflicting results.<sup>6,7</sup> A large European study demonstrated an improvement in DFS from autologous transplant, whereas an American study did not. However, both studies were plagued by the fact that a low percentage of patients received the intended therapy. In the European study, only 68% of remission patients reached the point of randomization/allocation, and of patients randomized to receive autologous transplant, only 74% did so. In the American study, a similar pattern was observed, with only 67% of remission patients reaching randomization/allocation and only 54% of patients randomized to autoBMT receiving the transplant.

For first-remission patients with favorable cytogenetic subtypes of acute leukemia, several treatment options can result in >50% likelihood of prolonged DFS.<sup>8,9</sup> Patients with FAB M3 and WBC <10,000/ $\mu$ L have 4-year DFS >70%, whereas those with higher WBC do more poorly: DFS <40%.<sup>10,11</sup> Patients with t(8,21) have prolonged DFS of 50%–70%, and those with inv16q have a DFS of 40%–60%.<sup>8,9,12,13</sup> Although autoSCT may not be necessary as a first treatment option in this favorable group of patients, the outcome appears to be at least as good, with no significant increase in treatment mortality.<sup>14</sup> Our patients with FAB M4Eo fared especially well, with no relapses in 8 patients, suggesting that initial autoBMT may be a valid approach. For the large group of patients with intermediate-risk AML, the projected DFS of 52% compares favorably to the 30% DFS reported after HDAC postremission therapy.<sup>15</sup>

This treatment approach also appears highly feasible and effective in patients with more advanced AML. Allogeneic transplant is often considered the treatment of choice, based on its ability to cure 30%–40% of patients in second remission.<sup>16</sup> Based on our preliminary results, autoSCT appears to be an excellent treatment option for patients in second remission. If our results in patients with FAB M3 in second remission are confirmed, autologous transplant may be preferable to allogeneic transplant in this setting. The Cancer and Leukemia Group B (CALGB) is currently conducting a phase 2 trial using this same 2-step approach and may be able to confirm the low mortality and good efficacy of the approach.

Autologous stem cell transplantation remains a promising therapy in the management of AML.<sup>17</sup> The 2-step approach outlined here allows a high percentage of patients to remain in remission, yield an adequate dose of stem cells that can engraft rapidly, and proceed to transplantation. In the setting of rapid engraftment, patients can tolerate very intensive preparative regimens with little mortality and very acceptable morbidity. We await confirmation of these results in the Cooperative Group setting.

## REFERENCES

1. Linker CA, Ries CA, Damon LE, Rugo HS, Wolf JL. Autologous bone marrow transplantation for acute myeloid leukemia using 4-hydroperoxycyclophosphamide-purged bone marrow and the busulfan/etoposide preparative regimen: a follow-up report. *Bone Marrow Transplant* 22:865–872, 1998.
2. Linker CA, Ries CA, Damon LE, Rugo HS, Wolf JL. Autologous bone marrow transplantation for acute myeloid leukemia using busulfan plus etoposide as a preparative regimen. *Blood* 81:311–318, 1993.
3. Gorin NC, Aegerter P, Auvert B, et al. Autologous bone marrow transplantation for acute myelocytic leukemia in first remission: a European survey of the role of marrow purging. *Blood* 75:1606–1614, 1990.
4. Linker CA, Ries CA, Damon LE, et al. Autologous stem cell transplantation for acute myeloid leukemia in first remission. *Biol Blood Marrow Transplant* 6:50–57, 2000.
5. Stein AS, O'Donnell MR, Chai A, et al. In vivo purging with high-dose cytarabine followed by high-dose chemotherapy and reinfusion of unpurged bone marrow for adult acute myelogenous leukemia in first complete remission. *J Clin Oncol* 14:2206–2216, 1996.
6. Zittoun RA, Mandelli F, Willemze R, et al. Autologous or allogeneic bone marrow transplantation compared with intensive chemotherapy in acute myelogenous leukemia. *N Engl J Med* 332:217–223, 1995.
7. Cassileth PA, Harrington DP, Appelbaum FR, et al. Chemotherapy compared with autologous or allogeneic bone marrow transplantation in the management of acute myeloid leukemia in first remission. *N Engl J Med* 339:1649–1656, 1998.
8. Bloomfield C, Lawrence D, Arthur DC, Berg DT, Schiffer CA, Mayer RJ. Curative impact of intensification with high-dose cytarabine in acute myeloid leukemia varies by cytogenetic group [abstract]. *Blood* 84:111a, 1994.
9. Grimwade D, Walker H, Oliver F, et al. The importance of diagnostic cytogenetics on outcome in AML: analysis of 1,612 patients entered into the MRC AML 10 trial. *Blood* 92:2322–2333, 1998.
10. Asou N, Adachi K, Tamura J, et al. Analysis of prognostic factors in newly diagnosed acute promyelocytic leukemia treated with all-trans retinoic acid and chemotherapy. Japan Adult Leukemia Study Group. *J Clin Oncol* 16:78–85, 1998.
11. Fenaux P, Chastang C, Castaigne S, et al. Long term follow-up confirms the superiority of ATRA combined with chemotherapy (CT) over CT alone in newly diagnosed acute promyelocytic leukemia (APL 91 trial) [abstract]. The European APL Group. *Blood* 90:331a, 1997.
12. Garson OM, Matthews JP, Bishop JF, Australian Leukaemia Study Group. Prognostic significance of cytogenetic abnormalities in adult acute myeloid leukemia patients treated with high dose cytarabine [abstract]. *Blood* 86:600a, 1995.
13. Hiddemann W, Fonatsch C, Wormann B, et al. Cytogenetic subgroups of AML and outcome from the high dose versus conventional dose Ara-c as part of double induction therapy [abstract]. *Blood* 86:267a, 1995.
14. Gale RP, Horowitz MM, Weiner RS, et al. Impact of cytogenetic abnormalities on outcome of bone marrow transplants in acute myelogenous leukemia in first remission. *Bone Marrow Transplant* 16:203–208, 1995.

15. Mayer RJ, Davis RB, Schiffer CA, et al. Intensive postremission chemotherapy in adults with acute myeloid leukemia. *N Engl J Med* 331:896–903, 1994.
16. Frassoni F, Labopin M, Gluckman E, et al. Results of allogeneic bone marrow transplantation for acute leukemia have improved in Europe with time: a report of the Acute Leukemia Working Party of the European Group for Blood and Marrow Transplantation (EBMT). *Bone Marrow Transplant* 17:13–18, 1996.
17. Gorin NC: Autologous stem cell transplantation in acute myelocytic leukemia [review]. *Blood* 92:1073–1090, 1998.

# **Autologous Stem Cell Transplantation for Acute Myelocytic Leukemia in Patients >60 Years of Age**

***N.C. Gorin, M. Labopin, L. Fouillard, F. Frassoni,  
for the Acute Leukaemia Working Party of the  
European Group for Blood and Marrow Transplantation***

*Hopital Saint-Antoine AP-HP, European Data Management Office  
(Centre International Greffes) and Centre de Recherches Claude Bernard,  
Institut des Cordeliers, Paris, France*

## **INTRODUCTION**

There is presently no consensus on the best therapeutic approach to acute myelocytic leukemia (AML) in elderly patients, and results of numerous randomized studies comparing conventional chemotherapy, allogeneic bone marrow transplantation, and autografting, available for patients <55 years of age,<sup>1-4</sup> do not apply beyond this age limit. This question is of considerable importance because AML is primarily a disease of older individuals, with a median age of onset of ~65 years.

A previous study of the European Group for Blood and Marrow Transplantation (EBMT)<sup>5</sup> showed the feasibility of autologous bone marrow transplantation in patients >50 years of age. We investigated the outcome of AML patients 60 years and older who received an autograft within the EBMT.

## **PATIENT POPULATION**

The population consisted of 193 patients from 60 to 74 years of age (median, 63 years) autografted from January 1984 to December 1998; 147 patients were autografted in first clinical remission (CR1). The source of stem cells was peripheral blood in 128, bone marrow in 51 (13 with in vitro treatment), and a combination of both in 14. The median follow-up was 14 months (range, 1-100 months). Several pretransplant regimens were used, including total body irradiation (TBI) in 34.

## RESULTS

### Engraftment

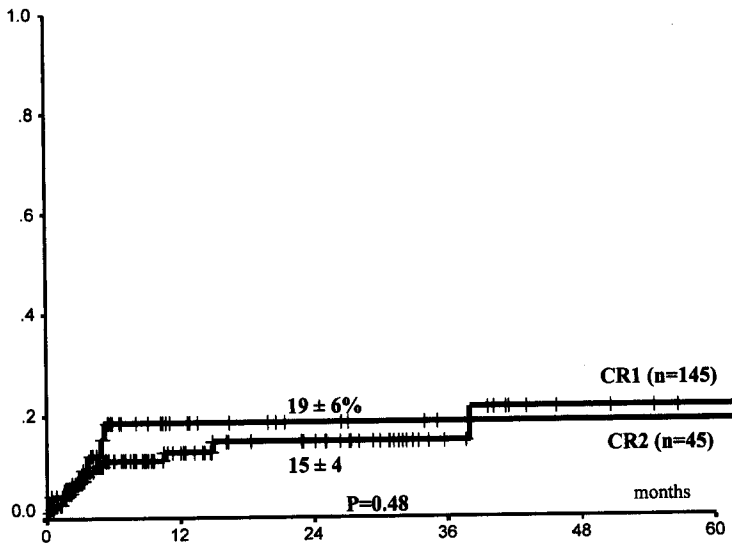
Ninety-eight percent of all patients and 99% of those transplanted in CR1 had successful engraftment. Engraftment of leukocytes occurred on day 14 (range, 6–57 days), neutrophils on day 15 (range, 7–71 days), and platelets on day 30 (range, 9–894 days).

### Outcome

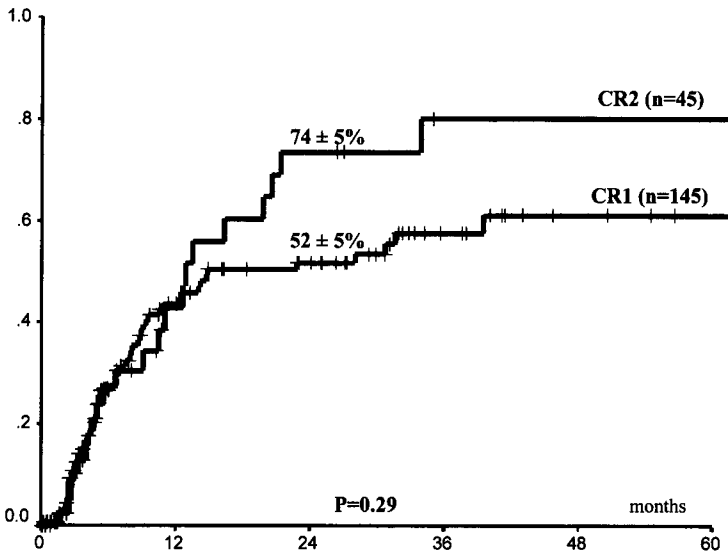
The 3-year transplant-related mortality (TRM) (Figure 1) reached  $16\% \pm 3\%$  in all patients and  $15\% \pm 4\%$  in those transplanted in CR1. In patients autografted in CR1, the relapse incidence was  $44\% \pm 5\%$  at 1 year and  $58\% \pm 5\%$  at 3 years (Figure 2); the leukemia-free survival (LFS) (Figure 3) and overall survival (Figure 4) rates were  $36\% \pm 5\%$  and  $47\% \pm 5\%$ , respectively, at 3 years.

### Patient Age and Sex

Median age of the population was 63 years. The TRM at 3 years was  $23\% \pm 5\%$  in men and  $8\% \pm 3\%$  in women ( $P=.07$ ). The relapse incidence was  $67\% \pm 7\%$  in those >63 years old and  $59\% \pm 7\%$  in those younger ( $P=.12$ ).



**Figure 1.** Transplant-related mortality of patients >60 years old autografted for acute myelocytic leukemia. CR, clinical remission.



**Figure 2.** Relapse incidence of patients >60 years old autografted for acute myelocytic leukemia. CR, Clinical remission.

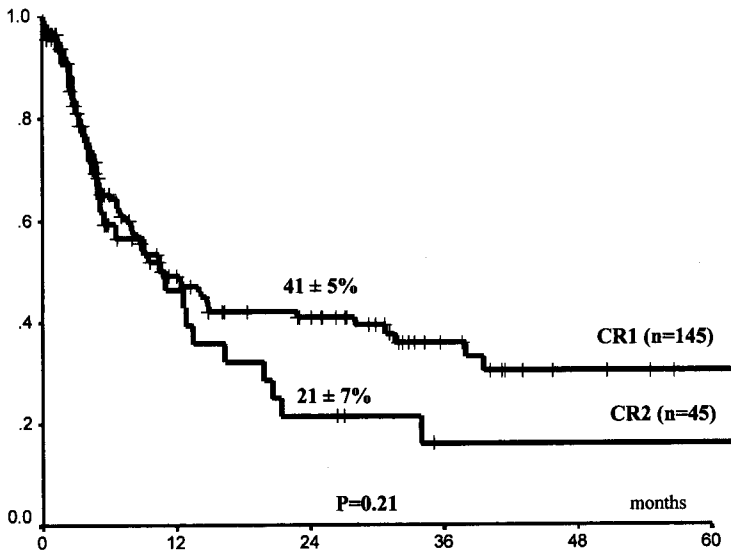
### Status at Transplant

TRM, relapse incidence, and LFS were identical in CR1 and CR2. The overall survival at 3 years, however, was 47% ± 5% in CR1 and 23% ± 8% in CR2 ( $P=0.04$ ) (Figure 2).

### Source and Dose of Stem Cells

In all, 128 patients (109 in CR1) received peripheral blood (PB) stem cells, 51 (30 in CR1) bone marrow, and 14 (8 in CR1) both marrow and PB stem cells. Because the population receiving both marrow and PB was small, and PB in most of them was added in an effort to supplement a poor marrow collection, patients receiving marrow only were combined with those receiving both.

In patients transplanted in CR1, the 3-year relapse incidence was 44% ± 11% for those receiving marrow or marrow and PB vs. 63% ± 6% for those receiving PB only ( $P=0.04$ ). However, patients autografted in CR1 who received the higher PB doses (above the median value,  $6.04 \times 10^4$ ), had a lower relapse rate (47% ± 11% vs. 79% ± 9%;  $P < 0.01$ ).



**Figure 3.** Leukemia-free survival of patients >60 years old autografted for acute myelocytic leukemia. CR, clinical remission.

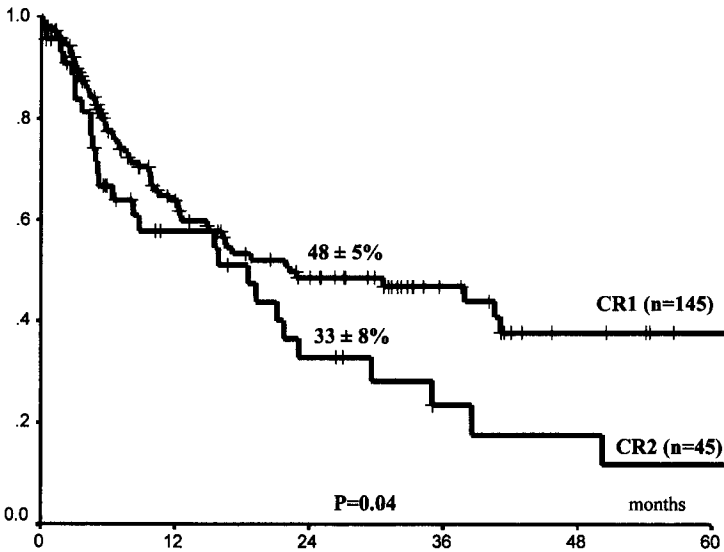
### Date of Transplant

The median date for all transplants performed was March 1996. There was a significant improvement for patients transplanted recently: for those in CR1, the relapse incidence was 41%  $\pm$  8% vs. 65%  $\pm$  6% ( $P=0.01$ ), the LFS 53%  $\pm$  8% vs. 28%  $\pm$  5% ( $P=0.01$ ), and the overall survival 72%  $\pm$  7% vs. 36%  $\pm$  6% ( $P=0.02$ ).

### DISCUSSION

The information provided by this analysis is of 3 kinds: 1) that autografting indeed is feasible, 2) that recent improvement has been obtained even in this category of older patients, and 3) that the source of stem cells is important to take into account because lower relapse rates were observed in patients receiving bone marrow vs. PB. In patients receiving PB, those for whom the doses of colony-forming units-granulocyte/macrophage (CFU-GM) collected were above the median did better.

Regarding the characteristics of the graft, previous studies have shown both the origin and the dose of stem cells infused to matter: PB has been associated with an increased relapse rate in the early series and has been attributed to collection of stem cells immediately after induction of remission, leading to contamination of



**Figure 4.** Overall survival of patients >60 years old autografted for acute myelocytic leukemia. CR, clinical remission.

the graft by mobilized leukemic progenitors.<sup>6,7</sup> More recent experience has shown lower relapse rates when using leukapheresis products collected after several consolidation courses to take advantage of *in vivo* purging.<sup>8,9</sup> In the present study, the number of patients was too small to determine the impact of leukapheresis timing on outcome but, because of the reduced tolerance of elderly patients to chemotherapy, it is likely that many had leukapheresis initiated as early as possible in the course of the disease with limited prior *in vivo* purging. The dose of stem cells infused has been shown to be of importance in the context of autografting AML patients with marrow either purged by cyclophosphamide derivatives<sup>10</sup> or unpurged.<sup>2</sup> A reduction in the relapse rate and an increase in LFS has been shown in patients receiving doses of CFU-GM/kg evaluated at collection over the median value. A stem cell competition effect has been postulated in which an expanded normal stem cell pool expresses a growth advantage and/or a higher resistance (eg, to inhibitors of leukemic origin) when faced with a minimal residual tumor population. In the present study, the findings that bone marrow was associated with lower relapse incidence and better LFS is consistent with previous observations.

In conclusion, the present survey indicates that autologous stem cell transplantation is a potential therapeutic approach for AML patients >60 years of age, especially since results have recently improved. Marrow may be a better source of stem cells than leukaphereses collected without sufficient *in vivo* purging.



## REFERENCES

1. Zittoun RA, Mandelli F, Willemze R, et al. Autologous or allogeneic bone marrow transplantation compared with intensive chemotherapy in acute myelogenous leukemia. European Organization for Research and Treatment of Cancer (EORTC) and the Gruppo Italiano Malattie Ematologiche Maligne dell'Adulto (GIMEMA) Leukaemia Cooperative Groups. *N Engl J Med* 332:217–223, 1995.
2. Burnett AK, Goldstone AH, Stevens RM, et al. Randomised comparison of addition of autologous bone marrow transplantation to intensive chemotherapy for acute myeloid leukaemia in first remission: results of MRC-AML 10 trial. UK Medical Research Council Adult and Children's Leukaemia Working Parties. *Lancet* 351:700–708, 1998.
3. Harousseau JL, Cahn JY, Pignon B, et al. Comparison of autologous bone marrow transplantation and intensive chemotherapy as postremission therapy in adult acute myeloid leukaemia. The Groupe Ouest Est Leucemies Aigues Myeloblastiques (GOELAM). *Blood* 90:2978–2986, 1997.
4. Cassileth PA, Harrington DP, Appelbaum FR, et al. Chemotherapy compared with autologous or allogeneic bone marrow transplantation in the management of acute myeloid leukaemia in first remission. *N Engl J Med* 339:1649–1656, 1998.
5. Cahn JY, Labopin M, Mandelli F, et al. Autologous bone marrow transplantation for first remission acute myeloblastic leukaemia in patients older than 50 years: a retrospective analysis of the European Group for Blood and Marrow Transplantation. *Blood* 85:575–579, 1995.
6. Mehta J, Powles R, Singhal S, Treleaven J. Peripheral blood stem cell transplantation may result in increased relapse of acute myeloid leukaemia due to reinfusion of a higher number of malignant cells. *Bone Marrow Transplant* 15:652–653, 1995.
7. Laporte JP, Gorin NC, Feuchtenbaum J, et al. Relapse after autografting with peripheral blood stem cells. *Lancet* ii:1393, 1987.
8. de la Rubia J, Sanz MA. Autologous peripheral blood stem cell transplantation for acute leukaemias. *Baillières Best Pract Res Clin Haematol* 12:139–150, 1999.
9. Reiffers J, Labopin M, Sanz M, et al. Autologous blood cell versus marrow transplantation for acute myeloid leukaemia in complete remission: an EBMT retrospective analysis. *Bone Marrow Transplant* 25:1115–1119, 2000.
10. Gorin NC, Labopin M, Laporte JP, et al. Importance of marrow dose on engraftment and outcome in acute leukemia: models derived from patients autografted with mafosfamide-purged marrow at a single institution. *Exp Hematol* 27:1822–1830, 1999.

# Peripheral Blood Progenitor Cell Transplantation for Acute Myeloblastic Leukemia in First Remission

*Javier de la Rubia, M.A. Sanz*

*Hematology Service, University Hospital La Fe, Valencia, Spain*

## ABSTRACT

Between November 1989 and May 2000, 65 patients with acute myeloblastic leukemia (AML) in first complete remission (CR1) underwent autologous peripheral blood stem cell transplantation (autoPBSC) using 2 consecutive protocols. In the first group (group A, 50 patients) peripheral blood stem cells (PBSCs) were collected after induction and consolidation (25 patients) or after consolidation only (25 patients). The subsequent 15 patients (group B) received induction and consolidation and 1 additional chemotherapy course with high-dose cytosine arabinoside (Ara-C) ( $1 \text{ g/m}^2$  per 12 hours  $\times$  4 days) and mitoxantrone ( $12 \text{ mg/m}^2/\text{day} \times 3$  days) before PBSC collection. The conditioning regimen consisted of busulfan  $16 \text{ mg/kg}$  and cyclophosphamide  $200 \text{ mg/kg}$  in 63 patients. Two patients in group B underwent autoPBSC after conditioning with busulfan  $16 \text{ mg/kg}$ , VP-16  $40 \text{ mg/kg}$ , and Ara-C  $3 \text{ g/m}^2$  per 12 hours  $\times$  2 days plus granulocyte colony-stimulating factor (G-CSF) on days  $-9$  to  $-2$ . Pretransplant characteristics were similar in the 2 groups, except patients were older in group B (41 vs. 49 years;  $P=.07$ ). Hematopoietic engraftment was slightly quicker in group A, with median time to reach both  $0.5 \times 10^9$  neutrophils/L and  $20 \times 10^9$  platelets/L of 12 days; times were 13 and 18 days, respectively, in group B. There were 3 graft failures (4.6%), all in group A, and 4 transplant-related deaths (6%), 3 in group A and 1 in group B. No significant differences were observed for relapse (67% at 7 years in group A and 65% at 18 months in group B). Likewise, the actuarial disease-free survival (DFS) was not significantly different between the 2 groups (28% vs. 33%). Finally, no differences in outcome were observed according to the number of colony-forming units-granulocyte/macrophage (CFU-GM) or CD34<sup>+</sup> cells administered.

In conclusion, in our series, limiting PBPC collections after high-dose Ara-C did not reduce relapse rate. Likewise, no differences were observed in DFS according to the dose of progenitors administered.

## INTRODUCTION

High-dose chemotherapy followed by autologous hematopoietic stem cell transplantation is commonly applied as postremission treatment in patients with AML as an alternative to allogeneic marrow transplantation.<sup>1</sup> As in other diseases, PBPCs are being increasingly used as the source of hematopoietic progenitor cells for autografting in AML. The main benefits of autoPBSCT are derived from a faster hematopoietic recovery with a subsequent lower morbidity and mortality, shorter hospitalization, probable reduction in cost, and the potential to perform autologous transplants in older patients.

In the first reported series of patients with AML in first remission undergoing autoPBSCT, PBPCs were collected during hematologic recovery after chemotherapy given for induction, consolidation, or both. AutoPBSCT was performed immediately thereafter.<sup>2-6</sup> In these patients, leukemic relapse was the most frequent cause of treatment failure, ranging from 49% to 60% at 2-3 years.<sup>2-6</sup> In an attempt to reduce the risk of relapse (RR), approaches that include changes in the number of courses and dose intensity of chemotherapy administered before transplantation, as well as the timing of PBPC collection or new conditioning regimens, have been taken.<sup>7-11</sup>

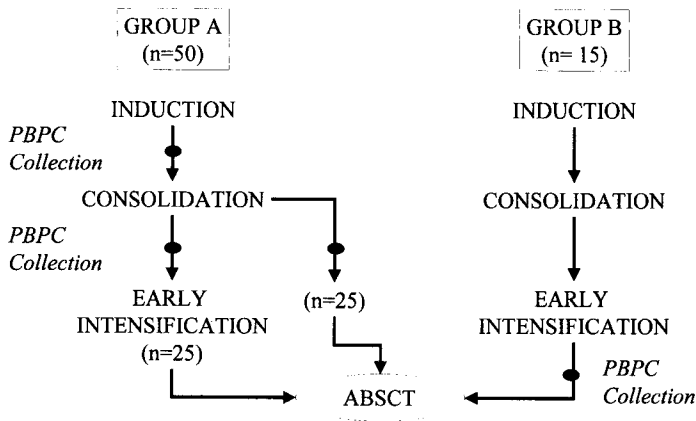
In this article, we report the results of autoPBSCT in 65 patients with AML in first remission performed at our institution in 2 consecutive protocols. In the first 50 patients, PBPC collections were performed during hematologic recovery after chemotherapy given for induction, consolidation, or both. In the remaining 15 cases, PBPC collections were done only after the administration of an additional intensification course with intermediate-dose Ara-C and mitoxantrone.

## PATIENTS AND METHODS

From November 1989 through May 2000, patients with *de novo* AML, excluding acute promyelocytic leukemia, diagnosed at our institution were eligible for the study. Up to June 1997, PBPC collections were planned after induction and/or consolidation chemotherapy.<sup>5,6</sup> Fifty patients are included in this protocol (group A). In July 1997, we started a new therapeutic protocol that planned to perform PBPC collections after the administration of a chemotherapy course with high-dose Ara-C (1 g/m<sup>2</sup> per 12 hours  $\times$  4 days) and mitoxantrone (12 mg/m<sup>2</sup>/day  $\times$  3 days) (group B). Figure 1 shows the therapeutic approach followed in the 2 groups.

### PBPC Collection

Characteristics of PBPC collection and cryopreservation have been described elsewhere.<sup>5,6</sup> Briefly, in group A, leukaphereses were performed during hemato-



**Figure 1.** Autologous blood stem cell transplantation (ABSC) in acute myeloblastic leukemia in first remission. Therapeutic approach followed in the 2 study groups. PBPC, peripheral blood progenitor cell.

poietic recovery after induction and/or consolidation chemotherapy, when the white blood cell count was above  $1 \times 10^9/L$  for 2 consecutive days. In group B, PBPC collections were performed daily only after intensification. In every case, leukaphereses were performed using a continuous flow blood cell separator (twice the patient's calculated blood volume). An estimate of the number of progenitor cells in each apheresis bag was determined by fluorescence-activated cell separation analysis of  $CD34^+$  cells (HPCA-2; Becton Dickinson, Mountain View, CA) and 14-day CFU-GM assay.

### Bone Marrow Collection

Overall, 55 patients (48 in group A and 7 in group B) underwent bone marrow harvesting in first remission. In group A, bone marrow was harvested after consolidation, and in group B, harvesting was done after intensification.

### Stem Cell Cryopreservation and Transfusion

The marrow and aphereses were not purged and were frozen in a controlled-rate freezer in the vapor phase of liquid nitrogen (Kryo 10; Planner Biomed Products, Middlesex, UK). The frozen cells were then transferred to liquid nitrogen and stored at  $-196^\circ C$ . Thawing was performed rapidly in a  $38^\circ C$  waterbath without removing the dimethylsulfoxide. The cell suspension was immediately injected into a Hickman catheter placed in a central vein.

## Transplant-Related Mortality

Every death of any cause during the first 100 days after transplant was considered a procedure-related death.

## Conditioning Regimen

All patients in group A and 6 of 9 group B patients were conditioned with busulfan 4 mg/kg po in divided doses daily for 4 days (total dose, 16 mg/kg) and cyclophosphamide 50 mg/kg daily intravenously on 4 consecutive days (total dose, 200 mg/kg). Three patients in group B underwent autoPBSCT after conditioning with busulfan (16 mg/kg), idarubicin (Vepeside) (40 mg/kg), and Ara-C (3 g/m<sup>2</sup> per 12 h × 2 days) plus G-CSF (days -9 to -2) according to the scheme described by Gondo et al.<sup>11</sup>

## Statistical Analysis

All data were analyzed as of May 31, 2000. Raw proportions were compared by  $\chi^2$  test. Transplant outcome was analyzed with respect to overall survival (OS), DFS, and RR. OS time was defined as time from transplant until death from any cause or until last follow-up evaluation for patients who were alive. DFS was calculated from the time of transplant to the date of death, relapse, or last follow-up. Time to relapse was calculated from the time between autoPBSCT and relapse. The RR was defined as the cumulative probability of relapse, ignoring (censoring) death in CR. Survival, DFS, and relapse curves were plotted according to the method of Kaplan and Meier.<sup>12</sup> Statistical comparison between different actuarial curves were based on log-rank tests. Student's *t* test was used to analyze differences between 2 independent means. All calculations were performed by the BMDP program.<sup>13</sup>

## RESULTS

### Patient Characteristics

Characteristics at diagnosis of the patient population undergoing autoPBSCT are given in Table 1. Age was higher in group B patients than in group A (49 vs. 42 years; *P*=.07). There were no significant differences in the distribution of patients by sex, white blood cell count at diagnosis, or French-American-British (FAB) subtype between the 2 treatment groups. The interval from diagnosis to transplant was higher in group B patients (176 vs. 230 days; *P*=.001). The karyotypic findings were classified as low risk [inv(16), t(8;21), intermediate normal, +8, +21, +22, 7q-, 9q-,

**Table 1.** Patient Characteristics at Diagnosis\*

	Group A	Group B	P
Number of patients	50	15	
Sex			
Male	28	7	
Female	22	8	
Age, y			
Median	42	54	.07
Range	14–66	18–66	
FAB subtype			
M0	1	1	
M1 or M2	28	9	
M3	1	0	
M4 or M5	14	4	
M6 or M7	6	1	
White blood cell count, $\times 10^9/L$			
Median	16	7.7	
Range	1–186	1.6–58	
Interval from diagnosis to autoPBSCT, d			
Median	176	230	.001
Range	88–335	165–308	
Cytogenetics†			
Low risk	2	0	
Intermediate risk	22	11	
High risk	4	3	

\*AutoPBSCT, autologous peripheral blood stem cell transplantation; FAB, French-American-British. †Data available in 42 cases.

abn(11q23), other numerical or structural abnormalities] and high risk [–5, –7, 5q–, abn(3q), complex] according to Grinwade et al.<sup>14</sup> Results were available in 42 patients (28 in group A and 14 in group B), and no differences were observed between the groups of patients (Table 1).

### PBPC Collection

The median number of leukaphereses per patient was 6 (range, 2 to 10) in group A and 3 (range, 1 to 6) in group B ( $P=.002$ ). Median number of mononuclear cells (MNC), CFU-GM, and CD34<sup>+</sup> cells administered is shown in Table 2. The total number of CD34<sup>+</sup> cells obtained was greater in group A (median,  $11 \times 10^6/kg$ ) than in group B (median,  $5.7 \times 10^6/kg$ ). In contrast, median CFU-GM ( $55.4 \times 10^4/kg$ ) and MNC ( $10.6 \times 10^8/kg$ ) collected were higher in group B.

**Table 2.** Progenitor Cells Administered\*

	Group A	Group B	P
<i>n</i>	50	15	
Number of leukaphereses			
Median	6	3	.002
Range	2–10	1–6	
MNC, $\times 10^8/\text{kg}$			
Mean	9.6	12.2	
Range	2.3–34.7	0.1–35	
CFU-GM, $\times 10^4/\text{kg}$			
Mean	88.6	81.3	
Range	0.1–228.5	0.8–289.3	
CD34 <sup>+</sup> cells, $\times 10^6/\text{kg}$			
Mean	29.04	13.4	
Range	1.3–145	0.9–116.2	

\*CFU-GM, colony-forming units-granulocyte/macrophage; MNC, mononuclear cells.

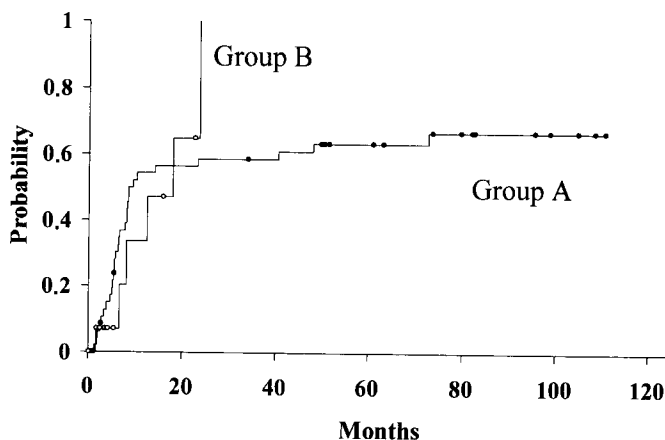
### Engraftment

Sixty of 65 patients engrafted. Two patients died, on day 3 and 14, and were considered not evaluable for engraftment. The remaining 3 patients, all from group A, developed graft failure. Median time to achieve ANC  $>0.5 \times 10^9/\text{L}$  was 12 days (range, 10–23 days) and 13 days (range, 11–18 days) in groups A and B, respectively. Forty-four of 50 patients in group A recovered  $20 \times 10^9$  platelets/L in a median of 12 days (range, 6–199 days). The remaining 6 patients did not achieve a self-sustaining platelet count greater than  $20 \times 10^9/\text{L}$  due to graft failure (3 cases) or death (3 cases). On the other hand, 14 of 15 patients in group B recovered  $20 \times 10^9$  platelets/L in a median of 11 days (range, 6 to 199 days), and 1 patient died too early for evaluation.

The 3 patients who failed to engraft received backup autologous bone marrow, on days 25, 41, and 61. Two also received G-CSF or granulocyte-macrophage (GM)-CSF. One patient died before recovery of marrow function, whereas complete hematologic reconstitution occurred in the remaining 2 patients.

### AutoPBSCT-Related Complications

Fever was observed in 56 patients (93%). Infection was microbiologically documented in 21 cases (11 with bacteremia), clinically documented in 25 (1 pneumonia), and possible in 10. Moderate to severe mucositis was observed in 53 cases (81%), requiring opioid analgesics, total parenteral nutrition, or



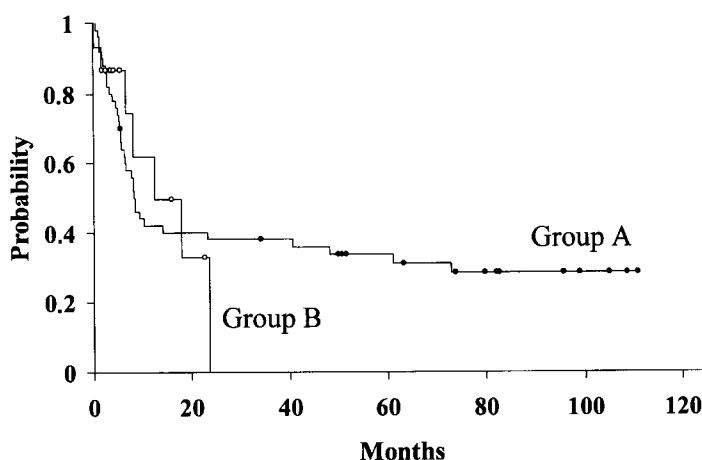
**Figure 2.** Autologous peripheral blood stem cell transplantation in acute myeloblastic leukemia in first remission. Comparison of the actuarial risk of relapse between the 2 study groups. Tick marks indicate patients without relapse.

both. Veno-occlusive disease (VOD) occurred in 8 patients (12%), all in group A, and was severe in 2. Transplant-related mortality (TRM) occurred in 5 patients (7.7%), 4 in group A (8%) and 1 in group B (6.6%). The causes of death were VOD (2 cases), intracerebral hemorrhage (2 cases), and bacterial infection (1 case). Finally, 1 patient in group A developed a secondary neoplasia (colon adenocarcinoma) 56 months after transplant and died 5 months later while in CR.

### Outcome

Thirty-six of 65 patients relapsed (55%), a median of 10 months (range, 1 to 73 months) after autoPBSCT. Thirty patients in group A (60%) relapsed, 2 to 73 months after autoPBSCT. In group B, with a shorter follow-up, 6 patients (40%) relapsed, between 2 and 18 months after autoPBSCT. Median time to relapse after autoPBSCT in group A and B was 8.5 months (range, 1 to 73 months) and 13 months (range, 2 to 18 months), respectively. Cumulative RR after transplantation was 68% at 6 years. The actuarial RR was 67% (95% confidence interval [CI], 60%–74%) in group A and 65% (95% CI, 46%–84%) in group B (Figure 2). The overall DFS was 27% at 6 years (95% CI, 21%–34%). The actuarial DFS was 28% (95% CI, 22%–34%) in group A and 33% (95% CI, 16%–50%) in group B (Figure 3). Finally, no differences in DFS or RR were observed according to the number of CFU-GM or CD34<sup>+</sup> cells administered.





**Figure 3.** Autologous peripheral blood stem cell transplantation in acute myeloblastic leukemia in first remission. Comparison of the actuarial disease-free survival between the 2 study groups. Tick marks indicate patients alive and disease-free at the time of last contact.

## DISCUSSION

PBPCs can be easily collected in AML patients after mobilization with chemotherapy, growth factors, or both. Likewise, short-term hematopoietic recovery after autoPBSCT is faster than that observed after autologous bone marrow transplantation (autoBMT). Thus, PBPCs have facilitated the administration of high-dose chemotherapy with autologous stem cell support in AML. However, relapse still remains the most frequent cause of treatment failure after autoPBSCT.<sup>1</sup> Intensification of chemotherapy to diminish the leukemic burden before transplant is widely used to prevent relapse. Also, several series have reported PBPC collection after administration of intermediate- or high-dose Ara-C (HDAC).<sup>7-11</sup> This strategy has been generally well tolerated, with a TRM rate similar to that observed in early clinical studies. Despite the administration of higher doses of chemotherapy before PBPC collection, hematologic reconstitution after autoPBSCT was as fast as in the first reported series, with a median time to reach polymorphonuclear cells  $0.5 \times 10^9/L$  and platelets  $20 \times 10^9/L$  ranging from 12 to 15 days and 11 to 16 days, respectively.<sup>7-11</sup> Finally, this strategy has shown an improvement in DFS and an important decrease in RR.

The source of hematopoietic progenitor cells, peripheral blood or bone marrow, could have potential implications in the long-term outcome of autografting in AML patients. In terms of speed of engraftment, the different series including autoPBSCT demonstrate that short-term hematopoietic recovery, especially

platelet engraftment, is faster than that observed after autoBMT.<sup>1</sup> The rapid hematologic reconstitution of autoPBSCT patients decreases the risks related to granulocytopenia and thrombocytopenia and makes autoPBSCT a safer procedure than autoBMT. In fact, protracted thrombocytopenia is a well-recognized consequence of autoBMT in AML,<sup>15</sup> and in a recent series of autoBMT, most deaths were associated with failure of hematopoietic reconstitution.<sup>16</sup>

Whether the source of stem cells affects the long-term DFS of AML patients can be examined only from the results of nonrandomized clinical studies, and thus, definitive information is lacking. In a recent retrospective analysis from the European Group for Blood and Marrow Transplantation (EBMT), no differences in DFS, RR, or OS were observed between AML patients undergoing autoPBSCT and autoBMT.<sup>17</sup> Similar results were recently reported in a small single-institution study nonprospectively comparing autoBMT and autoPBSCT for AML patients.<sup>18</sup> A greater number of patients in prospective randomized studies with sufficiently long follow-up will be needed to settle this issue.

In our series, engraftment was generally rapid in both groups and was similar to that in reports by other authors. However, we have observed no differences in RR between patients transplanted with PBPCs collected early after induction and/or consolidation and those patients undergoing autoPBSCT with cells collected after HDAC, a finding not observed by other groups. This may be related to the dose of Ara-C administered before PBPC collection. In our study, the Ara-C dose was 8 g/m<sup>2</sup>, lower than generally reported by others.<sup>7,8,10</sup> Thus, an increasing intensity of chemotherapy before autoPBSCT will probably have a greater impact in preventing relapses by a greater reduction of the leukemic contamination of the PBPCs and in the amount of residual disease in the patient.

Some authors have suggested that conditions in which leukemia will relapse solely from leukemic cells in the graft are rare.<sup>19</sup> Thus, a potential alternative to improve the therapeutic results in the field of intensification therapy with autologous stem cell support should be directed toward the development of less toxic and more effective conditioning regimens. As in the allogeneic setting, the 2 most commonly used types of regimens for autologous transplantation in AML involve cyclophosphamide and total body irradiation or cyclophosphamide and busulfan. Recently, encouraging results have been reported with the combination of BCNU, amsacrine, idarubicin (Vepeside), and Ara-C (BAVC) as a preparative regimen for autoBMT in patients with AML in second remission<sup>20,21</sup> or in relapse after an autoPBSCT.<sup>22</sup> These studies confirm that the BAVC combination is an effective regimen for autografting in AML and deserves further study. Finally, in this field of new preparative regimens, a more effective conditioning chemotherapy by cytokine priming and HDAC addition may have contributed to the good results observed in the series reported by Gondo et al.,<sup>11</sup> achieving a 3-year DFS of 78.6% and a very low RR of 21.4%.

With these aims, within the Spanish Cooperative Group we have designed PETHEMA, a therapeutic protocol for patients with de novo AML up to 65 years of age. In this new scheme, patients will undergo 2 courses of chemotherapy consisting of idarubicin ( $12 \text{ mg/m}^2 \times 3$ ) or daunorubicin ( $60 \text{ mg/m}^2 \times 3$ ) and Ara-C ( $200 \text{ mg/m}^2 \times 7$ ). Patients lacking an HLA-identical donor will undergo an early intensification course consisting of HDAC ( $1 \text{ g/m}^2$  per 12 hours  $\times 4$ ) and mitoxantrone ( $12 \text{ mg/m}^2 \times 3$ ) followed by PBPC collections. AutoPBSCT will be performed immediately thereafter. The conditioning regimen consists of busulfan ( $16 \text{ mg/kg}$ ), idarubicin ( $40 \text{ mg/kg}$ ), and Ara-C ( $3 \text{ g/m}^2$  per 12 hours  $\times 2$  days) plus G-CSF (days  $-9$  to  $-2$ ), similar to that reported by Gondo et al.<sup>11</sup>

In conclusion, although there is interpatient variability, PBPCs can be collected easily in AML patients after mobilization with chemotherapy, hematopoietic growth factors, or both. On the other hand, short-term hematopoietic recovery is faster than that observed after purged or unpurged autoBMT. Hence, the risks related to granulocytopenia and thrombocytopenia are decreased, making autoPBSCT a safer procedure than autoBMT. Relapse still remains the most frequent cause of treatment failure after autoPBSCT. From our point of view, the design of new clinical trials for AML, including autoPBSCT, must be directed toward an improvement in DFS, including collecting PBPCs after administration of HDAC, and in the development of new preparative regimens with greater antileukemic efficacy.

## REFERENCES

1. De la Rubia J, Sanz MA. Autologous peripheral blood stem cell transplantation for acute leukaemias. *Baillières Clin Haematol* 12:139–150, 1999.
2. Körbling M, Fliedner TM, Holle R, et al. Autologous blood stem cell (ABSCT) versus purged bone marrow transplantation (pABMT) in standard risk AML: influence of source and cell composition of the autograft on hematopoietic reconstitution and disease-free survival. *Bone Marrow Transplant* 7:343–349, 1991.
3. Reiffers J, Körbling M, Labopin M, Henon P, Gorin NC. Autologous blood stem cell transplantation versus autologous bone marrow transplantation for acute myeloid leukemia in first complete remission. *Int J Cell Cloning* 10 (Suppl 1):111–113, 1992.
4. Szer J, Juttner CA, To LB, et al. Post-remission therapy for acute myeloid leukemia with blood-derived stem cell transplantation: results of a collaborative phase II trial. *Int J Cell Cloning* 10 (Suppl 1):114–116, 1992.
5. Sanz MA, de la Rubia J, Sanz GF, et al. Busulfan plus cyclophosphamide followed by autologous blood stem cell transplantation for patients with acute myeloblastic leukemia in first complete remission: a report from a single institution. *J Clin Oncol* 11:1661–1667, 1993.
6. De la Rubia J, Sanz GF, Martin G, et al. Autologous blood stem cell transplantation (ABSCT) for acute myeloblastic leukemia in first remission: intensification therapy before

- transplant does not prolong disease-free survival. *Haematologica* 84:125–132, 1999.
7. Schiller G, Miller T, Lee M, et al. Transplantation of autologous peripheral blood progenitor cells procured after high-dose cytarabine/G-CSF-based consolidation for adults with acute myelogenous leukemia in first complete remission [abstract]. *Blood* 88:127a, 1996.
  8. Linker CA, Ries CA, Damon LE, et al. Autologous stem cell transplantation for acute myeloid leukemia in first remission [abstract]. *Blood* 90:113a, 1997.
  9. Reichle A, Hennemann B, Meidenbauer N, et al. Peripheral blood stem cell transplantation (PBSCT) during consolidation treatment of *de novo* acute myelogenous leukemia [abstract]. *Bone Marrow Transplant* 19:100a, 1997.
  10. Martin C, Torres A, Leon A, et al. Autologous peripheral blood stem cell transplantation (PBSCT) mobilized with G-CSF in AML in first complete remission: role of intensification therapy in outcome. *Bone Marrow Transplant* 21:375–382, 1998.
  11. Gondo H, Harada M, Miyamoto T, et al. Autologous peripheral blood stem cell transplantation for acute myelogenous leukemia. *Bone Marrow Transplant* 20:821–826, 1997.
  12. Kaplan EL, Meier P. Nonparametric estimation from incomplete observations. *J Am Stat Assoc* 53:457–481, 1958.
  13. Dixon WJ. BMDP Statistical Software. Berkeley, CA, University of California, 1990.
  14. Grinwade D, Walker H, Oliver F, et al. The importance of diagnostic cytogenetics on outcome in AML: analysis of 1612 patients entered into the MRC AML 10 trial. *Blood* 92:2322–2333, 1998.
  15. Pendry K, Alcorn MJ, Burnett AK. Factors influencing haematological recovery in 53 patients with acute myeloid leukaemia in first remission after autologous bone marrow transplantation. *Br J Haematol* 83:45–52, 1993.
  16. Burnett AK, Goldstone AH, Stevens R, et al. Randomized comparison of addition of autologous bone-marrow transplantation to intensive chemotherapy for acute myeloid leukaemia in first remission: results of MRC AML 10 trial. *Lancet* 351:700–708, 1998.
  17. Reiffers J, Labopin M, Sanz MA, et al. Autologous blood cell vs. marrow transplantation for acute myeloid leukemia in complete remission: an EBMT retrospective analysis. *Bone Marrow Transplant* 25:1115–1119, 2000.
  18. Visani G, Lemoli RM, Tosi P, et al. Use of peripheral blood stem cells for autologous transplantation in acute myeloid leukemia patients allows faster engraftment and equivalent disease-free survival compared with bone marrow cells. *Bone Marrow Transplant* 24:467–472, 1999.
  19. Hagenbeek A. Leukemic cell kill in autologous bone marrow transplantation: in vivo or in vitro? *Leukemia* 4:85–87, 1992.
  20. Meloni G, De Fabritiis P, Petti MC, Mandelli F. BAVC regimen and autologous bone marrow transplantation in patients with acute myelogenous leukemia in second remission. *Blood* 75:2282–2285, 1990.
  21. Meloni G, Vignetti M, Avvisati G. BAVC regimen and autograft for patients with acute myelogenous leukemia in second remission. *Bone Marrow Transplant* 18:693–698, 1996.
  22. De la Rubia J, Sanz GF, Martin G, et al. Autologous bone marrow transplantation for patients with acute myeloblastic leukemia in relapse after autologous blood stem cell transplantation. *Bone Marrow Transplant* 18:1167–1173, 1996.

# Treatment of Relapse After Autograft for Acute Leukemia in Remission

**L. Garderet, M. Labopin, L. Fouillard, F. Frassoni, N.C. Gorin,  
O. Ringden, for the Acute Leukemia Working Party  
of the European Group for Blood and Marrow Transplantation**

*Centre de Recherche Claude Bernard (L.G., M.L., L.F., N.C.G.), Centre International Greffes de Moelle, Hôpital Saint-Antoine AP-HP and EBMT Data Centre, Institut des Cordeliers, Paris, France; BMT Units (F.F.), Ospedale San Martino, Genova, Italy; Department of Clinical Immunology and Centre for Allogeneic Stem Cell Transplantation (O.R.), Huddinge Hospital, Sweden*

## ABSTRACT

**Background.** Patients with acute leukemia who relapse after treatment with high-dose chemoradiotherapy followed by an autologous stem cell transplantation are expected to have a poor prognosis. However, this has not been previously studied and it is unknown whether the prognosis of these patients can be improved. **Methods.** All patients who relapsed after undergoing autologous stem cell transplantation for acute leukemia in remission between January 1, 1981, and December 31, 1996, and who were reported to the Acute Leukemia Working Party of the European Cooperative Group for Blood and Marrow Transplantation (EBMT), were included in the study. Ninety patients underwent an allograft (group A), 2584 were treated with chemotherapy (group B), and 74 received a second autograft (group C). Risk factors for survival were analyzed in univariate and multivariate analyses. **Results.** The 2-year survival rates after relapse were  $32\% \pm 5\%$ ,  $11\% \pm 1\%$ , and  $42\% \pm 6\%$  in groups A, B, and C, respectively. In group A, those with an HLA-A-, -B-, and -DR-compatible related or unrelated donor had a 2-year survival of  $37\% \pm 7\%$  compared with  $13\% \pm 8\%$  for those receiving a graft from an HLA-mismatched donor. The following factors were associated with better survival in multivariate analyses: interval from first autograft to relapse  $>5$  months, first autograft performed later than 1991, patient age  $<26$  years, group B vs. HLA mismatches from group A, group C vs. group B, patients who were not treated with total body irradiation (TBI) at first autograft, and patients in first remission at first autograft. Patients who received a first autologous transplant with TBI did better with a second autograft than with an HLA-matched allograft. In the absence of TBI for the initial autograft, the

trend was in favor of an allograft for the second transplant. **Conclusions.** Patients with acute leukemia relapse after an autograft have a poor outcome. However, survival can be improved by a second autograft, especially if the patient received TBI in the first regimen. For patients who did not get TBI for their first autograft, an allograft should be considered.

## INTRODUCTION

Patients with high-risk acute leukemia are commonly treated with intensive chemotherapy, with or without TBI, followed by autologous stem cell transplantation. Up to half of these patients relapse, and then only a fraction can be cured.<sup>1-3</sup> The 3 treatment possibilities for these patients include allogeneic bone marrow transplantation if a suitable donor is available, a second autograft, or chemotherapy alone.<sup>4</sup> In allogeneic transplantation, the benefit of the graft-vs.-leukemia effect is impaired by high transplant-related mortality (TRM).<sup>5,6</sup> On the other hand, autografting has less TRM but an increased relapse rate.<sup>7</sup> This study was performed to evaluate these 3 treatment modalities for patients with acute leukemia in remission who relapsed after a first autograft. Survival and prognostic factors were analyzed. Finally, for patients who had a second graft, we compared the outcome after either allogeneic or autologous transplantation.

## PATIENTS AND METHODS

### Patients

All patients who relapsed after undergoing autologous stem cell transplantation for acute leukemia in remission between January 1, 1981, and December 31, 1996, and who were reported to the Acute Leukemia Working Party of the EBMT, were included in the study. Ninety patients underwent an allograft (group A), 2584 were treated with chemotherapy (group B), and 74 received a second autograft (group C). Follow-up time was a median of 35 months (range, 5–137 months) from first autograft, and time from relapse was 6 months (range, 3–136 months). Patient characteristics are summarized in Table 1. Median age was 26 years, and sex ratio was similar for the 3 groups. There were fewer patients with acute lymphoblastic leukemia (ALL) in group C compared with the other groups. There was no difference in remission status at first autograft. The first autograft was performed more recently in group A compared with groups B and C. TBI at first autograft was more commonly used in group A, and peripheral blood (PB) as a source of stem cells was more common in group C. Time from first autograft to relapse was shorter in group B compared with the other groups ( $P=.0002$ ). Time from relapse to second transplant was longer in group A vs. group C. At second transplant, a TBI-

**Table 1.** Characteristics at First Autograft in Patients Who Later Relapsed and Underwent Allogeneic Transplantation (Group A), Chemotherapy (Group B), or a Second Autograft (ABMT) (Group C)\*

	Group A	Group B	Group C	P
Patients, <i>n</i>	90	2584	74	NS
Age, y	24 (1-56)	26 (1-77)	26 (1-63)	.06†
Sex, F/M	38/52	1112/1472	30/44	NS
ALL, <i>n</i>	35	1116	18	.0012‡, .05§
AML, <i>n</i>	55	1468	56	NS
CR1, <i>n</i> (%)	71 (79)	1569 (61)	60 (81)	NS
CR2, <i>n</i>	18	842	10	NS
CR3, <i>n</i>	1	173	4	NS
Year of first autograft	1993 ('86-'96)	1991 ('81-'96)	1990 ('82-'96)	.04‡, .0001§
Conditioning				
TBI, <i>n</i> (%)	51 (66)	1169 (59)	21 (36)	.0004‡§
Bu/Cy, <i>n</i>	11	387	22	NS
Other chemotherapy, <i>n</i>	15	438	16	NS
Missing data, <i>n</i>	13	590	15	NS
Source of first ABMT graft				
Bone marrow, <i>n</i> (%)	69 (77)	2221 (86)	41 (55)	.00001‡
PBPC, <i>n</i>	14	253	32	.045†
Both, <i>n</i>	7	110	1	.0002§
Patients in CR1				
Time from diagnosis to CR1, d	41 (15-426)	44 (10-479)	41 (20-448)	NS
Time from CR1 to first autograft, d	123 (48-460)	132 (10-1960)	130 (24-417)	NS
Time from first autograft to relapse, mo	8 (0-98)	5 (0-124)	8 (1-72)	.0001†, .0017‡
Time from first autograft to second transplant, mo	13 (3-104)	—	12 (1-79)	NS
Time from relapse to second transplant, mo	5 (1-35)	—	3 (<1-56)	.0003§
TBI at second transplant, <i>n</i> (%)	21 (41%)	—	6 (11%)	.0005§
Follow-up after second transplant, mo	24 (1-128)	—	14 (1-92)	.08§

\*Data are median (range) unless otherwise indicated. NS, not significant; CR, clinical remission; TBI, total body irradiation; Bu, busulfan; Cy, cyclophosphamide; PBPC, peripheral blood progenitor cells; †A vs. B; ‡B vs. C; §A vs. C; ||among patients in CR1.

containing regimen was given more often to the allograft recipients than to the second autograft recipients ( $P=.0005$ ).

### Donors and Immunosuppression

Among the allogeneic donors, there were 26 HLA-identical siblings, 1 syngeneic donor, and 2 HLA-identical parents. HLA typing was serologic, and genomic methods were increasingly used for class II typing in more recent years. Fourteen HLA-mismatched family donors were also used. Among the unrelated donors, 33 were HLA-A-, -B-, and -DR-compatible, and 6 were mismatched. In the primary analysis, patients receiving grafts from HLA-identical related vs. HLA-compatible unrelated and mismatched donors were analyzed separately. For comparison with second autografts, only recipients of bone marrow from related HLA-identical donors and recipients of unrelated HLA-compatible bone marrow were analyzed, because of the poor outcome in the HLA mismatches. In the recipients of HLA-matched marrow, immunosuppression consisted of cyclosporine in 6, cyclosporine combined with methotrexate in 34, and T-cell depletion in 5; information was lacking in 17. In recipients of HLA-mismatched grafts, cyclosporine alone was given to 3, cyclosporine and methotrexate to 3, and T-cell depletion to 6; information was not available in 8.

### Statistical Analysis

All analyses were performed with the SPSS statistical package. Kaplan-Meier curves for TRM, relapse, leukemia-free survival (LFS), and patient survival were calculated with the product limit method according to Kaplan and Meier.<sup>8</sup> Survival and relapse were calculated from the time of relapse after the first autograft. The significance of differences between the curves was estimated by the log-rank test (Mantel-Cox). Cox multivariate regression analysis was performed in the various groups to estimate the independent effects of various potential risk factors in TRM, relapse, survival, and LFS.<sup>9</sup> All factors differing significantly among groups A, B, and C and/or prognostic factors in 1 group at the time of the first autograft were included. Factors in the multivariate analysis were group A vs. B, diagnosis of ALL vs. acute myeloid leukemia, year of transplant 1991 or earlier vs. later (median), age at the time of first autograft  $\leq 25$  vs.  $> 25$  years (median age), patient sex, complete remission (CR) status at first autograft (CR1 vs. CR2 and CR3), interval from first autograft to relapse  $\leq 8$  vs.  $> 8$  months (median), pretransplant regimen, including TBI or not, (first graft), source of stem cells (PB vs. marrow, first graft) remission status at second transplant (CR vs. no CR), and interval from relapse to second transplant (median, 5 months).



## RESULTS

### Overall Outcome

Two years after relapse following first autograft, the overall survival was  $32\% \pm 5\%$  (mean  $\pm$  95% confidence interval) in group A,  $11\% \pm 1\%$  in group B, and  $42\% \pm 6\%$  in group C (Figure 1). Five years after relapse, there were only 24 patients at risk, and survival probability in group B was only 5%. In group C, in patients from whom stem cells were collected before the first autograft, only 6 of 33 (18%) were in CR at second autograft, compared with 22 of 26 (85%) in patients from whom stem cells were reharvested before second autograft ( $P < .0001$ ). Survival at 2 years after relapse following the first autograft was  $31\% \pm 8\%$  and  $59\% \pm 10\%$  in the 2 groups, respectively ( $P = .03$ ).

### Outcome in Recipients of Allograft According to HLA Matching

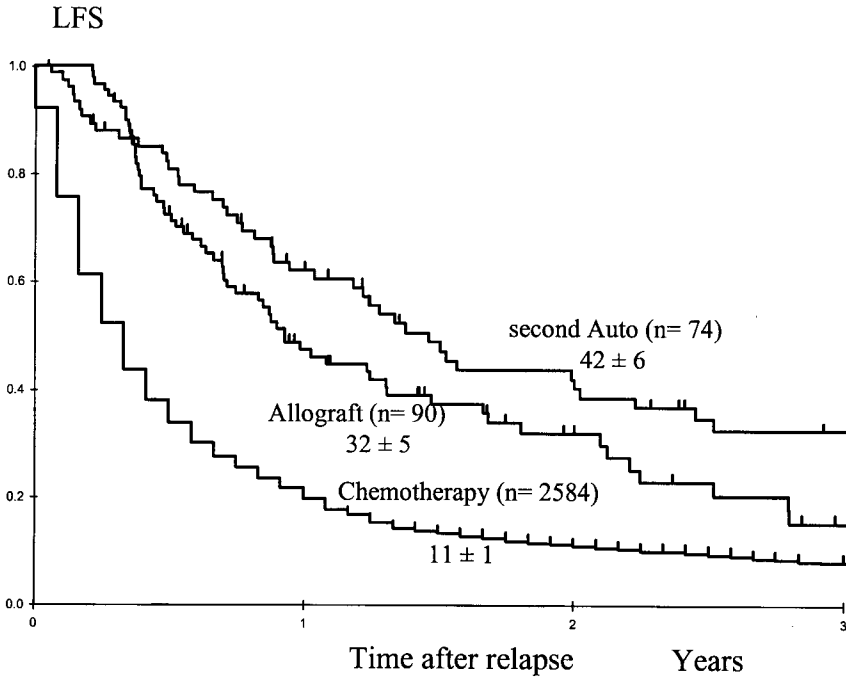
LFS was decreased in patients receiving HLA-mismatched marrow ( $P = .03$ ) (Figure 2). In group A, those receiving a graft from an HLA-compatible related or unrelated donor had a 2-year probability of survival of  $37\% \pm 7\%$  vs.  $13\% \pm 8\%$  for those receiving HLA-mismatched marrow. The probability of grades II–IV acute GVHD was  $56\% \pm 9\%$  in recipients of HLA-identical related bone marrow ( $n = 29$ ), compared with  $53\% \pm 10\%$  in recipients of marrow from HLA-compatible unrelated donors ( $n = 33$ ). In recipients of marrow from HLA-mismatched related or unrelated bone marrow ( $n = 20$ ), the cumulative incidence of acute GVHD was  $24\% \pm 9\%$ .

### Causes of Death

Recurrent leukemia was the most common cause of death in all patients, especially in groups B and C (Table 2). Other common causes of death were infections, including interstitial pneumonitis and toxicity, especially in group A.

### Multivariate Analysis of Outcome

Factors associated with a better survival in multivariate analyses included group C vs. group B, younger age, CR1 vs. CR2 or CR3, no TBI during conditioning before first autograft, and most of all, a longer interval from first autograft to relapse ( $>5$  months) (Table 3). There was no difference between patients who received an allograft from an HLA-compatible donor and patients who received only chemotherapy, but an allograft from a mismatched donor was associated with a lower survival compared with chemotherapy. In addition, results were significantly improved for patients who received the first autograft after 1991.



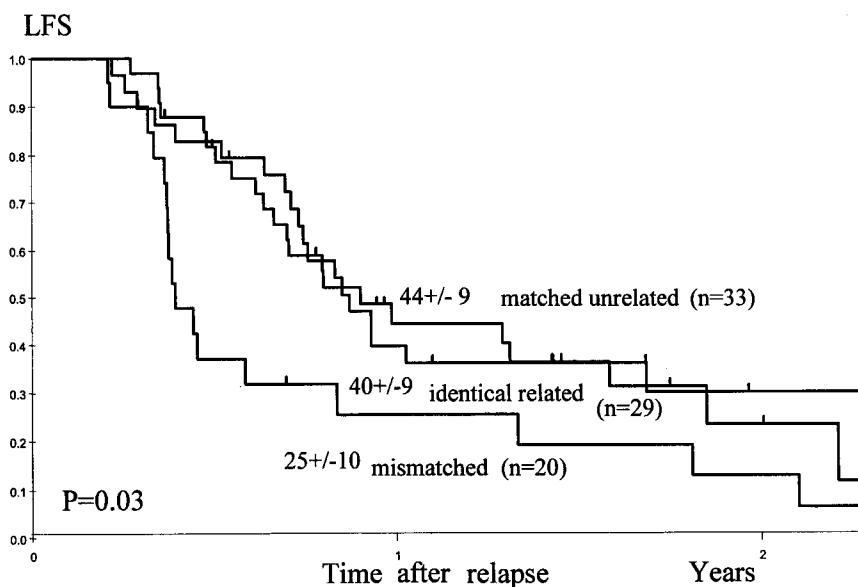
**Figure 1.** Leukemia-free survival (LFS) in patients with acute leukemia who relapsed after autograft and thereafter were treated with an allograft ( $n=90$ ) (group A), chemotherapy ( $n=2584$ ) (group B) or a second autograft (Auto) ( $n=74$ ) (group C).

### Comparison of Allografts From an HLA-Matched Donor and Second Autografts

Allograft was associated with a higher TRM (51% vs. 26%), but the relapse incidence tended to be lower (44% vs. 53%). At the end, we did not find significant differences in terms of disease-free survival (27% for allograft and 35% for second autograft). In the multivariate analyses, the 3 factors associated with a lower LFS and overall survival were older age, TBI at first autograft, and early relapse (<8 months after first autograft). Moreover, an interaction was identified between the use or not of TBI at first transplant and the type of the second transplant.

### Outcome in Relation to TBI

In patients receiving TBI at the first autograft, LFS was significantly better in those undergoing a second autograft than for those receiving an HLA-matched allograft (Figure 3). Ten of the patients in groups A and C were conditioned twice



**Figure 2.** Leukemia-free survival (LFS) in recipients who received an allograft after relapse following autologous bone marrow transplantation. Outcome according to HLA matching.

with TBI. Patients not treated with TBI at first autograft tended to have a better LFS in group A vs. group C ( $P=.08$ ) (Figure 4).

## DISCUSSION

Patients with acute leukemia and recurrent disease after an autograft have a very poor outcome. Only 5% of those treated with chemotherapy alone were alive at 5 years (O. Ringden, M. Labopin, N.C. Gorin, unpublished data). To change this dismal outcome, we retrospectively studied alternative treatment such as second autograft or allograft. Patients undergoing a second autograft had significantly better survival rates than those treated with chemotherapy alone. This indicates that a more active approach is worthwhile. There was also a close correlation between remission at second autograft and reharvest ( $P=.0001$ ). In contrast, patients who were not in remission at second autograft more often received a graft that was collected before first autograft. Therefore, patients who received autografts harvested before first autograft had a worse outcome. In the study of patients treated with allografts, those receiving HLA-mismatched related or unrelated bone marrow had a high TRM and a low LFS, compared with those receiving HLA-matched related or unrelated bone marrow. This is in accordance with previous studies.<sup>10</sup> The poorer outcome with

**Table 2.** Causes of Death After Relapse Following Autograft for Acute Leukemia\*

	Group A	Group B	Group C
Recurrent leukemia	12 (19)	1453 (71)	30 (64)
Interstitial pneumonitis	9 (15)	33 (2)	4 (8.5)
Other infections	10 (16)	241 (12)	1 (2)
Toxicity, organ failure, VOD	10 (16)	18 (1)	4 (8.5)
Graft-vs.-host disease	5 (8)	—	—
Hemorrhage	4 (7)	19 (1)	—
Graft failure, rejection	2 (3)	3	—
Other, transplant-related	10 (16)	21 (1)	—
Other, not transplant-related	—	—	1 (2)
New malignancy	—	1	—
Missing data	—	257 (12)	7 (15)
Total	62	2046	47

\*Data are n (%) or n. VOD, veno-occlusive disease of the liver.

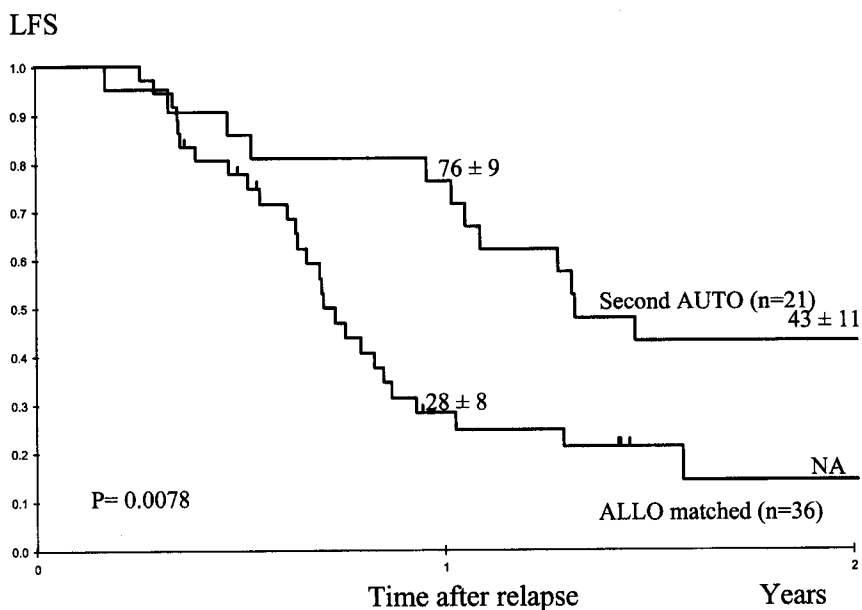
HLA-mismatched transplants is generally due to an increased risk of severe GVHD. This is not the case in our study, where the risk of GVHD was decreased in HLA-mismatched recipients, maybe because 30% of them were T-cell depleted.

Recurrent leukemia was the most common cause of death in all 3 groups (Table 2). In group A, recurrent leukemia was less common than in the other 2 groups. In contrast, procedure-related complications such as infections and toxicity were common causes of death in the allograft recipients.

**Table 3.** Significant Prognostic Factors by Multivariate Analysis Using the Date of Relapse as the Starting Point and Alive or Dead as the End Point\*

Results (Survival After Relapse)	P	RR (95% CI)
Interval from transplant to relapse >5 mo	<.00001	0.6 (0.54–0.66)
Year of transplant later than 1991	<.00001	0.77 (0.68–0.85)
Median age >26 y	.0017	1.18 (1.06–1.31)
Treatment for relapse		
HLA-matched allograft vs. group B	NS	—
HLA-mismatched allograft vs. group B	.0022	2.46 (1.38–4.37)
Group C vs. group B	.0048	0.62 (0.44–0.86)
TBI vs. no TBI	.015	1.13 (1.03–1.25)
CR1 vs. CR2+	.02	0.88 (0.79–0.98)

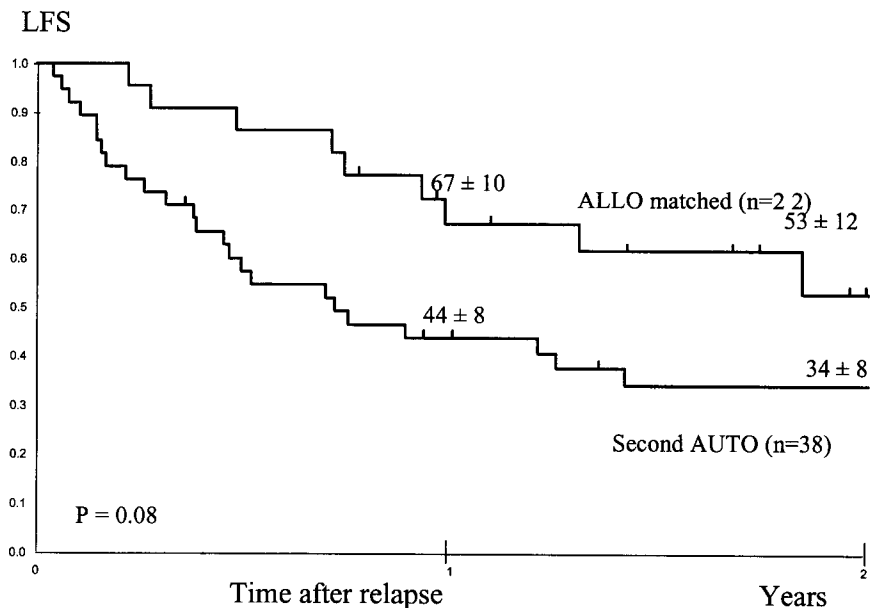
\*Patients included in multivariate analysis, n=1876; group A HLA-matched allograft, n=47; group A HLA-mismatched allograft, n=14; group B, n=1761; group C, n=54. CI, confidence interval; CR, complete remission; RR, relative risk; TBI, total body irradiation.



**Figure 3.** Leukemia-free survival (LFS) in patients who received total body irradiation at first autograft and subsequently received a second autograft (AUTO) or an HLA-matched related or unrelated allograft (ALLO). %  $\pm$  95% confidence interval 1 and 2 years after relapse. NA, not assessable.

The most important risk factor was a long interval from first transplant to relapse. Those with an early relapse have a highly resistant cell clone with a high probability of subsequent relapse. Patients who had their first transplant after 1991 had an improved survival after relapse, possibly related to improvements in patient management. This may include the use of granulocyte colony-stimulating factor (G-CSF), better infection control, and perhaps more effective chemotherapy.<sup>1-11</sup> Younger patients had a better survival and LFS, in accordance with previous studies in patients undergoing primary allograft.<sup>12</sup> Young patients tolerated the conditioning better and ran less risk of TRM, especially in those undergoing 2 subsequent procedures with heavy myeloablative therapy.

TBI was an important risk factor, and patients treated with TBI at first autograft had a poor outcome, especially if they underwent a subsequent allotransplant (Figures 3 and 4). To explain this, several factors must be taken into consideration. In univariate analyses, TBI was a risk factor for TRM and relapse in patients treated with a subsequent allograft, but not a second autograft. The higher TRM may be affected by the high death rate, 6 of 7, in group A patients receiving 2 rounds of TBI, so that probably should be avoided. The higher relapse rate in the TBI group



**Figure 4.** Leukemia-free survival (LFS) in patients not treated with total body irradiation at first autograft who subsequently received a second autograft (AUTO) or HLA-identical related or unrelated bone marrow (ALLO matched). %  $\pm$  95% confidence interval is given at 1 and 2 years after relapse of first autograft.

may also be due to the fact that this is a selected group of patients with therapy-resistant leukemic cell clones. Some of these patients had ALL, and busulfan may be inferior at a second transplant procedure, as was found in primary autografts.<sup>13</sup>

The risk factors found in this study may provide a guide to decision-making for treatment of patients with acute leukemia who relapse after autografting. A second transplant procedure should be tried in young patients who relapse >8 months after autografting. If TBI was used at first autograft, a second autograft may be favored. If TBI was not used, a matched allograft should be considered.

## REFERENCES

1. Burnett A, Eden O. The treatment of acute leukemia. *Lancet* 349:270-275, 1997.
2. Gorin NC. Autologous stem cell transplantation in acute myelocytic leukemia. *Blood* 92:1073-1090, 1998.
3. Rowe JM, Ciobanu N, Ascensao J. Recommended guidelines for the management of autologous and allogeneic bone marrow transplantation. *Ann Intern Med* 120:143-158, 1994.
4. Zittoun R, Mandelli F, Willemze R. Autologous or allogeneic bone marrow transplanta-

- tion compared with intensive chemotherapy in acute myelogenous leukemia. *N Engl J Med* 332:217–223, 1995.
5. Weiden PL, Fluornoy N, Thomas ED. Anti-leukemic effect of graft-versus-host disease in human recipients of allogeneic marrow grafts. *N Engl J Med* 300:1068–1073, 1979.
  6. Horowitz MM. Graft-versus-leukemia reactions following bone marrow transplantation in humans. *Blood* 75:555–562, 1989.
  7. Brenner MK, Rill DR, Moen RC. Gene-marking to trace origin of relapse after autologous bone-marrow transplantation. *Lancet* 341:85–86, 1993.
  8. Kaplan EL, Meier P. Nonparametric estimation from incomplete observations. *J Am Stat Assoc* 53:457–481, 1958.
  9. Cox DR. Regression models and life-tables. *J R Stat Soc (Series B)* 34:187–220, 1972.
  10. Beatty PG, Clift RA, Mickelson EM. Marrow transplantation from related donors other than HLA identical siblings. *N Engl J Med* 313:765–771, 1985.
  11. Vose JM, Armitage JO. Clinical applications of hematopoietic growth factors. *J Clin Oncol* 13:1023–1035, 1995.
  12. Barrett AJ, Horowitz MM, Pollock BH. Bone marrow transplants for acute lymphoblastic leukemia: factors affecting relapse and survival. *Blood* 74:862–871, 1989.
  13. Ringden O, Labopin M, Tura S, for the Acute Leukemia Working Party of The European Group for Blood and Marrow Transplantation (EBMT). A comparison of busulphan versus total body irradiation combined with cyclophosphamide as conditioning for autograft or allograft bone marrow transplantation in patients with acute leukemia. *Br J Haematol* 93:637–645, 1996.

# Interleukin-2 After Autologous Stem Cell Transplantation for Acute Myelogenous Leukemia in First Complete Remission: The City of Hope Experience

**Anthony S. Stein, Margaret R. O'Donnell, Marilyn S. Slovak, Irena Sniecinski, Doni Woo, Jacqueline Hilger, Andrew Dagens, Nayana Vora, Daniel Arber, Stephen J. Forman**

*Division of Hematology and Bone Marrow Transplantation (A.S.S., M.R.O., D.W., S.J.F.), Department of Cytogenetics (M.S.S.), Department of Transfusion Medicine (I.S.), Department of Information Sciences (J.H., A.D.), Department of Radiation Oncology (N.V.), Department of Anatomic Pathology (D.A.), City of Hope National Medical Center, Duarte, California*

## ABSTRACT

Despite improvement in the proportion of patients achieving durable remission with dose-intensive consolidation strategies, leukemic relapse still occurs in 40%–70% of patients who achieve an initial remission. Initial reports using peripheral blood stem cells (PBSCs) for autologous stem cell transplantation (autoSCT) for acute myeloid leukemia (AML) in first remission reported improved engraftment, but relapse rates of 57%–60% were nonetheless observed. Interleukin (IL)-2, a cytokine that has a broad range of antitumor effects, has been used in some patients undergoing autologous transplant for a variety of malignancies. We report a phase 2 study of IL-2 (Chiron) after high-dose cytosine arabinoside (Ara-C)-mobilized autoSCT in 70 patients in first complete remission (CR) treated between August 1994 and November 1999. Treatment strategy consisted of (1) consolidation after induction with high-dose Ara-C with or without idarubicin followed by autologous PBSC collection; (2) autoSCT using fractionated total body irradiation (fTBI) 12 Gy, VP-16 60 mg/kg, and cyclophosphamide (Cytoxan) 75 mg/kg; and (3) IL-2 upon hematologic recovery after autoSCT. The IL-2 schedule was  $9 \times 10^6$  U/m<sup>2</sup> per 24 hours on days 1–4 and  $1.6 \times 10^6$  U/m<sup>2</sup> per 24 hours on days 9–18. Seventy patients with the following characteristics were entered on the study. Median age 45 years (range, 21–61 years), cytogenetics favorable ( $n = 17$ ; 24%) [t(8;21), inv(16)], intermediate ( $n = 30$ ; 43%) [normal, +8, -Y], unfavorable ( $n = 8$ ; 11%) [complex, t(9;11), t(3;5), t(6;9)], and unknown ( $n = 15$ ; 21%). Sixty patients underwent autoSCT a median of 4 months after complete remission. There was



1 septic death during neutropenia in consolidation and 1 during neutropenia after transplant, for an overall mortality in the program of 3%. Forty-nine of 60 patients were able to receive posttransplant IL-2 at a median of 5 weeks (range, 3–11 weeks) after transplant. With a median follow-up of 3.5 years (range, 0.8–5.8 years), the 3-year probability of survival for all 70 patients is 73% (95% confidence interval [CI], 62%–84%) and 75% (95% CI, 62%–86%) for the 60 patients undergoing autoSCT. The 3-year disease-free survival (DFS) rates for favorable, intermediate, and unfavorable cytogenetics were 88%, 65%, and 63%, respectively. Toxicities from IL-2 were mainly thrombocytopenia, leukopenia, fever, and fluid retention. No patient required intensive care or ventilatory support. These results suggest that high-dose IL-2 after high-dose Ara-C–mobilized autoSCT is associated with a very low regimen-related mortality and may improve DFS.

## INTRODUCTION

Since the mid-1970s, interest in autologous cell transplantation for AML has increased substantially in transplant centers around the world. This increase has been due in part to the limited success of standard-dose chemotherapy in achieving long-term disease-free survival for the vast majority of adults with AML. New techniques for hematopoietic cell procurement, combined with the expanded knowledge of the cellular and molecular biology of AML, have allowed refinements in the interpretation of clinical results for AML in trials using either chemotherapy or autologous hematopoietic cell transplantation.

Studies using unpurged marrow, purged marrow, or peripheral blood stem cells have reported disease-free survival for patients transplanted in first CR of between 34% and 70%.<sup>1–6</sup> Although each trial demonstrates the potential efficacy of the approach chosen, many of the studies have been criticized for including patients who had received widely varying induction therapies, types and numbers of consolidation cycles before autologous transplant, duration of CR before transplant, and relatively short follow-up times as well as differences in stem cell product manipulation and preparative regimens.

Unlike allogeneic transplantation for AML in first remission, where the major causes of failure are complications of the therapy, the major cause of failure after autologous transplant is leukemic relapse. Twin transplants and cell-marking studies have documented that the source of relapse after autologous transplant is related to the residual body burden of disease and/or to the infusion of leukemic cells contained in the stem cell graft.<sup>7,8</sup> These observations support the concept that an immunotherapeutic effect of the allograft contributes to prevention of relapse after an allogeneic transplant (graft-vs.-tumor effect).<sup>9</sup>

IL-2 is a cytokine that has antitumor activity in selected tumors. Based on data suggesting that the activation of natural killer (NK) and/or cytotoxic

T lymphocytes is also active against leukemia and lymphoma cells, IL-2-based therapies have also been under active investigation for hematologic malignancies. IL-2 has been administered to patients following recovery from autologous transplant in an effort to reproduce the graft-vs.-malignancy effect seen in allogeneic transplant.<sup>10</sup> A graft-vs.-host-like clinical phenomenon has also been reported in patients receiving IL-2 following autologous bone marrow or stem cell transplant as well as in patients treated with combinations of low-dose CsA with or without interferon.<sup>11</sup>

Several centers have explored the use of IL-2 either as part of a marrow-purging approach with *in vitro* incubation of the graft with IL-2, concomitant with administration of IL-2 in the early posttransplant phase, or as consolidation therapy following hematologic recovery.<sup>12,13</sup> Robinson et al.<sup>14</sup> reported on 22 patients with acute leukemia in relapse or beyond first remission who underwent autologous bone marrow transplantation (BMT) or peripheral blood stem cell transplant using cells that were harvested during first CR. IL-2 was given by continuous intravenous infusion after hematologic recovery at doses ranging from 9 to 12 million U/m<sup>2</sup> per day for 4–5 days followed 1 week later by a 10-day infusion of 1.6 million U/m<sup>2</sup> per day. Among 17 patients with AML, 4 remained in continuous remission 12–25 months after therapy, and 4 of 5 ALL patients were also in remission 15–25 months after therapy.

Based on the laboratory studies indicating induction of effector cells that have the capacity for lysing autologous tumor cells and the clinical trials indicating a potential therapeutic effect in patients undergoing autologous transplant for relapsed disease, we have explored the feasibility of administering posttransplant IL-2 in patients undergoing autologous transplant following high-dose Ara-C consolidation and mobilization of stem cells who were then treated with a radiation-based transplant regimen. The goals of this study were to determine the feasibility, toxicity, and therapeutic effect of a treatment program that began with consolidation therapy of AML in first remission.

## MATERIALS AND METHODS

### Patient Characteristics

Between August 1994 and November 1999, 70 patients with AML in first remission were entered onto the study. The median age of this adult population was 45 years (range, 21–61 years). The white blood cell count (WBC) at diagnosis ranged from 1000 to 295,000/ $\mu$ L, with a median of 17,000/ $\mu$ L. French-American-British (FAB) classification showed the following subtypes: M0, 5; M1, 14; M2, 19; M4, 10; M4eo, 7; M5, 8; M6, 1. A FAB type could not be assigned in 6 patients. No patients with FAB M3 were included in this study. Cytogenetic data were

classified as per Southwest Oncology Group (SWOG) criteria and are listed in Table 1. The median time from achievement of CR to entry on study was 5 weeks (range, 1–50 weeks).

### Treatment Program

Patients with AML in first CR were treated with consolidation therapy using a regimen of high-dose Ara-C with or without idarubicin. Fifty-eight patients received Ara-C 3 g/m<sup>2</sup> over 3 hours for 8 doses and idarubicin 12 mg/m<sup>2</sup> given after doses 1, 3, and 5 of Ara-C. Twelve patients who received prior consolidation were given a course of high-dose Ara-C as per Cancer and Leukemia Group B (CALGB) schedule followed by granulocyte colony-stimulating factor (G-CSF) 5 µg/kg until completion of stem cell collection. A target cell dose of 2×10<sup>6</sup> CD34<sup>+</sup> cells/kg was collected.

Following collection of stem cells, patients underwent autologous transplant using a preparative regimen of fTBI (1200 rad in 10 fractions), VP-16 60 mg/kg on day -4, and cyclophosphamide 75 mg/kg on day -2.<sup>15</sup> All patients received an unpurged stem cell product on day 0.

After stem cell reinfusion, G-CSF was given at 10 µg/kg until the absolute neutrophil count (ANC) was >500/µL for 3 days. Following clinical and hematopoietic recovery (WBC >1000 and platelets >20,000 with 1 platelet transfusion/day for 3 days), IL-2 was administered in the following schedule: 9×10<sup>6</sup> U/m<sup>2</sup> for 24 hours on days 1–4 as an inpatient and 1.6×10<sup>6</sup> U/m<sup>2</sup> for 24 hours on days 9–18 by infusion pump as an outpatient.

**Table 1.** Patient Characteristics

N	70
Cytogenetics	
Favorable	17 (24%)
inv16, t(16;16)	11
t(8;21)	6
Intermediate	30 (43%)
Normal	26
-Y	1
+8	3
Unfavorable	8 (11%)
Complex ≥3	4
11q abn	1
3q abn	2
t(6;9)	1
Unknown	15 (22%)

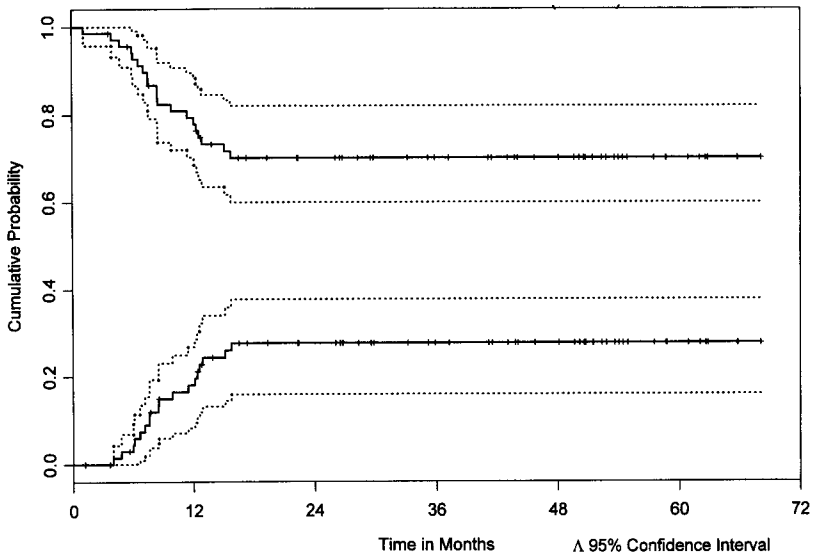
## RESULTS

Of the 70 patients entered on study, 60 underwent autologous stem cell transplantation a median of 4 months (range, 2.5–10.2 months) after achieving hematologic remission. The reasons for 10 patients failing to proceed to autoBMT from consolidation were toxicity (5), inadequate stem cell collection (4), including 1 septic death during consolidation, and 1 refusal of autoSCT.

Hematopoietic recovery to ANC 1000/ $\mu$ L and platelets 20,000/ $\mu$ L after autologous stem cell transplantation was 11 days (range, 8–58 days) and 20 days (range, 7–183 days), respectively. There was 1 septic death during neutropenia following BMT, for an overall mortality of 2 of 70 (3%); 49 of 60 patients (82%) were able to receive post-autoSCT IL-2 at a median of 4.9 weeks (range, 3.1–10.7 weeks) following autologous stem cell transplant. Currently, with a median follow-up of 3.5 years (range, 0.8–5.8 years), the 3-year DFS probability for all 70 patients is 73% (95% CI, 62%–84%) and 75% (95% CI, 62%–86%) for the 60 patients undergoing autoSCT (Figures 1 and 2). The 3-year disease-free survival probabilities for all 70 patients for favorable, intermediate, and unfavorable cytogenetics were 88%, 65%, and 63%, respectively. Toxicities from the IL-2 were mainly thrombocytopenia, leukopenia, fluid retention, and fever, which resolved with discontinuation of IL-2. No patient required intensive care or ventilatory support.

## DISCUSSION

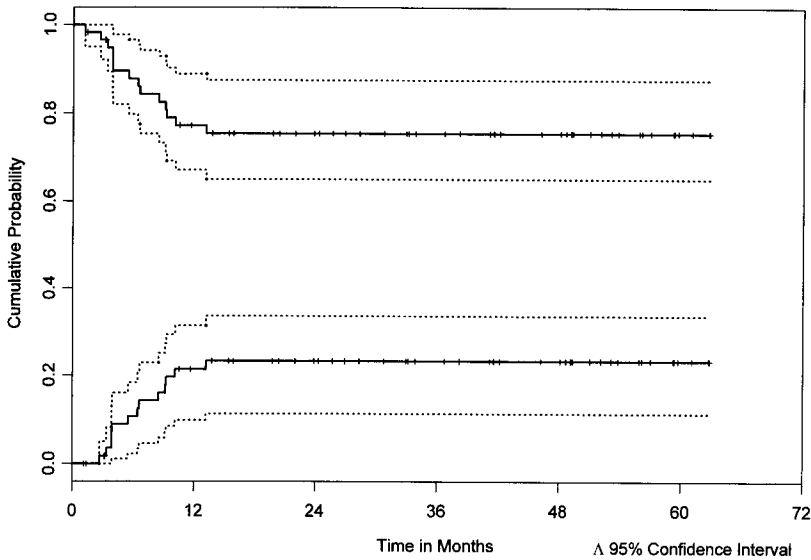
Relapse is still the major cause of failure after autologous transplantation for leukemia. Several studies, including our own pilot trials in a most recent report of the UK Medical Research Council (MRC) trial, have demonstrated that the major cause of failure after autologous transplant is related to relapse in all cytogenetic risk groups.<sup>15,16</sup> Because relapses after autologous transplants tend to occur within the first year, and IL-2-responsive lymphocytes have been detected in the circulation within 2 or 3 weeks after transplantation of autologous marrow or peripheral blood stem cells, IL-2 has been administered early after the patients have recovered from transplant-related toxicities, at a time when the tumor burden is still minimal. Several phase 1 studies have identified the maximum tolerated dose of IL-2 that can be administered after autologous transplant and have documented that these doses have immunostimulomodulatory effects.<sup>17,18</sup> We therefore conducted this study to determine the feasibility of giving high-dose IL-2 after a radiation-based transplant regimen early after transplant, and we have observed tolerable toxicities and encouraging DFS for such patients. Patients



**Figure 1.** Disease-free survival and time to relapse for intent-to-treat with autologous stem cell transplantation ( $n = 70$ ).

usually exhibit transient early lymphopenia followed by a rebound of lymphocytosis after stopping IL-2, something that was also observed in our own patient population. This rise reflects an increase in the number of cells expressing CD8<sup>+</sup> T-cells and CD16<sup>+</sup> and CD56<sup>+</sup> activated NK cells and was concomitant with enhanced cytotoxicity for in vitro tumor targets.

In our previous studies with autologous transplants using marrow, the DFS was 49% for patients on the intent-to-treat analysis and 61% for those patients who actually underwent transplantation.<sup>15</sup> Disease-free survival in that study was not correlated with cytogenetic results with the leukemia at the time of diagnosis. Patients who required 2 courses of induction therapy had an inferior outcome to those requiring 1 induction therapy to achieve a complete remission. To try to improve the efficacy of the autologous transplant procedure, several modifications were made in the protocol. The first was the addition of idarubicin to high-dose Ara-C consolidation. Most patients on the study reported here underwent consolidation with Ara-C and idarubicin in an attempt to provide better in vivo purging before the collection of peripheral blood stem cells. Although some investigators hypothesized that peripheral blood stem cells have a higher relapse rate than marrow, this was not seen in our study, as is consistent with observations from other studies.<sup>19</sup> One of the issues in the study was the feasibility of collecting an



**Figure 2.** Disease-free survival and time to relapse for autologous stem cell transplantation patients with acute myeloid leukemia ( $n = 60$ ).

adequate number of stem cells in patients who underwent consolidation of this intensity. Approximately 50% of the patients had also received induction chemotherapy with high-dose Ara-C. The fact that most patients could undergo collection of stem cells suggests that this is a feasible way of reducing the tumor burden in a patient who is undergoing stem cell collection in preparation for autologous transplant.

Once patients had completed cell collection, they were given an autologous stem cell transplant regimen using TBI, VP-16, and cyclophosphamide, the program we have used in our previous study that is tolerable for patients up to their early 60s. Most patients undergoing autologous stem cell transplant in centers around the world received a regimen of busulfan and cyclophosphamide.<sup>1</sup> Whether there are benefits to a radiation-based regimen over those using only chemotherapy cannot be assessed from this study.

As noted in the RESULTS section, the recovery rate after hematopoietic cell transplantation was relatively short, with good recovery of neutrophils and adequate recovery of platelets. The delay in platelet recovery (to  $>50,000/\mu\text{L}$ ) reflects the thrombocytopenic effect of IL-2 given early after the transplant regimen. Nevertheless, no patient had graft failure as a consequence, and all have achieved hematopoietic recovery.

One of the major questions addressed in this pilot study was whether it would be possible to administer doses of IL-2 that have been reported to induce NK cell activity early after transplant at a time when the disease burden was at a minimum posttherapy. The use of IL-2 is designed to treat not only the residual body burden of tumor not addressed by the preparative regimen but also the leukemia cells that may have been reinfused with the stem cell graft. This study shows that with proper use of supportive care, it is possible to administer IL-2 in these doses early after recovery from transplantation with minimal toxicity to the patient. As described above, no patient required admission to the intensive care unit, and none suffered respiratory failure as a consequence, despite fever and fluid accumulation, well-recognized side effects of IL-2.

This study was also designed to assess incidence of relapse before autologous transplant, the number of patients unable to undergo adequate collection of peripheral blood stem cells, and toxicities during consolidation that preclude proceeding to autologous transplant. In this trial, 85% of patients who were entered on the protocol were able to proceed to transplant, the most common cause of not proceeding being failure to collect an adequate number of cells.

In summary, this pilot study indicates that it is feasible to use high-dose IL-2 following a radiation-based autologous transplant program and that a program of intensive consolidation, stem cell collection, transplant, and IL-2 may improve disease-free survival for patients with AML in first remission undergoing transplantation. Further studies with larger numbers of patients will help determine the efficacy of this transplant approach and the role of IL-2 in curing patients with AML.

## ACKNOWLEDGMENTS

This study was supported in part by U.S. Public Service Grants NCI PPG CA 30206 and NCI CA 33572. The authors acknowledge the dedication of nurses at the City of Hope for the care of patients on this study, the staff of Information Sciences for data management and analysis, and Diana Garcia and Gwen Jorgensen for secretarial support. We also thank Doni Woo and Trudy Trimmer for their assistance in data collection.

## REFERENCES

1. Stein AS, Forman SJ. Autologous hematopoietic cell transplantation for acute myeloid leukemia. In: Forman SJ, Blume KG, Thomas ED, eds. *Hematopoietic Cell Transplantation*, 2nd ed. London, UK: Blackwell Science, 1998, p. 963–977.
2. Ball ED, Mills LE, Cornwell GG III, et al. Autologous bone marrow transplantation for

- acute myeloid leukemia using monoclonal antibody-purged bone marrow. *Blood* 75: 1199–1206, 1990.
3. Cassileth PA, Andersen J, Lazarus HM, et al. Autologous bone marrow transplant in acute myeloid leukemia in first remission. *J Clin Oncol* 11: 314–319, 1993.
  4. Löwenberg B, Verdonck LJ, Dekker AW, et al. Autologous bone marrow transplantation in acute myeloid leukemia in first remission: results of a Dutch prospective study. *J Clin Oncol* 8:287–294, 1990.
  5. Burnett AK, Pendry K, Rawlinson PM, et al. Autograft to eliminate minimal residual disease in AML in first remission: update on the Glasgow experience. *Bone Marrow Transplant* 6:59–60, 1990.
  6. Gorin NC, Aegerter P, Auvert B, et al. Autologous bone marrow transplantation for acute myelocytic leukemia in first remission: a European survey of the role of marrow purging. *Blood* 75:606–614, 1990.
  7. Brenner MK, Rill DR, Moen RC, et al. Gene-marking to trace origin of relapse after autologous bone-marrow transplantation. *Lancet* 341:85–86, 1993.
  8. Gale RP, Horowitz MM, Ash RC, et al. Identical-twin bone marrow transplants for leukemia. *Ann Intern Med* 120:646–652, 1994.
  9. Fefer A: Graft-versus-tumor responses. In: Forman SJ, Blume KG, Thomas ED, Eds. *Hematopoietic Cell Transplantation*, 2nd ed. London: Blackwell Science, 1998, p. 316–326.
  10. Weisdorf DJ, Anderson PM, Kersey JH, Ramsay NKC. Interleukin-2 therapy immediately after autologous marrow transplantation: toxicity, T cell activation and engraftment [abstract]. *Blood* 78:226, 1991.
  11. Giralt S, Weber D, Colome M, et al. Phase I trial of cyclosporine-induced autologous graft-versus-host disease in patients with multiple myeloma undergoing high-dose chemotherapy with autologous stem-cell rescue. *J Clin Oncol* 15:667–673, 1997.
  12. Margolin KA, Wright C, Forman SJ. Autologous bone marrow purging by in situ IL-2 activation of endogenous killer cells. *Leukemia* 11:723–728, 1997.
  13. Klingemann HG, Eaves CJ, Barnett MJ, et al. Transplantation of patients with high risk acute myeloid leukemia in first remission with autologous marrow cultured in interleukin-2 followed by interleukin-2 administration. *Bone Marrow Transplant* 14:389–396, 1994.
  14. Robinson N, Benyunes MC, Thompson JA, et al. Interleukin-2 after autologous stem cell transplantation for hematologic malignancy: a phase I/II study. *Bone Marrow Transplant* 19:435–442, 1997.
  15. Stein AS, O'Donnell MR, Chai A, et al. In vivo purging with high-dose cytarabine followed by high-dose chemoradiotherapy and reinfusion of unpurged bone marrow for adult acute myelogenous leukemia in first complete remission. *J Clin Oncol* 14:2206–2216, 1996.
  16. Burnett AK, Goldstone AH, Stevens RM, et al. Randomized comparison of addition of autologous bone-marrow transplantation to intensive chemotherapy for acute myeloid leukaemia in first remission: results of MRC AML 10 trial. *Lancet* 351:700–708, 1998.
  17. Foa R. Does interleukin-2 have a role in the management of acute leukemia? *J Clin Oncol* 11: 1817–1825, 1993.



18. Sznol M, Parkinson DR. Interleukin-2 in therapy of hematologic malignancies. *Blood* 83:2020–2022, 1994.
19. Reiffers J, Labopin M, Sanz M, et al. The source of stem cells does not affect the outcome of patients undergoing autologous stem cell transplantation for acute myeloid leukemia in first remission [abstract]. *Blood* 88:684a, 1996.



# **CHAPTER 11**

## **MULTIPLE MYELOMA**



# Novel Biologically Based Therapies for Multiple Myeloma

**Kenneth C. Anderson**

*Department of Adult Oncology, Dana-Farber Cancer Institute,  
Harvard Medical School, Boston, MA*

## ABSTRACT

Multiple myeloma (MM) remains incurable even with high-dose therapy and stem cell transplantation, and we are developing biologically based therapies to improve outcomes. First, myeloma cells specifically adhere to extracellular matrix (ECM) proteins and bone marrow stromal cells (BMSCs), localizing them in the BM and conferring resistance to apoptosis; agents that block adhesion restore sensitivity to treatment. Second, adherence of MM cells to BMSCs upregulates nuclear factor  $\kappa$ B (NF $\kappa$ B)-dependent interleukin (IL)-6 transcription and secretion within BMSCs, promoting growth and survival of MM cells. Protease inhibitors not only induce apoptosis of tumor cells, they also inhibit activation of NF $\kappa$ B and upregulation of IL-6 in BMSCs triggered by tumor cell adhesion. Third, proliferation of MM cells triggered by IL-6 is mediated via the mitogen-activated protein kinase (MAPK) cascade, dexamethasone-induced apoptosis is mediated via activation of related activated focal adhesion kinase (FAK), and the protective effect of IL-6 against dexamethasone-induced MM cell apoptosis is mediated via SH2-containing protein tyrosine phosphatase (SHP2 phosphatase). Delineation of these pathways will help us derive treatment strategies for triggering apoptosis, overcoming dexamethasone resistance, and inhibiting survival signals. Fourth, adhesion of MM cells to BMSCs also upregulates vascular endothelial growth factor (VEGF) secretion; VEGF triggers MAPK activation and proliferation in MM cells, and VEGF receptor inhibitors block MM cell proliferation, suggesting their potential clinical utility. Finally, in addition to antiangiogenic effects, thalidomide and its potent analogs (immunomodulatory drugs [IMiDs]) induce apoptosis or G<sub>1</sub> growth arrest in MM cells resistant to conventional therapy, providing the framework for a new treatment paradigm to target both the MM cell and the microenvironment, overcome classic drug resistance, and achieve improved outcome.

A second translational research program is based on enhancing allogeneic and autologous anti-MM immunity to improve the outcome of high-dose therapy and stem cell transplantation. Basic laboratory studies derive treatment protocols, and conversely, mechanistic evaluation of immune responses observed in patients on clinical trials identifies immune effector cells and novel target antigens. Donor lymphocyte infusions (DLIs) given to treat relapsed MM after allografting can mediate the graft-vs.-myeloma (GVM) effect that manifests as clinical responses; evaluation of these responses has permitted identification of both clonal T cells mediating GVM and their target antigens. The ultimate goal is to generate antigen-specific donor T cells to treat minimal residual disease (MRD) after allografting. Finally, multiple strategies to generate autologous anti-MM immunity form the basis for novel vaccination and adoptive immunotherapy protocols to treat MRD after autografting. These will target either patient-specific (idiotype) or shared (Muc-1 and the catalytic subunit of telomerase) antigens, or whole tumor cells (CD40-activated MM cells or fusions of MM cells with autologous dendritic cells).

## INTRODUCTION

Multiple myeloma will newly affect 13,700 individuals in the United States in 2000.<sup>1</sup> Conventional melphalan and prednisone therapy and combination chemotherapy regimens achieve responses, but few complete responses.<sup>2</sup> High-dose treatment strategies increase response rates, including complete responses, but few if any patients are cured.<sup>3,4</sup> We have therefore attempted to derive novel biologically based therapies to improve outcome and achieve prolonged disease-free survival and ultimate cure.

## METHODS

We have carried out a series of laboratory and derived clinical studies using MM cell lines and freshly isolated patient cells. These studies used previously described techniques to study Ku expression in MM,<sup>5</sup> antitumor activity of proteasome inhibitors (T. Hideshima, P. Richardson, D. Chauhan, et al., unpublished data) and thalidomide and its analogs,<sup>6</sup> cell signaling that mediates myeloma cell growth and apoptosis,<sup>7-11</sup> novel approaches for allografting to abrogate graft-vs.-host disease while preserving the GVM effect (E.P. Alyea, E. Weller, R.L. Schlossman, et al., unpublished data),<sup>12</sup> improved methods for purging tumor cells from autografts,<sup>13</sup> and novel vaccination and adoptive immunotherapy approaches (J.L. Schultze, K.C.A., M.H. Gilleece, et al., unpublished data; N. Raje, T. Hideshima, D. Avigan, et al., unpublished data).<sup>14</sup>

## RESULTS AND DISCUSSION

### Novel Chemotherapeutics

Multiple lines of evidence suggest that the precursor cell in multiple myeloma is a cytoplasmic  $\mu$ -positive B cell that has undergone antigen selection and somatic hypermutation in the lymph node but has not yet undergone isotype class switching. Chromosomal translocations involving the immunoglobulin (Ig) switch region are common, and multiple partner chromosomes have been described. Given that abnormalities in Ig gene rearrangement, IgH class switching, and DNA damage repair are hallmarks of myeloma, we have undertaken studies of Ku expression and function in human myeloma cells.<sup>5</sup> Ku is a heterodimer composed of Ku70 and Ku86 subunits that binds with high affinity to altered DNA and is essential for double-stranded DNA break (DSB) repair and normal Ig V(D)J recombination. Our studies to date have identified a 69-kDa variant of Ku86 (Ku86v) in some myeloma cells, which neither binds DNA–protein kinase catalytic subunit (DNA-PKcs) nor activates kinase activity and therefore may account for decreased DNA repair and increased sensitivity to radiation and chemotherapy; conversely, Ku86 in myeloma cells confers resistance to therapy and may represent a therapeutic target.

Myeloma cells home to the BM microenvironment, where excess plasma cells characteristic of this disease accumulate. We have demonstrated mechanisms whereby tumor cells specifically adhere to both ECM proteins and BMSCs, as well as changes in cell adhesion molecule profile correlating with egress of tumor cells into the peripheral blood (PB) in the context of progressive disease and plasma cell leukemia (PCL).<sup>15</sup> Adhesion molecules not only localize tumor cells within the BM microenvironment but also have multiple functional sequelae. Adherence to BMSCs confers resistance to apoptosis,<sup>16</sup> and agents that block adhesion, eg, bisphosphonates, can confer sensitivity to treatment. Furthermore, adherence of tumor cells to BMSCs upregulates NF $\kappa$ B-dependent IL-6 transcription and secretion within BMSCs<sup>17</sup> and also allows for tumor cell secretion of cytokines, eg, transforming growth factor- $\beta$ , which further enhances IL-6 transcription and secretion in BMSCs.<sup>18</sup> This is of central importance, because our studies have shown that IL-6 is both a growth and a survival factor for myeloma cells.<sup>19</sup> Proteasome inhibitors are novel drugs that inhibit activation of NF $\kappa$ B<sup>20</sup>; they induce apoptosis of myeloma cells that are resistant to conventional therapy, partially block tumor cell adhesion to BMSCs, and inhibit the NF $\kappa$ B-dependent upregulation of IL-6 in BMSCs and related paracrine growth of adherent tumor cells (T. Hideshima, P. Richardson, D. Chauhan, et al., unpublished data). Therefore, they represent a very attractive class of drugs that directly affect tumor cells but also target tumor cell interaction with BMSCs and the paracrine growth and survival signals provided in the marrow milieu.

We have shown that proliferation of myeloma cells triggered by IL-6 is mediated via the MAPK cascade,<sup>7</sup> suggesting therapeutic strategies based on blocking this pathway in tumor cells. Apoptosis triggered by gamma irradiation, Fas, and dexamethasone is mediated via distinct signaling cascades. For example, apoptosis induced by dexamethasone (but not gamma irradiation or Fas) is mediated via activation of RAFTK.<sup>10</sup> IL-6 is also a survival factor for human myeloma cells, specifically activating SHP2 phosphatase and thereby blocking the activation of RAFTK and related apoptosis in response to dexamethasone.<sup>11</sup> Blocking SHP2 activation with small-molecule SHP2 inhibitors may therefore relieve this protective effect. Further delineation of these pathways will help us derive strategies for triggering apoptosis, overcoming dexamethasone resistance, and inhibiting survival signals, which will provide the framework for related novel treatment approaches.<sup>21</sup>

Our recent studies also suggest that adhesion of myeloma cells to BMSCs upregulates VEGF secretion by BMSCs and myeloma cells. Therefore, in addition to examining the effect of VEGF on BM angiogenesis, we are evaluating whether VEGF is a growth and/or survival factor for myeloma cells. Preliminary studies suggest that VEGF induces MAPK activation and proliferation of some myeloma cells and that VEGF receptor inhibitors block proliferation of tumor cells and may therefore be useful clinically. This increase in VEGF may in part account for increased angiogenesis in human myeloma BM. Based on its antiangiogenic activity, thalidomide was recently used very successfully to treat patients with myeloma, even those refractory to conventional therapy.<sup>22</sup> Although thalidomide may be acting in myeloma as an antiangiogenic agent, there are multiple other potential mechanisms of action of thalidomide and/or its *in vivo* metabolites.<sup>23</sup> First, thalidomide may have a direct effect on the myeloma cell and/or BM stromal cell to inhibit growth and survival. For example, free radical-mediated oxidative DNA damage may play a role in the teratogenicity of thalidomide and may also have antitumor effects. Second, adhesion of myeloma cells to BMSCs both triggers secretion of cytokines that augment myeloma cell growth and survival and confers drug resistance; thalidomide modulates adhesive interactions and thereby may alter tumor cell growth, survival, and drug resistance. Third, cytokines secreted into the BM microenvironment by myeloma and/or BMSCs, such as IL-6, IL-1 $\beta$ , IL-10, and tumor necrosis factor (TNF)- $\alpha$ , may augment myeloma cell growth and survival, and thalidomide may alter their secretion and bioactivity. Fourth, VEGF and basic fibroblast growth factor (bFGF)-2 are secreted by myeloma and/or BMSCs and may play a role in tumor cell growth and survival, as well as BM angiogenesis. Given its known antiangiogenic activity, thalidomide may inhibit activity of VEGF, bFGF-2, and/or angiogenesis in myeloma. Finally, thalidomide may be acting against myeloma via its immunomodulatory effects, such as induction of a T helper 1 (Th1) T-cell response with secretion of interferon (IFN)- $\gamma$



and IL-2. Understanding which of these mechanisms mediates antimyeloma activity will be critical both to optimally define its clinical utility and to derive analogs with enhanced potency and fewer side effects.

Already, 2 classes of thalidomide analogs have been reported, including phosphodiesterase 4 inhibitors—which inhibit TNF- $\alpha$  but have little effect on T-cell activation—and others that are not phosphodiesterase inhibitors but do markedly stimulate T-cell proliferation as well as IFN- $\gamma$  and IL-2 secretion.<sup>24</sup> In recent studies, we delineated mechanisms of antitumor activity of thalidomide and its potent analogs (IMiDs).<sup>6</sup> Importantly, these agents act directly, via inducing apoptosis or G<sub>1</sub> growth arrest, in myeloma cell lines and patient myeloma cells that are resistant to melphalan, doxorubicin, and dexamethasone. Moreover, thalidomide and the IMiDs enhance the antimyeloma activity of dexamethasone, and as for dexamethasone, apoptotic signaling triggered by thalidomide and the IMiDs is associated with activation of RAFTK. Most recent studies suggest that treatment with these drugs alters their adherence to BMSCs and fibronectin and abrogates the upregulation of IL-6 and VEGF induced by tumor cell binding. Finally, these drugs appear to upregulate natural killer (NK) cell-mediated killing of myeloma cells. These studies establish the framework for the development and testing of thalidomide and the IMiDs in a new treatment paradigm to target both the tumor cell and the microenvironment, overcome classical drug resistance, and achieve improved outcome in this presently incurable disease.

### **Novel Immune-Based Strategies**

High response rates can be achieved using high-dose therapy followed by stem cell grafting; however, patients are destined to relapse, and few if any are cured. Major obstacles to cure are the excessive toxicity noted after allografting in myeloma, contaminating tumor cells in autografts, and most importantly, the persistence of minimal residual disease after high-dose therapy followed by either allogeneic or autologous stem cell transplantation. In this context, we are developing improved strategies to treat MRD after high-dose therapy followed by allogeneic or autologous stem cell grafting. Most importantly, we are developing multiple approaches for the generation and enhancement of allogeneic and autologous antimyeloma immunity *in vitro* and in animal models. Based on these studies, we are designing clinical trials that couple our treatments to achieve MRD with these novel immune-based therapies for MRD posttransplant in an attempt to achieve long-term disease-free survival and potential cure of multiple myeloma.

We have carried out high-dose therapy followed by T-cell (CD6)–depleted allografting using histocompatible sibling donors in 61 patients with myeloma whose disease remained sensitive to conventional chemotherapy (E.P. Alyea, E. Weller, R.L. Schlossman, et al., unpublished data). The patients included 39

men and 22 women with a median age of 44 years (range, 32–55 years). Most patients presented with advanced-stage myeloma. The majority of patients achieved either complete (28%) or partial (57%) response; importantly, only 17% of patients developed grade 2 or higher graft-vs.-host disease (GVHD), and the transplant-related mortality was only 5%. Therefore, we have shown that allografting can be done safely in myeloma. Indeed, in our center, the overall and progression-free survival rates of allograft and autograft recipients are equivalent, with approximately 40% of patients surviving at 3 years. However, only 20% of patients are disease-free at  $\geq 4$  years posttransplant. Excitingly, data from our center and others unequivocally demonstrate that donor lymphocyte infusions mediate a GVM effect that can effectively treat relapsed myeloma after allografting.<sup>12,25</sup> Unfortunately, GVHD is a frequent cause of morbidity and mortality after DLI. At our Myeloma Center, however, 5 of 7 patients who relapsed after CD6-depleted allografting responded—including 3 complete responses—to CD4<sup>+</sup> T-cell-enriched DLI, in some cases in the absence of GVHD. This raised the possibility that distinct T-cell clones may be mediating GVM vs. GVHD. Given the high response rates but inevitable relapses observed in the setting of allografting for myeloma, we are now testing in a clinical protocol whether CD4<sup>+</sup> DLI at 6 months after CD6-depleted allografting may mediate GVM, which will effectively treat MRD and thereby improve outcome. To date, 21 patients have undergone CD6-depleted allografting, 18 of whom developed only grades 0–1 GVHD. Eleven of these 18 patients are  $>6$  months posttransplant and have received CD4<sup>+</sup> DLI. Eight of the 11 patients who received DLI demonstrated further response (including 4 complete responses), suggesting the potential of DLI to treat MRD. Therefore, our studies already suggest that GVM can be adoptively transferred in this fashion. We are also examining T-cell repertoire, based on V $\beta$  T cell receptor gene rearrangement, to identify those clonal T cells associated with GVM and their target antigens on tumor cells.<sup>26,27</sup> Already, we have shown that T cells mediating GVM can target idiotypic antigens, and we are presently identifying other target antigens. The goal of these studies is to characterize, isolate, and expand GVM T-cell clones for antigen-specific adoptive immunotherapy.

Although randomized studies convincingly demonstrate a survival advantage for myeloma patients treated with high-dose therapy and autografting compared with those receiving conventional chemotherapy,<sup>3</sup> this treatment is not curative. Two sites of MRD contribute to the failure of autografting: in the autograft and in the patient after myeloablative therapy. At our center, to date, we have carried out high-dose therapy and stem cell autografting in 105 patients who presented with advanced-stage myeloma but whose disease remained sensitive to chemotherapy. As in our allografting experience, the majority of patients responded, including 30% complete and 62% partial responses. However, none of these patients are cured. We have produced monoclonal antibodies in the laboratory that have been

used to deplete tumor cells from myeloma autografts.<sup>28</sup> We have also evaluated CD34 selection techniques to select normal hematopoietic progenitor cells within autografts.<sup>29</sup> However, any one of these methods depletes only 2–3 logs of tumor cells, and >50% autografts still contain MRD. Based on our laboratory data that myeloma cells express Muc-1 and adenoviral receptors, we have specifically transduced tumor cells within myeloma autografts with the thymidine kinase gene (*tK*) using an adenoviral vector with a tumor-selective (Muc-1) promoter, followed by purging tumor cells *ex vivo* by treatment with ganciclovir.<sup>13</sup> Pilot studies suggest that >6–7 logs of tumor cells can be purged under conditions that do not adversely affect normal hematopoietic progenitor cells, setting the stage for a clinical trial of adenoviral purging before autotransplantation. We are also attempting to generate and expand antimyeloma-specific autologous T cells *ex vivo* for adoptive immunotherapy of MRD in the patient after autotransplant. It is now possible to clone the gene for the patient's specific idiotypic protein, use computer programs to identify gene sequences encoding for peptides predicted to be presented within the groove of class I human leukocyte antigen (HLA) of a given patient's HLA type, and expand peptide-specific T cells *ex vivo*.<sup>30</sup> A similar strategy can be used to expand T cells against peptides within shared antigens that are overexpressed on myeloma cells, such as telomerase catalytic subunit (hTERT),<sup>14</sup> Muc-1,<sup>31</sup> or CYP1B1.<sup>32</sup> Strategies are being tested to enhance the immunogenicity of the whole tumor. Our laboratory studies have also shown that autologous T cells do not proliferate to the patients' own tumor cells as targets in an autologous mixed lymphocyte reaction. However, CD40 activation of myeloma cells upregulates class I and II HLA, costimulatory, GRP94, and other molecules, and CD40-activated myeloma cells trigger a brisk autologous T-cell response (J.L. Schultze, K.C.A., M.H. Gilleece, et al., unpublished data). T cells can therefore be harvested from myeloma patients before autografting, expanded *ex vivo* using CD40-activated autologous myeloma cells as stimuli, and given as adoptive immunotherapy to treat MRD posttransplant.

Finally, we are developing and examining the clinical utility of a variety of myeloma vaccines. First, based on our observation that CD40-activated myeloma cells trigger a brisk autologous T-cell response, we will examine the utility of vaccinations of patients with autologous CD40-activated tumor cells. Second, based on our demonstration of the expression of Muc-1 core protein on freshly isolated myeloma cells,<sup>31</sup> we will construct and evaluate 2 vaccines: recombinant vaccinia virus containing the Muc-1 gene and autologous dendritic cells (DCs) transduced using adenoviral vectors with Muc-1. Excitingly, we have recently shown that myeloma cells can be fused to DCs and that the use of the myeloma cell–DC fusion as an antigen-presenting cell presents the entire myeloma cell as foreign. In a syngeneic murine myeloma model, vaccinations with myeloma cell–DC fusions, but not with myeloma cells or DCs alone, demonstrate both protective

and therapeutic efficacy. Most importantly, we have shown that patient myeloma cells can be fused to autologous DCs, which are readily isolated from either BM or PB,<sup>33</sup> and that autologous myeloma cell–DC fusions can trigger specific cytolytic autologous T-cell responses in vitro (N. Raje, T. Hideshima, D. Avigan, et al., unpublished data). We will therefore translate these findings to the bedside in clinical trials of myeloma-DC fusion vaccines to assess in vivo myeloma-specific T- and B-cell responses, as well as clinical efficacy. Ultimately, vaccinations will be coupled with adoptive immunotherapy in an attempt to treat MRD after autografting and thereby improve outcome.

### REFERENCES

1. Greenlee RT, Murray T, Bolden S, et al. Cancer statistics, 2000. *CA Cancer J Clin* 50:7–33, 2000.
2. Gregory WM, Richards MA, Malpas JS. Combination chemotherapy versus melphalan and prednisolone in the treatment of multiple myeloma: an overview of published trials. *J Clin Oncol* 10:334–342, 1992.
3. Attal M, Harousseau JL, Stoppa AM, et al. Autologous bone marrow transplantation versus conventional chemotherapy in multiple myeloma: a prospective, randomized trial. *N Engl J Med* 335:91–97, 1996.
4. Femand J-P, Ravaud P, Chevret S, et al. High-dose therapy and autologous peripheral blood stem cell transplantation in multiple myeloma: up-front or rescue treatment? Results of a multicenter sequential randomized clinical trial. *Blood* 92:3131–3136, 1998.
5. Tai YT, Teoh G, Lin B, et al. Ku86 variant expression and function in multiple myeloma cells is associated with increased sensitivity to DNA damage. *J Immunol* 165: 6347–6355, 2000.
6. Hideshima T, Chauhan D, Shima Y, et al. Thalidomide and its analogs overcome drug resistance of human multiple myeloma cells to conventional therapy. *Blood* 96:2943–2950, 2000.
7. Ogata A, Chauhan D, Teoh G, et al. Interleukin-6 triggers cell growth via the *ras*-dependent mitogen-activated protein kinase cascade. *J Immunol* 159:2212–2221, 1997.
8. Chauhan D, Pandey P, Ogata A, et al. Dexamethasone induces apoptosis of multiple myeloma cells in a JNK/SAP kinase independent mechanism. *Oncogene* 15:837–843, 1997.
9. Chauhan D, Pandey P, Ogata A, et al. Cytochrome-c dependent and independent induction of apoptosis in multiple myeloma cells. *J Biol Chem* 272:29995–29997, 1997.
10. Chauhan D, Hideshima T, Pandey P, et al. RAFTK/PYK2-dependent and -independent apoptosis in multiple myeloma cells. *Oncogene* 18:6733–6740, 1999.
11. Chauhan D, Pandey P, Hideshima T, et al. SHP2 mediates the protective effect of interleukin-6 against dexamethasone-induced apoptosis in multiple myeloma cells. *J Biol Chem* 275:27845–27850, 2000.
12. Alyea EP, Soiffer RJ, Canning C, et al. Toxicity and efficacy of defined doses of CD4<sup>+</sup> donor lymphocytes for treatment of relapse after allogeneic bone marrow transplant.

- Blood* 91:3671–3680, 1998.
13. Teoh G, Chen L, Urashima M, et al. Adenovirus vector-based purging of multiple myeloma cells. *Blood* 92:4591–4601, 1998.
  14. Vonderheide RH, Hahn WC, Schultze JL, et al. The telomerase catalytic subunit is a widely expressed tumor-associated antigen recognized by cytotoxic T lymphocytes. *Immunity* 10:673–679, 1999.
  15. Teoh G, Anderson KC. Interaction of tumor and host cells with adhesion and extracellular matrix molecules in the development of multiple myeloma. *Hematol Oncol Clin N Am* 11:27–42, 1997.
  16. Damiano JS, Cress AE, Hazelhurst LA, et al. Cell adhesion mediated drug resistance (CAM-DR): role of integrins and resistance to apoptosis in human myeloma cell lines. *Blood* 93:1658–1667, 1999.
  17. Chauhan D, Uchiyama H, Akbarali Y, et al. Multiple myeloma cell adhesion-induced interleukin-6 expression in bone marrow stromal cells involves activation of NF- $\kappa$ B. *Blood* 87:1104–1112, 1996.
  18. Urashima M, Ogata A, Chauhan D, et al. Transforming growth factor  $\beta$ 1: differential effects on multiple myeloma versus normal B cells. *Blood* 87:1928–1938, 1996.
  19. Hallek M, Bergsagel PL, Anderson KC. Multiple myeloma: increasing evidence for a multistep transformation process. *Blood* 91:3–21, 1998.
  20. Dou Q, Li B. Proteasome inhibitors as potential novel anticancer agents. *Drug Resist Updates* 2:215–223, 1999.
  21. Chauhan D, Anderson KC. Apoptosis in multiple myeloma: therapeutic implications. *Apoptosis*. In press.
  22. Singhal S, Mehta J, Desikan R, et al. Anti-tumor activity of thalidomide in refractory multiple myeloma. *N Engl J Med* 341:1565–1571, 1999.
  23. Raje N, Anderson KC. Thalidomide: a revival story. *N Engl J Med* 341:1606–1609, 1999.
  24. Corral LG, Haslett PAJ, Muller GW, et al. Differential cytokine modulation and T cell activation by two distinct classes of thalidomide analogues that are potent inhibitors of TNF- $\alpha$ . *J Immunol* 163:380–386, 1999.
  25. Lokhorst HM, Schattenberg JJ, Cornelissen JJ, et al. Donor lymphocyte infusions are effective in relapsed multiple myeloma after allogeneic bone marrow transplantation. *Blood* 90:4206–4211, 1997.
  26. Orsini E, Alyea EP, Schlossman R, et al. Changes in T cell receptor repertoire associated with graft-versus-tumor effect and graft-versus-host disease in patients with relapsed multiple myeloma after donor lymphocyte infusion. *Bone Marrow Transplant* 25:623–632, 2000.
  27. Orsini E, Alyea EP, Chillemi A, et al. Conversion to full donor chimerism following donor lymphocyte infusion is associated with disease response in patients with multiple myeloma. *Biol Blood Marrow Transplant* 6:375–386, 2000.
  28. Seiden M, Schlossman R, Anderson J, et al. Monoclonal antibody-purged bone marrow transplantation therapy for multiple myeloma. *Leuk Lymphoma* 17:87–93, 1995.
  29. Vescio R, Schiller GJ, Stewart AK, et al. Multicenter phase III trial to evaluate CD34<sup>+</sup> selected versus unselected autologous peripheral blood progenitor cell transplantation in multiple myeloma. *Blood* 93:1858–1868, 1999.

30. Trojan A, Schultze JL, Witzens M, et al. Immunoglobulin framework-derived peptides function as cytotoxic T-cell epitopes commonly expressed in B-cell malignancies. *Nat Med* 6:667–672, 2000.
31. Treon SP, Mollick JA, Urashima M, et al. Muc-1 core protein is expressed on multiple myeloma cells and is induced by dexamethasone. *Blood* 93:1287–1298, 1999.
32. Maecker B, Sherr DH, Shen C, et al. Targeting universal tumor antigens with cytotoxic T cells: potential of CYP1B1 for broadly applicable antigen-specific immunotherapy [abstract]. *Blood* 94 (Suppl):438a, 1999.
33. Raje N, Gong J, Chauhan D, et al. Bone marrow and peripheral blood dendritic cells from patients with multiple myeloma are phenotypically and functionally normal despite the detection of Kaposi's sarcoma herpesvirus gene sequences. *Blood* 93:1487–1495, 1999.

# Multiple Myeloma: Update on the Arkansas Experience—Year 2000

**Guido Tricot, Bart Barlogie**

*University of Arkansas for Medical Science, Little Rock, Arkansas*

## INTRODUCTION

Autologous transplantation in multiple myeloma (MM) was introduced 15 years ago, initially as a palliative measure for patients who had failed multiple regimens of conventional therapy, but now applied with the intent to cure, especially in patients early after diagnosis. The mainstay of conventional therapy has been the melphalan and corticosteroids regimen. Our intensive treatment approach still has melphalan and corticosteroids as the backbone, but at maximally escalated doses. Analysis of our Total Therapy Program (1989–1994) indicates that cure is a realistic goal with autologous transplantation.

## TOTAL THERAPY

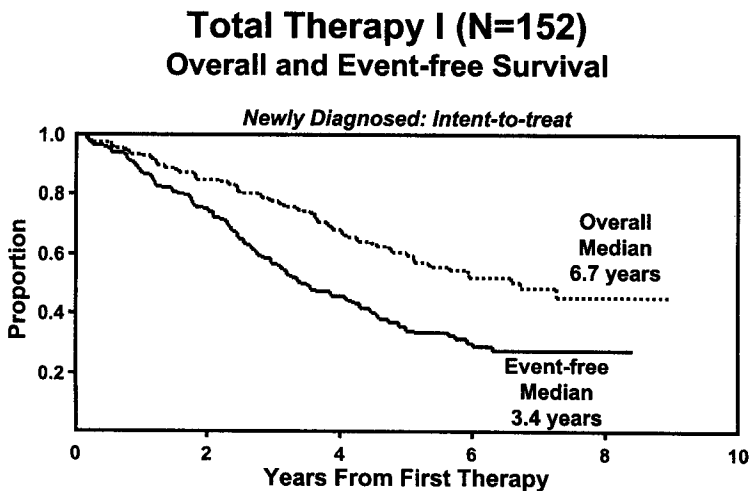
The intent of this program was to combine, in recently diagnosed MM patients (0 or 1 cycle of conventional chemotherapy), all active agents that were available at that time in a rapid sequence using non-cross-resistant drugs at maximally tolerated dose during induction and mobilization phases. This was followed by tandem transplants with melphalan 200 mg/m<sup>2</sup>. However, if less than a partial remission was attained after the first transplant, the preparative regimen for the second transplant consisted of melphalan 140 mg/m<sup>2</sup> with total body irradiation (TBI), or melphalan 200 mg/m<sup>2</sup> with cyclophosphamide 120 mg/kg for those in whom TBI was not feasible. This was followed by interferon maintenance. A total of 321 patients were enrolled; 152 of these patients had received no conventional treatment before enrollment. The characteristics are outlined in Table 1. The median follow-up is now >7 years. The median overall survival (OS) for these patients is 6.7 years, with 48% of the patients alive at 7 years; the median event-free survival (EFS) is 3.4 years, with 27% EFS at 7 years (Figure 1). The median complete remission (CR) duration was 3.9 years, with 44% still in CR at 7 years. The total CR rate was 41%. The transplant-related mortality was 1% with the first and 2% with the second transplant. In a multivariate analysis, the absence of a chromosome 13 abnormality and a C-reactive protein (CRP) level <4 mg/L at

**Table 1.** Total Therapy I: Characteristics of Untreated Patients ( $N = 152$ )\*

Parameter	%
-13/del 13	14
B2M >3.0 mg/L	51
CRP >4.0 mg/L	45
IgA isotype	17
Albumin <3.5 g/dL	30
Creatinine >2.0 mg/L	11
LDH >190 U/L	21
Hemoglobin <10 g/dL	33
Completed HDT-1	89
Completed HDT-2	77
Median follow-up, y	6

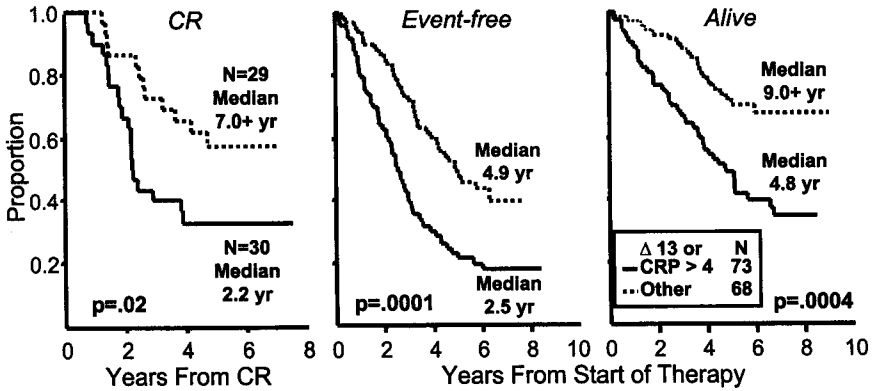
\*B2M, B-2 microglobulin; CRP, C-reactive protein; HDT, high-dose therapy; Ig, immunoglobulin; LDH, lactate dehydrogenase.

diagnosis were the most important factors associated with a good outcome. Of the total group, 68 patients had both favorable variables; 73 had either one or no favorable variables. In the good-prognosis group, the median CR duration was >7 years, with a 7-year CR rate of 60%, the median EFS was 4.9 years, and the median OS was 9 years, with 70% of these patients still alive at 7 years (Figure 2). Figure 3 compares survival with tandem transplants for good- and poor-prognosis patients with that of 723 myeloma patients under the age of 70 years treated with conven-

**Figure 1.** Overall and event-free survival for Total Therapy I ( $n = 152$ ).



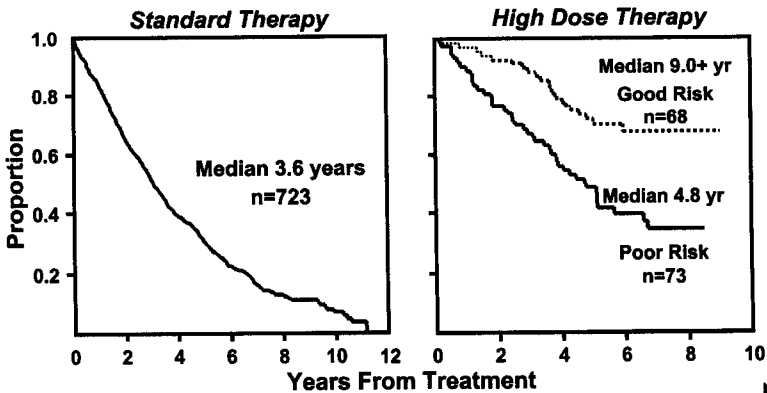
**Superior Prognosis in Absence of  $\Delta 13$  and with Low CRP**



**Figure 2.** Duration of complete remission (CR), event-free and overall survival in newly diagnosed patients treated on Total Therapy I. CRP, C-reactive protein.

tional therapy on 4 consecutive SWOG studies. Even the poor-prognosis patients fared much better than the whole group of conventionally treated patients, irrespective of prognostic factors. When we compare our results with tandem transplants to those published by the Intergroupe Français du Myelome (IFM)

**Survival in Myeloma**



**Figure 3.** Comparison of overall survival with standard therapy in 4 consecutive SWOG studies versus tandem transplants in newly diagnosed patients on Total Therapy I.

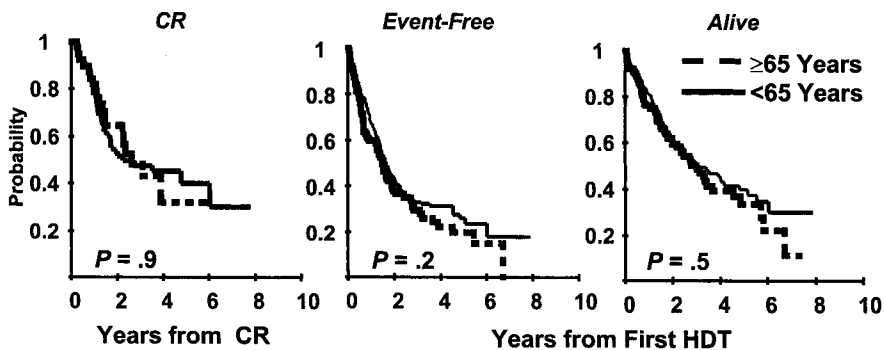
**Table 2.** Single vs. Tandem Transplant\*

	HDT		
	Attal Single	Powles Single	Barlogie Tandem
<i>n</i>	100	195	152
CR rate, %	22	53	41
EFS, mo	27	25	41
EFS at 5 years, %	24	NA	34
OS, mo	57	54	80
OS at 5 years, %	47	NA	60

\*CR, complete remission; EFS, event-free survival; HDT, high-dose therapy; OS, overall survival.

Study Group (IFM-90) and Royal Marsden (Powles et al.), the EFS and OS as well as EFS and OS at 5 years appear much better with tandem transplants (Table 2). The high CR rate in the Powles series is due to the use of nonstrict CR criteria. In addition, application of a second transplant increased the CR rate for our total therapy patients on an intent-to-treat basis from 26% to 41%. The IFM 94 study comparing single vs. tandem transplants showed higher CR and VGPR (very good partial remission) rates ( $P=.6$ ) and EFS at 4 years ( $P=.07$ ) in the tandem transplant group. It is very likely that with longer follow-up the EFS will become significantly different. A higher CR rate and better EFS for tandem transplants was also reported by an Italian group.<sup>1</sup> Taking all these data together, there is strong evidence that tandem transplants are superior to a single transplant. The next SWOG myeloma

## Comparable Survival in Young & Old Pair Mates after High-Dose Therapy



**Figure 4.** Absence of difference in complete remission (CR) duration, event-free and overall survival in patients  $\geq 65$  years versus younger patients.

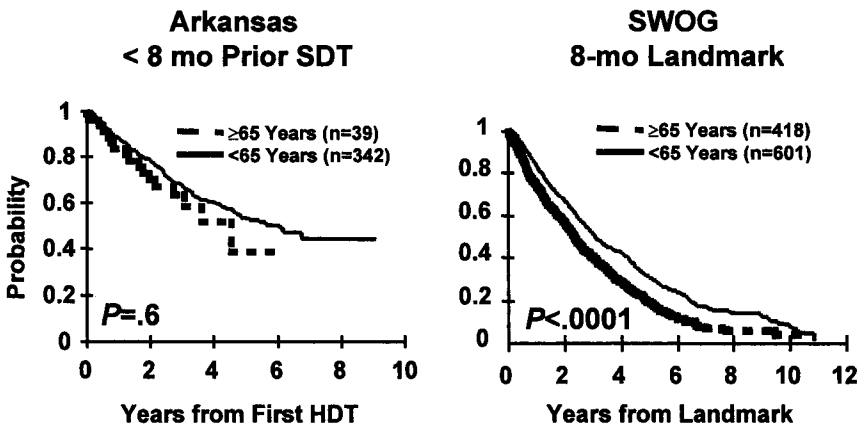
**Table 3.** Multivariate Analysis of Prognostic Variables\*

Favorable Variable	CR		CR Duration		EFS		OS	
	OR	P	OR	P	OR	P	OR	P
Age <65 y	—	NS	—	NS	—	NS	—	NS
No del 13	2.1	.0003	0.7	.03	0.5	<.0001	0.4	<.0001
B2M <2.5	1.5	.006	—	NS	0.7	<.0001	0.6	<.0001
Sensitive	3.2	<.0001	—	NS	0.7	<.0001	0.7	.0005
CRP <4	—	NS	0.7	.01	0.8	.04	0.7	.0004
Non-IgA	0.6	.002	0.6	.003	0.8	.004	0.7	.002
SDT <12 mo†	2.0	<.0001	0.6	<.0001	0.6	<.0001	0.7	<.0001
Timeliness of second HDT cycle†					0.7	.001	0.5	<.0001

\*B2M, B-2 microglobulin; CR, complete remission; CRP, C-reactive protein; EFS, event-free survival; HDT, high-dose therapy; Ig, immunoglobulin; NS, not significant; OR, odds ratio; OS, overall survival; SDT, standard dose therapy. †Variables that can be controlled through medical intervention.

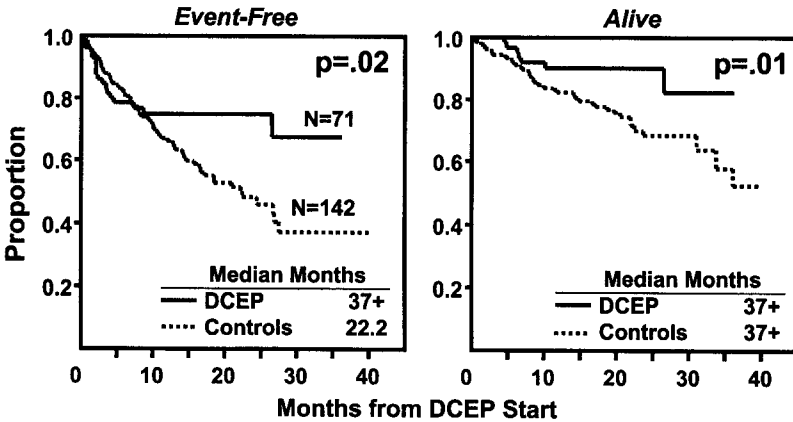
study will have a tandem transplant incorporated for all patients. The new IFM study also provides for tandem transplants in all patients with good prognostic factors and in those with poor prognosis without a matching sibling donor.

### Overall Survival: Arkansas High-Dose Therapy and SWOG Standard-Dose Therapy



**Figure 5.** HDT, high-dose therapy; SDT, standard dose therapy.

## Superior Outcome with DCEP Maintenance Pair-mate Analysis



**Figure 6.** DCEP, dexamethasone, cyclophosphamide, etoposide, and cisplatin.

### AGE AND TRANSPLANTATION

Age has independent adverse prognostic implications with standard therapy, with patients between 65 and 74 years of age faring significantly worse than those <65 years of age after adjusting for B-2 microglobulin, creatinine, and calcium. We compared in our database the outcome of 102 patients over the age of 65 years who had received high-dose therapy to that of 204 control subjects under the age of 65 years matched for cytogenetics, B-2 microglobulin, duration of prior therapy, C-reactive protein levels, and presence of resistant disease. CR duration, EFS, and OS were comparable in the 2 groups (Figure 4). In multivariate analysis, age was not a significant factor for CR rate, CR duration, EFS, or OS (Table 3). Because 90% of patients entered on transplant protocols have received their first transplant within 8 months after enrollment on study, an 8-month landmark analysis was performed on patients treated on 4 consecutive SWOG protocols. Figure 5 shows that age was not important for patients' outcome with high-dose therapy, while patients over the age of 65 years fared significantly worse with standard therapy ( $P<.0001$ ). There is no scientific reason to systemically exclude myeloma patients from transplantation based on only age. It should be the preferred therapy for older patients who do not have severe comorbid conditions.

## POSTTRANSPLANT CHEMOTHERAPY

In patients with limited prior treatment with standard therapy (<12 months), most of the relapses posttransplantation occur late (>24 months). In an attempt to reduce the late relapse rate, we explored the concept of posttransplantation chemotherapy given at regular intervals (3 months) for 1 year. The chemotherapy employed was DCEP (dexamethasone, cyclophosphamide, etoposide, and cisplatin), which was found to be effective in patients who had relapsed after autotransplant, with 40% of these patients reducing their abnormal protein by >75% and their bone marrow plasmacytosis to <5%; 13% attained a CR. This regimen was well tolerated. The major toxicities were hematologic (neutropenia and thrombocytopenia). Patients eligible for this study had to have good hematologic recovery posttransplantation and a creatinine level <2 mg/dL. The outcome of 71 patients receiving DCEP posttransplant was compared with that of 142 previously transplanted patients who had not received DCEP. The 2 groups were matched for all important prognostic variables. Figure 6 shows the superior EFS and OS for patients who received posttransplantation consolidation. Superior EFS and OS rates were observed for good- as well as poor-prognosis patients. Posttransplantation chemotherapy has now become an integral part of our transplant program.

## FUTURE DIRECTIONS

Our aims for the treatment of myeloma have shifted from palliative to curative in the last decade. Cure can be obtained only by prolonged treatment with cytotoxic therapy given at maximal doses in a dose-dense schedule.

In newly diagnosed patients, we are currently evaluating whether the combination of thalidomide with intense therapy is better than intensive therapy alone. It is possible that posttransplant chemotherapy with DCEP is still not intensive enough for patients with poor prognosis and that further transplants will be necessary to ultimately improve EFS significantly. This approach, as well as dendritic cell vaccination, will be explored in poor-prognosis patients.

## REFERENCES

1. Lemoli RM, Martinelli G, Zamagni E, et al. Engraftment, clinical, and molecular follow-up of patients with multiple myeloma who were reinfused with highly purified CD34<sup>+</sup> cells to support single or tandem high-dose chemotherapy. *Blood* 95:2234–2239, 2000.

# **Advances in Allogeneic Transplantation for Multiple Myeloma Using Bone Marrow and Peripheral Blood Stem Cells**

**G. Gahrton, H. Svensson, M. Cavo, J. Apperley, A. Bacigalupo,  
B. Bjorkstrand, J. Blade, J. Cornelissen, A. de Laurenzi, T. Facon,  
P. Ljungman, M. Michallet, D. Niederwieser, R. Powles, J. Reiffers,  
N.H. Russell, D. Samson, U.W. Schaefer, A. Schattenberg,  
S. Tura, L.F. Verdonck, J.P. Vernant, R. Willemze, L. Volin,  
for the European Group for Blood and Marrow Transplantation**

*Departments of Medicine and Hematology (G.G.), Karolinska Institutet;  
Huddinge University Hospital (all authors), Huddinge, Sweden*

## **INTRODUCTION**

Centers within the European Group for Blood and Marrow Transplantation (EBMT) have performed allogeneic bone marrow transplantation for multiple myeloma since 1983,<sup>1-4</sup> and transplant results are regularly reported to the EBMT myeloma registry. Previous reports from this registry as well as from other centers<sup>5-7</sup> have shown that allogeneic transplantation is associated with high transplant-related mortality compared with autologous transplantation; in EBMT studies, however, the relapse rate after allogeneic transplantation was significantly lower than after autologous transplantation.<sup>8</sup> Thus, if transplant-related mortality could be reduced, allogeneic transplantation would be a more promising approach for the treatment of younger patients than autologous transplantation. In 1995, the EBMT compared the outcome of allogeneic transplants during the periods 1983-1988 and 1989-1994 in the hope that better supportive treatment could have improved results. However, no significant time-dependent improvement in outcome could be seen.<sup>4</sup> In 1994, the first allogeneic transplants using peripheral blood stem cells (PBSCs) were performed in multiple myeloma within EBMT centers. In 1999, a comparison between such transplants and bone marrow transplants was performed (Gahrton G, Svensson H, Cavo M, et al., unpublished data). A dramatic improvement in survival for all transplants during the period 1994-1998 vs. 1983-1993 was seen, with no significant difference between bone marrow transplants and PBSC transplants, and was due to a reduction in transplant-related mortality.

## PATIENTS AND METHODS

The EBMT study (Gahrton G, Svensson H, Cavo M, *et al.*, unpublished data) comprised 690 multiple myeloma patients. All patients received the graft from HLA-matched sibling donors. During the period 1983–1993, 334 patients received a bone marrow graft, and 223 during the period 1994–1998. During the same time period (1994–1998), 133 patients received a peripheral blood stem cell graft.

The 3 groups were relatively well matched for age, sex, subtypes, stage at diagnosis, and response before transplantation. However, the median time from diagnosis to transplantation was significantly longer in patients transplanted during 1983–1993 (median, 14 months; range, 2–168 months) than in those transplanted during 1994–1998 (bone marrow: median, 10 months; range, 3–155 months; PBSC: median, 10 months; range, 3–155 months). Obviously, the follow-up time was longer for transplants performed during 1983–1993 (median, 73 months) than for transplants performed during 1994–1998 (bone marrow: median, 22 months; PBSC: median, 10 months).

The fraction of patients that had received only 1 treatment regimen before transplantation was significantly higher in transplants performed during 1994–1998 (bone marrow, 56%; PBSC, 68%) than in those performed during 1983–1993 (45%); conversely, the proportion of patients who had received 3 or more regimens was significantly lower during the later period (bone marrow, 14%; PBSC, 12%) than during the earlier one (25%).

The conditioning regimens varied between groups and within groups, with no significant difference between them. Regimens including only total body irradiation (TBI) and cyclophosphamide were most common, followed by melphalan-containing regimens. Busulfan plus cyclophosphamide was less common.

Prevention of graft-vs.-host disease (GVHD) was at the discretion of each center. The regimen most commonly used was cyclosporine plus methotrexate without T-cell depletion. T-cell depletion with or without additional treatment was less commonly used.

Complete remission following transplantation was defined for the purpose of this study as disappearance of abnormal immunoglobulins from serum and/or light chain from the urine using either conventional electrophoresis or immunofixation, as well as disappearance of apparent myeloma cells from the marrow, as previously described.<sup>4</sup>

## RESULTS

### Response to BMT

The probability of entering complete remission (CR) at 6 months after transplantation was 53%, 54%, and 50%, and at 2 years, 60%, 60%, and 54% for

the 1983–1993, 1994–1998 (bone marrow), and 1994–1998 (PBSC) groups, respectively, with no significant difference between the groups.

### **Survival, Treatment-Related Mortality, and Relapse**

The median overall survival was 10 months for transplants performed 1983–1993 and 50 months for bone marrow transplants during 1994–1998 and was not reached for PBSC transplants during 1994–1998. The survival rates at 2 years were 40%, 57%, and 57%, and at 3 years, 35%, 55% and 57%, respectively. The 4-year survival rates were 32% and 50% for bone marrow transplants performed 1983–1993 and 1994–1998, respectively, and could not be estimated with enough confidence for PBSC transplants. The 5-year, 8-year, and 10-year survival rates could be estimated with enough confidence only for bone marrow transplants during 1983–1993: 28%, 21%, and 18%, respectively. Six patients survived >10 years following transplantation. The difference in survival between transplants performed during 1983–1993 and during 1994–1998 was highly significant ( $P<.0001$ ), whereas there was no significant difference between bone marrow and PBSC transplants during 1994–1998.

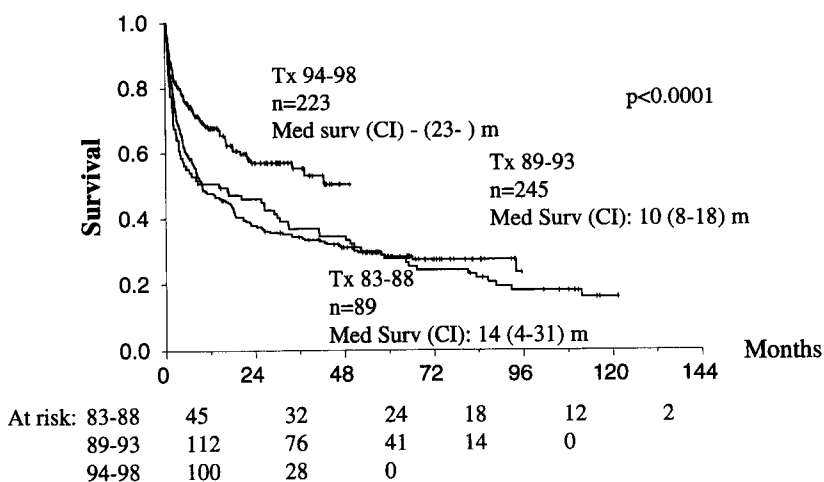
A breakdown into 3 time periods—ie, comparing 1983–1988, 1989–1993, and 1994–1998—showed no significant difference in survival between the 2 earlier time periods but a significant difference between the latest 5-year period and each of the earlier periods (Figure 1). Thus, the entire improvement in survival has occurred since 1994. The improvement in overall survival from 1994 to 1998 compared with 1983–1993 was entirely due to a reduction in treatment-related mortality. This was 38% and 21% at 6 months and 46% and 30% at 2 years for bone marrow transplants performed during 1983–1993 and 1994–1998, respectively, with no significant difference between bone marrow and PBSC transplants from 1994–1998.

The relapse rate in patients who had entered a complete remission did not differ significantly between the time periods and was 19%–24% at 2 years after transplantation.

### **Acute and Chronic GVHD**

The frequency of acute and chronic GVHD did not differ significantly between the periods or between bone marrow and PBSC transplants. However, the short follow-up for PBSC transplants hampers any firm conclusion as to possible differences in chronic GVHD.





**Figure 1.** Allogeneic transplantation in multiple myeloma. Overall actuarial survival after bone marrow transplantation according to the time of transplantation. The Kaplan-Meier curves show a significantly better survival among patients who received transplants from 1994 to 1998 than among those who received transplants during 1983–1988 or 1989–1993. CI, confidence interval; m, months; Med Surv, median survival; Tx, transplant.

### Causes of Death

At follow-up in 1999, 250 of the 340 patients (74%) transplanted during 1983–1993, 84 of the 233 patients (38%) transplanted with bone marrow during 1994–1998, and 44 of the 133 patients (33%) transplanted with PBSCs during 1994–1998 had died. Interstitial pneumonitis and bacterial/fungal infections were significantly more common causes of death in bone marrow transplants performed from 1983–1993 (14% and 17%, respectively) than for the period 1994–1998 (7% and 7%, respectively). Other causes of death such as original disease, new malignancy, acute or chronic GVHD, viral infections, adult respiratory distress syndrome (ARDS), capillary leak syndrome, rejection/poor graft, organ failure, disseminated intravenous coagulation, veno-occlusive disease (VOD), hemorrhage, and cardiac toxicity did not differ significantly. There was no significant difference in the causes of death between bone marrow and PBSC transplants performed during 1994–1998.

### DISCUSSION

Our registry study shows (Gahrton G, Svensson H, Cavo M, et al., unpublished data) that the overall survival after allogeneic bone marrow transplantation for

multiple myeloma has improved significantly over a recent 5-year period (1994–1998) compared with transplants performed during the previous 5 and 11 years. This is in contrast to earlier analyses made by the EBMT that failed to show improvement in outcome with time.<sup>4</sup> Thus, the improvement has occurred during the later 5 years from 1994 onward.

The study also shows that the improvement is due to a lower transplant-related mortality during the latest 5-year period. Acute GVHD does not appear to have changed during this period—the incidence of both overall and severe GVHD was about the same. However, there was a significant reduction in deaths caused by either interstitial pneumonitis or bacterial and fungal infections. There are several possible reasons for the reduction in interstitial pneumonitis, including better treatment of cytomegalovirus infection and perhaps changes in dosage of cytotoxic drugs and fractionation of TBI.

Earlier transplantation (10 months from diagnosis during the latest time period and 14 months during the earlier time period) has probably played an important role in reducing deaths due to bacterial and fungal infections. Earlier transplantation results in a lower number of treatment regimens before the transplant. Previous studies have shown that fewer regimens before the transplant is the second most important favorable prognostic parameter for survival in multivariate analysis.<sup>4</sup> The use of peripheral blood stem cells instead of bone marrow did not change the overall outcome per se. The transplant-related mortality was similar to that of transplantation with bone marrow cells during the same time period. Although the engraftment rate was more rapid using peripheral blood stem cells, it did not translate into reduced transplant-related mortality or significantly lower death rate due to bacterial or fungal infections.

The relapse rate does not appear to have improved with either bone marrow cells or peripheral blood stem cells. However, longer follow-up is needed for firm conclusions. Allogeneic transplantation still appears to be the most promising way to obtain cure in patients with multiple myeloma. Although occasional molecular remissions can be obtained with autologous transplantation, these are usually transient, and the frequency and durability of molecular remissions is higher using allogeneic transplantation.<sup>9–12</sup> Also, there is the possibility to use donor lymphocyte transfusions to treat patients with persistent disease or relapses following previous complete remissions.<sup>13–16</sup> Recently, nonmyeloablative conditioning followed by allogeneic transplantation has proven to be feasible and is associated with low transplant-related mortality.<sup>17–19</sup> However, the relapse risk is unknown. The EBMT, therefore, will compare nonmyeloablative transplantation following autologous transplantation in patients with a matched sibling donor to autologous transplantation alone in patients who lack such a donor.

## SUMMARY AND CONCLUSIONS

Results of allogeneic bone marrow transplantation for multiple myeloma have improved dramatically since 1994. Overall survival has improved from a median of 10 months for patients transplanted during 1983–1993 to 50 months for patients transplanted during 1994–1998. The improvement is due to a significant reduction in transplant-related mortality that was 38% at 6 months during the earlier period but only 21% during the later period. Transplantation with peripheral blood stem cells has been performed since 1994, and the results are similar to transplantation with bone marrow during the same time period. Reduced transplant-related mortality appears to be due to fewer deaths from bacterial and fungal infections and interstitial pneumonitis, in turn as a result of earlier transplantation and less prior chemotherapy. Relapse rate is mainly unchanged, but molecular remissions occur in a significant number of patients, some of them long-term survivors.

## ACKNOWLEDGMENTS

Supported by grants from the Swedish Medical Research Fund, the Swedish Cancer Fund, and Funds from the EBMT.

## REFERENCES

1. Gahrton G, Tura S, Flesch M, et al. Bone marrow transplantation in multiple myeloma: report from the European Cooperative Group for Bone Marrow Transplantation. *Blood* 69:1262–1264, 1987.
2. Gahrton G, Tura S, Ljungman P, et al. Allogeneic bone marrow transplantation in multiple myeloma. European Group for Bone Marrow Transplantation. *N Engl J Med* 325:1267–1273, 1991.
3. Cavo M, Tura S, Rosti G, et al. Allogeneic BMT for multiple myeloma (MM). The Italian experience [abstract]. *Bone Marrow Transplant* 7 (Suppl 2):31, 1991.
4. Gahrton G, Tura S, Ljungman P, et al. Prognostic factors in allogeneic bone marrow transplantation for multiple myeloma. *J Clin Oncol* 13:1312–1322, 1995.
5. Barlogie B, Jagannath S, Vesole D, Tricot G. Autologous and allogeneic transplants for multiple myeloma. *Semin Hematol* 32:31–44, 1995.
6. Bensinger WI, Buckner CD, Anasetti C, et al. Allogeneic marrow transplantation for multiple myeloma: an analysis of risk factors on outcome. *Blood* 88:2787–2793, 1996.
7. Schlossman RL, Anderson KC. Bone marrow transplantation in multiple myeloma. *Curr Opin Oncol* 11:102–108, 1999.
8. Bjorkstrand BB, Ljungman P, Svensson H, et al. Allogeneic bone marrow transplantation versus autologous stem cell transplantation in multiple myeloma: a retrospective case-matched study from the European Group for Blood and Marrow Transplantation. *Blood* 88:4711–4718, 1996.

9. Majolino I, Corradini P, Scime R, et al. Allogeneic transplantation of unmanipulated peripheral blood stem cells in patients with multiple myeloma. *Bone Marrow Transplant* 22:449–455, 1998.
10. Corradini P, Voena C, Tarella C, et al. Molecular and clinical remissions in multiple myeloma: role of autologous and allogeneic transplantation of hematopoietic cells. *J Clin Oncol* 17:208–215, 1999.
11. Cavo M, Terragna C, Martinelli G, et al. Molecular monitoring of minimal residual disease in patients in long-term complete remission after allogeneic stem cell transplantation for multiple myeloma. *Blood* 96:355–357, 2000.
12. Bjorkstrand B, Ljungman P, Bird JM, Samson D, Gahrton G. Double high-dose chemoradiotherapy with autologous stem cell transplantation can induce molecular remissions in multiple myeloma. *Bone Marrow Transplant* 15:367–371, 1995.
13. Tricot G, Vesole DH, Jagannath S, Hilton J, Munshi N, Barlogie B. Graft-versus-myeloma effect: proof of principle. *Blood* 87:1196–1198, 1996.
14. Aschan J, Lonnqvist B, Ringden O, Kumlien G, Gahrton G. Graft-versus-myeloma effect [letter]. *Lancet* 348:346, 1996.
15. Lokhorst HM, Schattenberg A, Cornelissen JJ, Thomas LL, Verdonck LF. Donor leukocyte infusions are effective in relapsed multiple myeloma after allogeneic bone marrow transplantation. *Blood* 90:4206–4211, 1997.
16. van der Griend R, Verdonck LF, Petersen EJ, Veenhuizen P, Bloem AC, Lokhorst HM. Donor leukocyte infusions inducing remissions repeatedly in a patient with recurrent multiple myeloma after allogeneic bone marrow transplantation. *Bone Marrow Transplant* 23:195–197, 1999.
17. Slavin S, Nagler A, Naparstek E, et al. Nonmyeloablative stem cell transplantation and cell therapy as an alternative to conventional bone marrow transplantation with lethal cytoreduction for the treatment of malignant and nonmalignant hematologic diseases. *Blood* 91:756–763, 1998.
18. Giralt S, Weber D, Aleman A, et al. Non myeloablative conditioning with fludarabine/melphalan (FM) for patients with multiple myeloma (MM) [abstract]. *Blood* 94 (Suppl 1):347a, 1999. Abstract 1549.
19. Molina A, McSweeney P, Maloney DG, et al. Non myeloablative peripheral blood stem cell (PBSC) allografts following cytoreductive autotransplants for treatment of multiple myeloma (MM) [abstract]. *Blood* 94 (Suppl 1):347a, 1999. Abstract 1551.

# Feasibility of Dose-Dense Therapy of Multiple Myeloma With L-Phenylalanine Mustard

*Shahid Malik, Lawrence Lum, Amy Sharron, Mary Falvey,  
Deborah Morgan, Gerald Effenbein*

*Blood and Marrow Transplant Program, Roger Williams Cancer Center,  
Providence, Rhode Island*

## ABSTRACT

L-Phenylalanine mustard (L-PAM) is a very valuable drug in the therapy of multiple myeloma. The highest dose of L-PAM usually given as a single agent is 200 mg/m<sup>2</sup>, which is then followed by hematopoietic stem cells (HSCs). We have hypothesized that it is feasible to deliver 100 mg/m<sup>2</sup> every 21 days with HSC support. Further, we have hypothesized that there would be fewer side effects on the gastrointestinal tract, so this dose-dense L-PAM could be delivered on an outpatient basis. Four patients were enrolled in this phase 1/2 pilot study. Their clinical courses were substantially no more complicated than those of patients receiving our traditional chemotherapy with cyclophosphamide 3.5 g/m<sup>2</sup> to mobilize HSCs. All 4 patients had sufficient hematopoietic recovery after the third cycle to tolerate subsequent intended immunoconsolidation therapy.

## INTRODUCTION

L-Phenylalanine mustard is one of the most active cytotoxic agents in the treatment of multiple myeloma. Along with corticosteroids, L-PAM has been a mainstay of therapy for multiple myeloma for more than 30 years. The usual (standard) dose of L-PAM is 32–40 mg/m<sup>2</sup> by mouth every 4 to 6 weeks as determined by recovery of blood counts.<sup>1</sup> The highest reported dose of L-PAM given intravenously without HSC support is 140 mg/m<sup>2</sup>, about 4 to 5 times the standard dose.<sup>2</sup> After this dose of L-PAM, recovery of blood counts takes up to 6 weeks. The maximum tolerable dose of L-PAM as a single agent is 240 mg/m<sup>2</sup> (about 6 to 8 times the standard dose); less (eg, 140 mg/m<sup>2</sup>) is often used in combination with busulfan or total body irradiation.<sup>3</sup> The usual dose of L-PAM as a single agent is 200 mg/m<sup>2</sup> (about 5 to 7 times the standard dose) followed by HSC infusion to rescue the patient from what otherwise would be a prolonged period of pancytopenia. HSCs from the peripheral blood dramatically shorten the period of aplasia after high-dose L-PAM.

There are numerous reports about the value of high-dose chemotherapy followed by HSCs for multiple myeloma.<sup>3-11</sup> Long term follow-up data for patients treated with 140 mg/m<sup>2</sup> L-PAM suggest the possibility that augmentation of L-PAM beyond standard doses may provide a survival advantage in multiple myeloma.<sup>2</sup> It is conceivable that doses of L-PAM higher than 200 mg/m<sup>2</sup> would be beneficial in multiple myeloma, but principally gastrointestinal toxicity (mucositis and enteritis) precludes its use at more than 200 mg/m<sup>2</sup>. It is also conceivable that multiple doses of L-PAM would be beneficial in multiple myeloma. This concept underlies the practice of tandem transplants for multiple myeloma.<sup>3,11</sup> Tandem transplants are actually 2 courses of high-dose chemotherapy with HSC rescue following each course.

We have hypothesized that it is feasible to deliver 3 cycles of L-PAM (each followed by autologous HSC infusion on the next day) at 100 mg/m<sup>2</sup> with 3-week intervals between doses of L-PAM, and that this could be done in the outpatient setting. We expected to see rapid recovery of blood counts and very few side effects. We call this strategy dose-dense L-PAM. In this strategy, 50% more L-PAM would be delivered within a period of 43 days, with full recovery of counts in 63 days and an expectation of fewer side effects than from a single course of high-dose L-PAM followed by HSC transplantation. The total dose of L-PAM is 300 mg/m<sup>2</sup>, which is about 7.5 to 9.3 times that delivered by a single course of standard-dose L-PAM. Dose-dense L-PAM delivers from 3.8 to 4.7 times what would be delivered over the same time period by 2 courses of standard-dose L-PAM.

## MATERIALS AND METHODS

To mobilize HSCs, and also to cytoreduce the multiple myeloma, chemotherapy and a hematopoietic growth factor were given. Mobilization involved cyclophosphamide 1.75 gm/m<sup>2</sup> intravenously for 2 days and prednisone 2 mg/kg orally for 4 days followed by granulocyte-colony stimulating factor (G-CSF) 10 µg/kg starting on day 3 of chemotherapy and continuing until HSC collection was completed. HSCs were collected when the white blood cell count rose above 1000/µL. The first day's leukapheresis product was frozen as a backup, and the remainder of the leukapheresis products were subjected to CD34<sup>+</sup> cell positive selection. After positive selection, equal numbers of cells were frozen in 3 separate aliquots.

Dose-dense L-PAM was delivered in the outpatient setting at 100 mg/m<sup>2</sup> over 1 hour every 3 weeks for 3 cycles. One aliquot of selected HSCs was reinfused in the outpatient setting 24 hours after each cycle of L-PAM. Starting 5 days after HSC infusion, trovafloxacin was given at 200 mg/day orally and fluconazole was given at 200 mg/day orally to prevent admission for neutropenic fever or documented infection. Starting 1 day after HSC infusion, to accelerate granulocyte recovery, G-CSF was given at 5 µg/kg per day subcutaneously. Platelet transfusions were given in the outpatient setting for platelet counts <20,000/µL.

**Table 1.** Patient Characteristics

Number of patients	4
Median age, y (range)	52 (44–66)
Sex, M/F	3/1
Disease stage	III
Disease status	
First response	3
Second response	1

The clinical end points of this study were, for granulocytes, the first of 3 consecutive days that the absolute granulocyte count (AGC) exceeded  $500/\mu\text{L}$  and, for platelets, the first of 3 consecutive days that the platelet count exceeded  $20,000/\mu\text{L}$  without transfusion support.

## RESULTS

Clinical characteristics of the 4 patients in this feasibility trial are given in Table 1. Doses of  $\text{CD}34^+$  cells per kilogram of patient body weight for each HSC infusion are given in Table 2. A total of 12 cycles of L-PAM were administered in

**Table 2.** Stem Cell Dose Infused

<i>Patient and Course</i>	<i>CD34<sup>+</sup> Cells, <math>\times 10^6/\text{kg}</math></i>
Patient 1	
1	1.4
2	1.4
3	1.4
Patient 2	
1	1.3
2	0.7
3	1.3
Patient 3	
1	3.0
2	3.0
3	3.0*
Patient 4	
1	1.3*
2	7.6†
3	7.6†

\*Unselected backup cells were given because engraftment was delayed. †Unselected.

**Table 3.** Engraftment Times\*

<i>Patient and Cycle</i>	<i>Day of AGC &gt;500/<math>\mu</math>L</i>	<i>Day of Platelets &gt;20,000/<math>\mu</math>L</i>
<b>Patient 1</b>		
1	12	19
2	12	18
3	11	17
<b>Patient 2</b>		
1	12	17
2	13	NR
3	10	18
<b>Patient 3</b>		
1	NR†	NR
2	NR‡	NR
3	9§	23§
<b>Patient 4</b>		
1	9§	16§
2	9	11
3	9	11

\*AGC, absolute granulocyte count; NR, not reached before next cycle began. †AGC = 410 on day 21; ‡AGC = 212 on day 21; §days after backup product given; ||unselected backup product used.

this feasibility study. Times to recovery of granulocyte and platelet counts for each cycle of L-PAM followed by HSC infusion are given in Table 3.

Only 2 of 12 planned cycles were delayed, none because of low counts. One cycle was delayed 1 week because of a central venous catheter infection that responded to antibiotics; another cycle was delayed 1 week for psychosocial reasons (a death in the family). During the 12 cycles, there were a total of 7 hospital admissions. Five (42%) were for febrile neutropenia that was treated easily with intravenous antibiotics: 1 was for disseminated but minimal herpes zoster infection that responded to treatment with intravenous acyclovir, and 1 was for transient, mild, and spontaneously resolving enteritis coincidentally in a patient who had a prior admission for enteritis from mobilization chemotherapy with cyclophosphamide and prednisone.

The median time to AGC recovery (>500/ $\mu$ L) was 11–12 days, and the median time to platelet recovery (>20,000/ $\mu$ L without transfusion support) was 18 days. During 2 cycles (the third for patient 3 and the first for patient 4), we suspected delayed engraftment (no granulocytes by day 11) and reinfused the backup (unselected) HSC product. For patient 4, unselected HSCs were subsequently used after courses 2 and 3 of L-PAM.



All patients demonstrated disappearance of marrow plasmacytosis. Three of four patients had total resolution of their serum M protein. The fourth patient had a 90% reduction of the M-spike.

## CONCLUSION

L-PAM can be delivered on an outpatient basis with rapid AGC recovery in a space of 9 weeks with acceptable nonhematopoietic organ toxicity. Further, although it was not a primary end point of the study, we noted that none of the cycles of L-PAM were any more complicated (data not shown) than those we observed for mobilization chemotherapy with cyclophosphamide and prednisone, which we routinely give for all patients with hematopoietic malignancies undergoing autologous transplantation. Finally, HSC infusion after the third course of L-PAM provided sufficient hematopoietic reserve for the patients to tolerate immunoconsolidation (data not shown) with  $\alpha$ -interferon or thalidomide in an attempt to prolong the duration of response to dose-dense L-PAM. Clinical responses to date have been gratifying, but follow-up remains too short to be anything more than cautiously optimistic. Long-term survival with this approach remains to be determined.

## REFERENCES

1. Marks PW, Shulman LN. The diagnosis and management of multiple myeloma. *Compr Ther* 21:7-12, 1995.
2. Cunningham D, Paz-Ares L, Gore ME, et al. High-dose melphalan for multiple myeloma: long-term follow-up data. *J Clin Oncol* 12:764-768, 1994.
3. Harousseau J-L, Attal M. Autologous transplantation in multiple myeloma: the IFM experience. In: Dicke KA, Keating A, eds. *Autologous Blood and Marrow Transplantation: Proceedings of the Ninth International Symposium, Arlington, Texas*. Charlottesville, VA: Carden Jennings, 1999, p. 222-230.
4. Anderson KC. Who benefits from high dose therapy for multiple myeloma? *J Clin Oncol* 13:1291-1296, 1995.
5. Schiller G, Vesico R, Freytes C, et al. Transplantation of CD34 positive peripheral blood progenitor cells following high dose chemotherapy for patients with advanced multiple myeloma. *Blood* 86:390-397, 1995.
6. Attal M, Harousseau JL, Stoppa AM, et al. A prospective, randomised trial of autologous bone marrow transplantation and chemotherapy in multiple myeloma. *N Engl J Med* 335:91-97, 1996.
7. Bensinger WI, Rowley SD, Demirer T, et al. High dose therapy followed by autologous hematopoietic stem cell infusion for patients with multiple myeloma. *J Clin Oncol* 14:1447-1456, 1996.
8. Ballester OF, Agaliotis DP, Hiemenz JW, et al. Phase I-II study of high dose busulfan

and cyclophosphamide followed by autologous peripheral blood stem cell transplantation for hematologic malignancies: toxicities and hematopoietic recovery. *Bone Marrow Transplant* 18:9–14, 1996.

9. Harousseau JL, Attal M. The role of autologous stem cell transplantation in multiple myeloma. *Semin Hematol* 34 (Suppl 1):61–66, 1997.
10. Schlossman R, Alyea E, Orsini E, et al. Immune-based strategies to improve hematopoietic stem cell transplantation for multiple myeloma. In: Dicke KA, Keating A, eds. *Autologous Blood and Marrow Transplantation: Proceedings of the Ninth International Symposium, Arlington, Texas*. Charlottesville, VA: Carden Jennings, 1999, p. 207–221.
11. Barlogie B, Jagannath J, Desikan R, et al. Total therapy with tandem transplants for newly diagnosed multiple myeloma. In: Dicke KA, Keating A, eds. *Autologous Blood and Marrow Transplantation: Proceedings of the Ninth International Symposium, Arlington, Texas*. Charlottesville, VA: Carden Jennings, 1999, p. 205–206.

# **CHAPTER 12**

## **HODGKIN'S DISEASE**



# The Role of Sequential Radiation Therapy in High-Dose Therapy Protocols for Hodgkin's Disease

*Richard W. Tsang*

*Department of Radiation Oncology, Princess Margaret Hospital, University Health Network, University of Toronto, Ontario, Canada*

## ABSTRACT

In the treatment of Hodgkin's disease, a significant proportion of patients either fail to attain complete remission with initial therapy or relapse following initial complete response. These patients have a poor prognosis, and high-dose chemotherapy (HDCT) with autologous bone marrow or peripheral blood stem cell support (autoBMT) has become the preferred treatment. Many series report disease-free survival rates of 30%–55% at 4 or 5 years following autoBMT. Although there are no phase 3 data supporting the use of radiation therapy in this setting, many centers incorporate radiation into their high-dose protocols. This is a rational approach based on the radiosensitivity of Hodgkin's disease, which is frequently confined to lymph nodes distributed in a way that is amenable to radiation. There is also a propensity for Hodgkin's disease to recur in previously involved sites, particularly if the disease was bulky.

In selected patients with relapsed Hodgkin's disease following initial chemotherapy, before the routine use of HDCT and autoBMT, treatment with radiation alone resulted in a high response rate, with long-term disease control in ~30% of patients. Thus, chemotherapy failure does not necessarily imply radiation resistance, and there is the opportunity to apply radiation judiciously in sequence with HDCT and autoBMT to improve disease control and survival.

The optimal methods of delivery of radiation (timing, dose, and volume) are not clearly defined. Radiation can be given before autoBMT, either to the involved field or to extended fields up to total nodal irradiation (TNI). The conditioning regimen should not include total body irradiation. This approach pioneered by the Memorial group used TNI to 18 Gy, and the involved sites receive an additional 18 Gy, all delivered within 2 weeks before autoBMT. In Toronto, our approach was wide-field radiation (typically the mantle fields) given within 1–2 months before autoBMT, usually sandwiched between salvage chemotherapy courses. The potential advantages of delivering radiation before autoBMT include maximal cytoreduction before transplant, no delays in instituting radiation (as in after

autoBMT), and avoidance of possible hematologic toxicity if radiation was given after autoBMT. However, because of a high rate of pulmonary toxicity with wide-field thoracic radiation given before autoBMT, we have changed our practice to delivering involved-field radiation after autoBMT. The initial Memorial approach was also associated with a high peritransplant toxicity rate, which has improved with further refinements in their protocol.

The indications for posttransplant radiation therapy include previous bulky disease ( $\geq 5$  cm), disease responding incompletely to salvage chemotherapy, residual abnormalities after autoBMT, and limited-stage disease where the original treatment plan had included radiation therapy. The extent of radiation fields and doses are individualized, depending on prior exposure to radiation, anatomic distribution of the disease, and normal tissue toxicity. Recent technological advances with computed tomography (CT) planning, conformal beam arrangements, and availability of dose-volume histograms for normal organs have expanded the utility and safety of involved-field radiation in the autoBMT setting, particularly for the mediastinal location. Doses of 25–35 Gy are associated with a high rate of in-field control, and minimal short- and long-term toxicity. Several institutional series have reported the benefits of involved-field radiation given after autoBMT. However, prospective studies are urgently needed to define the usefulness of radiation more definitively, its optimal timing in relation to HDCT and autoBMT, and technical parameters such as extent, dose, and fractionation scheme.

## INTRODUCTION

There has been a steady decline in the mortality rate of Hodgkin's disease in the last 2–3 decades, without a significant change in the incidence.<sup>1</sup> This trend is largely attributable to improvements in the treatment of Hodgkin's disease with a risk-adapted approach, consisting of a combination of radiation therapy and chemotherapy, resulting in a high cure rate with initial therapy. However, a significant proportion of patients who either fail induction therapy or relapse after complete response will require high-dose chemotherapy and autologous bone marrow or blood stem cell transplantation. Although the results of autoBMT are superior to conventional-dose salvage chemotherapy in a randomized trial<sup>2</sup> and in retrospective comparative studies,<sup>3–5</sup> the disease-free survival is 30%–55% at 4 or 5 years following autoBMT.<sup>3–19</sup> Because Hodgkin's disease is usually sensitive to radiation, it is possible to improve disease control and survival by incorporating radiation therapy into the high-dose protocol. This article will review the rationale, indications, toxicity, and different methods of using radiation therapy in a planned, sequential manner with autoBMT.

## SENSITIVITY OF HODGKIN'S DISEASE TO RADIATION

The use of radiation therapy has contributed successfully to the management of Hodgkin's disease for more than 50 years. Radiation results in a high cure rate for stage I and II Hodgkin's disease<sup>20</sup> and is often incorporated into combined modality protocols for stage III and IV disease, particularly if there was presence of bulky disease.<sup>21,22</sup> The total dose needed to achieve a high degree of local control ( $\geq 90\%$ ) is in the range of 30–37.5 Gy.<sup>23</sup> A review of the literature showed that above 32 Gy, no dose-response relationship was apparent.<sup>24</sup> There was a suggestion that larger tumors required a higher dose, as logistic regression analysis revealed that the dose required for 95% local control was 27 Gy for subclinical disease, 34 Gy for nodes  $< 6$  cm, and 35 Gy for nodes  $> 6$  cm.<sup>23</sup> A trial comparing 40 vs. 30 Gy prescribed to subclinical disease in early-stage Hodgkin's disease showed equivalent tumor control and survival.<sup>25</sup> When radiation is used in combination with chemotherapy, clinical data suggest that even lower doses are sufficient for local control. In pediatric combined-modality protocols, doses of 15–25 Gy are common and are highly successful.<sup>26,27</sup> In the chemotherapy-refractory or relapse setting, the control rate with radiation is similarly high (see below). Therefore, it appears most logical to use radiation in sequence with salvage chemotherapy and autoBMT to maximize disease control. Dose levels of 25–35 Gy are within tolerance of most internal organs, provided sensitive structures such as lungs, liver, and kidneys are protected.

## RADIATION AS SALVAGE THERAPY AFTER CHEMOTHERAPY FAILURE

Before the routine use of HDCT and autoBMT in the late 1980s, selected patients who failed initial chemotherapy were given radiation therapy as salvage treatment. The techniques used varied from mantle fields to extensive fields up to TNI. A review of the representative institutional series is presented in Table 1.<sup>28–37</sup> Patients were usually selected to receive radiation because the disease at the time of relapse was predominantly localized, nodal, and amenable to coverage with radiation. The in-field control rate was  $\sim 90\%$ , and one third of the patients survived 5 years with control of disease. Patients were more likely to have a durable response if the disease-free interval was  $> 12$  months from completion of initial chemotherapy. Uematsu et al.<sup>32</sup> suggested that the addition of chemotherapy as salvage therapy was superior to radiation alone. Although these data cannot be directly compared with results of HDCT and autoBMT, they nevertheless showed that radiation therapy alone could salvage a small proportion of patients, who would now be routinely considered candidates for autoBMT. It also demonstrated that certain patient characteristics predict for a favorable response to radiation: those with predominantly nodal disease, no systemic symptoms, favorable histology, and a long disease-free interval.<sup>37</sup>

**Table 1.** Refractory/Relapsed Hodgkin's Disease After Chemotherapy: Representative Results With Salvage Radiotherapy (RT) With or Without Chemotherapy (CT)\*

Authors	Year	Reference	No. of Patients		DFI >1 y, %	CR, %	5-y DFS, %	5-y OS, %
			RT	RT+CT				
Mauch et al.	1987	36	12	7	32	63	48	69
Roach et al.	1987	34	13	0	23	93	45†	75†
Lohri et al.	1991	30	11	0	HR	—	17	—
			6	0	LR	—	100	—
Brada et al.	1992	28	25	19	75	66	23‡	40‡
Leigh et al.	1993	29	16	12	32	93	40	63
Uematsu et al.	1993	32	14		50	93	36	36
				14	14	93	93§	85§
Pezner et al.	1994	35	10	0	50	80	30‡	38‡
MacMillan et al.	1994	31	11	0	73	100	44	100
O'Brien and Parnis	1995	33	11	0	73	73	27	45
Wirth et al.	1997	37	50	2	42	45	26	57

\*CR, complete remission; DFI, disease-free interval; DFS, disease-free survival; HR, high risk; LR, low risk; OS, overall survival. †3-y rates; ‡10-y rates; §7-y rates; ||relapsed sites were localized and nodal only.

## HIGH-DOSE THERAPY AND SITES OF RELAPSE

Several investigators have reported on the sites of failure in patients treated with HDCT and autoBMT. Where radiation was used only sparingly or not at all, the majority of relapses occurred in sites of previous involvement. The Vancouver experience described 12 of 13 recurrences located in previously involved sites,<sup>38</sup> similar to that found by other groups: 33 of 49 relapsed in previous sites from the Seattle series,<sup>6</sup> 25 of 32 from Stanford,<sup>39</sup> 12 of 13 from Chicago,<sup>40</sup> and 82% in the Genoa series.<sup>9</sup> Summarizing these data, among patients who relapsed after autoBMT, the relapses occurred in previously involved sites in ~75%–80%. Therefore, there is strong rationale to incorporate radiation therapy to known disease sites in HDCT protocols to improve the disease control rate. With the judicious use of consolidation involved-field radiation therapy (IFRT) in 29 of 86 autoBMT patients at the City of Hope, 2 of 26 patients failed inside the radiation field as a first site of recurrence, ie, a local control rate of 92%.<sup>41</sup> The Vancouver group reported in-field control in 22 of 24 patients given irradiation before autoBMT (local control rate 92%).<sup>38</sup> Mundt et al.<sup>40</sup> reported on 54 patients of whom 20 received IFRT either before or after autoBMT. Of the 41 irradiated sites in the 20 patients, 39 sites were controlled (actuarial 5-year local control rate 80%), with the main benefit derived from patients with nodal sites of disease and those



receiving IFRT for persistent disease after autoBMT.<sup>40</sup> Poen et al.<sup>39</sup> from Stanford reported on the use of IFRT in 24 patients (67 disease sites) given either before or after autoBMT, and local failure occurred in 2 patients (4 sites), ie, local control rate of 92%.

## SEQUENTIAL RADIATION IN HIGH-DOSE PROTOCOLS

### Cytoreductive Radiation Before AutoBMT

One of the main determinants of disease control and survival is the disease status before autoBMT,<sup>10–12,42</sup> with complete-response patients having a better outcome than those with a partial response. Therefore it is tantalizing to use radiation for maximum cytoreduction following incomplete response to salvage chemotherapy. Additional advantages of pretransplant radiation include no delays in instituting radiation (as in post-autoBMT) and, in situations where wide-field radiation (eg, TNI) is desirable, avoidance of the possible hematologic toxicity expected if radiation were given post-autoBMT. The disadvantages of pretransplant radiation may include nonhematologic (eg, mucosal) toxicity, which can be enhanced with salvage chemotherapy given concurrently or sequentially, possibly delaying the transplant. In the case of mediastinal irradiation, there is also a concern with radiation pneumonitis, which usually manifests clinically 1–3 months posttreatment,<sup>43</sup> overlapping with the early posttransplant period of risk, and results in a high risk of pulmonary complications.<sup>18,44</sup>

The integration of extensive radiation, given sequentially and routinely following salvage chemotherapy, has been successfully used by investigators at the Memorial Hospital. Yahalom et al.<sup>19</sup> reported on 47 patients treated with IFRT to 15 Gy and total lymphoid irradiation to 20 Gy followed by HDCT and autoBMT. Radiation was given twice or three times a day. The disease-free survival was 50% at 6.5 years.<sup>19</sup> There was a toxicity death rate of 17%, chiefly due to pulmonary complications.<sup>19,44</sup> More recent refinements of the Memorial protocol used ICE chemotherapy (ifosfamide, carboplatin, and etoposide), and for those who received prior radiation therapy, IFRT to 18–36 Gy with no TNI. For patients who did not receive prior radiation, the IFRT to 18 Gy is followed by TNI to a further 18 Gy, with fractions delivered twice a day, within a 2-week period before HDCT and autoBMT.<sup>45</sup> The treatment-related mortality has decreased to 5% in the more recently treated patients.<sup>45</sup> This approach uses radiation as a systemic total nodal treatment, without having to resort to total body irradiation (TBI). This is a rational approach, because Hodgkin's disease is predominantly a node-based disease. Although early studies have used TBI in the conditioning regimen for some patients,<sup>6,41,46</sup> its use has largely been curtailed because of a higher toxicity profile<sup>47</sup> and the concern that low doses of TBI (8–14 Gy) do not reliably control gross

disease. Investigators at City of Hope have used a combination of salvage chemotherapy, IFRT, HDCT (cyclophosphamide and etoposide), and TBI in 29 patients,<sup>41</sup> reporting a 2-year disease-free survival of 44%, with excellent disease control rate within the IFRT fields. Interstitial pneumonitis was seen in 3 patients (10%), with 3 patients suffering acute fatal complications of autoBMT (10%).

Cytoreductive radiation therapy can also be practiced with regional or involved-field radiation therapy. Typically, the indications are sites of bulky disease ( $\geq 5$  cm) at any time and areas of incomplete response to salvage chemotherapy. The Stanford experience with cytoreductive IFRT given predominantly before autoBMT in 13 of 62 patients showed an advantage for freedom from relapse (IFRT, 100%; no IFRT, 67%;  $P=.04$ ), and disease-free survival (IFRT, 85%; no IFRT, 54%;  $P=.13$ ) at 3 years.<sup>39,48</sup>

The Toronto approach used wide-field regional radiation in an attempt to achieve complete disease control before HDCT and autoBMT. Among 73 patients treated, the 4-year disease-free survival rate was 39%.<sup>11</sup> The initial use of wide-field thoracic radiation was associated with unacceptable pulmonary toxicity in the posttransplant period and therefore abandoned in favor of more limited IFRT or delivering radiation after autoBMT.<sup>18</sup> Similar pulmonary toxicity was also reported by Reece et al.,<sup>38</sup> with thoracic IFRT given to autoBMT patients conditioned with cyclophosphamide, carmustine, and etoposide (CBV); 8 of 42 patients (19%) developed interstitial pneumonitis with a high fatality rate.

### **Radiation Therapy After AutoBMT**

The indications for post-autoBMT radiation therapy include the presence of previous bulky disease ( $\geq 5$  cm), disease responding incompletely to salvage chemotherapy, residual abnormalities after autoBMT, and limited-stage disease where the original treatment plan had included radiation therapy. Many investigators currently prefer to use IFRT posttransplant to minimize the risk of pulmonary complications if the site of irradiation includes the mediastinum. This strategy also ensures no delay in instituting HDCT and autoBMT, because time spent in conventional fractionated IFRT pretransplant may put the patient at risk for progression of disease outside of the radiation field. Radiation should be started within 3–4 months after autoBMT, upon hematologic recovery with neutrophils  $>2 \times 10^9/L$  and platelets  $>100 \times 10^9/L$ . When these criteria are met, tolerance to treatment is excellent, with a low probability of treatment interruption necessitated by myelosuppression.<sup>49–51</sup> Neutrophil count can be supported by growth factors,<sup>52,53</sup> so the main limiting factor is thrombocytopenia,<sup>51,52</sup> until an effective thrombopoietin becomes routinely available.

Mundt et al.<sup>40</sup> from the University of Chicago reported on their experience of using IFRT in 20 patients, among 54 patient transplanted. Thirteen patients had

radiation posttransplant, and among them, the indication for IFRT was persistent disease after autoBMT in 10 patients. All 10 patients achieved complete response, and their 5-year DFS was 40%, superior to the 12% in the group of 11 patients with persistent disease not receiving IFRT ( $P=.04$ ).<sup>40</sup> Although comparison in such a small number of patients is flawed, it is interesting to note that IFRT can induce further responses in patients with residual abnormalities after autoBMT.

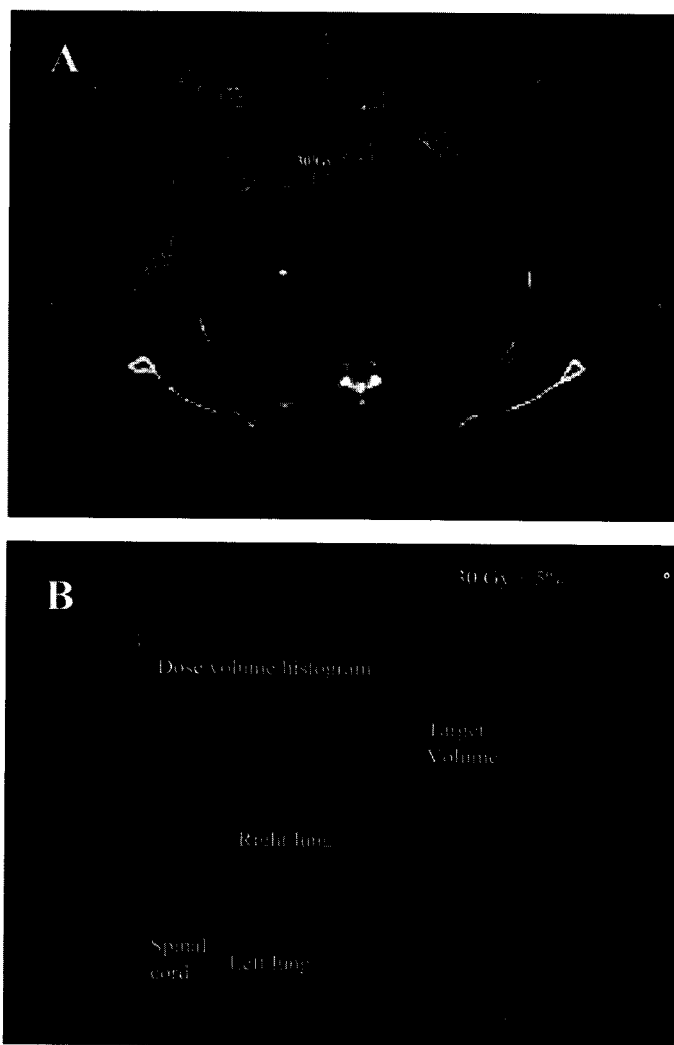
Finally, Lancet et al.<sup>14</sup> reported the results of autoBMT in 70 patients treated at the University of Rochester. Posttransplant IFRT was administered to 27 patients, with the delivery of 20 Gy for patients in complete response assessed before autoBMT and 30 Gy for those in partial response. They observed a 5-year DFS of 44% in the IFRT group, vs. 26% in the nonirradiated group ( $P=.006$ ).<sup>14</sup> A similar trend existed for subgroups of patients with either minimal disease pretransplant (defined as tumor bulk  $\leq 2$  cm) or more bulky disease.

Recent technological advances with CT planning, conformal beam arrangements, and availability of dose-volume histograms for normal organs have expanded the utility and safety of IFRT in the autoBMT setting, particularly for the mediastinal location. For example, it is possible to re-treat regions of persistent disease posttransplant despite prior remote exposure to radiation therapy (Figure 1). Presently, the approach in Toronto adopts posttransplant IFRT, within a period of 2–3 months following autoBMT, using doses of 25–35 Gy, depending on prior exposure to radiation therapy and the irradiated volume. The indications for therapy are as discussed in the beginning of this section.

## UNANSWERED QUESTIONS OPEN TO FURTHER INVESTIGATION

The benefits of incorporating radiation therapy in high-dose therapy protocols for Hodgkin's disease seems intuitive, but the data are based on retrospective analysis of a small number of patients. Comparisons of irradiated and unirradiated patients are inherently flawed by the presence of confounding factors affecting the decision to give the therapy: prior radiation therapy, nodal versus extranodal site, bulk, performance status, and anticipated tolerance to radiation. Furthermore, the optimal timing, dose, and volume of radiation are not clearly defined. Therefore, prospective studies are urgently needed to define the usefulness of radiation more definitively, its optimal timing in relation to HDCT and autoBMT, and technical parameters such as extent, dose, and fractionation scheme.

Progress has been made in the last decade documenting the usefulness of radiation in contributing to disease control within the radiation field and the methods to avoid serious acute toxicity. Further follow-up of patients to define late toxicity is required. The possible contribution of radiation to the increased risk of second cancers, particularly the risk of acute myeloid leukemia/myelodysplastic syndrome (AML/MDS), is a concern. A French study compared the second cancer



**Figure 1.** A 54-year-old man diagnosed 4 years ago with nodular sclerosis Hodgkin's disease, stage 2A, massive mediastinal disease (mediastinal/thoracic ratio, 16:31). Treated with ABVD (doxorubicin, bleomycin, vinblastine, and dacarbazine)  $\times$  8 cycles and mediastinal radiation 30 Gy, this patient achieved complete remission with residual mediastinal abnormality. The patient relapsed in mediastinum 3 years after completion of therapy and was treated with mini-BEAM (BCNU, etoposide, cytosine arabinoside, and melphalan)  $\times$  2 cycles and high-dose chemotherapy with autologous bone marrow transplantation. A, Posttransplant involved-field radiation therapy, with conformal computed tomography planning for a further 30 Gy to gross residual disease. The beam directions, shielding blocks, and isodose distribution are illustrated. B, Dose volume histogram for target and right and left lungs. Note that only 15% of the right lung received >20 Gy, and <5% of the left lung received >8 Gy. The patient tolerated treatment well, with no clinical pulmonary toxicity.

incidence in 367 grafted patients and 1179 conventionally treated patients.<sup>54</sup> Although an increased risk was found in the autoBMT group (5-year actuarial risk, 8.9% for all second cancers, 4.3% for AML/MDS), the use of radiation or its extent (limited or extensive) was not prognostic for the development of AML/MDS.<sup>54</sup> In contrast, a recent case-control study of 22 patients who developed AML/MDS (among 612 lymphoma patients treated with autoBMT) revealed an association with etoposide used for stem cell mobilization and pretransplant radiation (relative risk 2.5; 95% confidence interval, 0.9–7.3).<sup>55</sup> Whether the use of limited IFRT in association with autoBMT results in a significant increase in the risk of second cancers, including AML/MDS, requires further study and diligent long-term follow-up.

## REFERENCES

1. Aisenberg AC. Problems in Hodgkin's disease management. *Blood* 93:761–779, 1999.
2. Linch DC, Winfield D, Goldstone AH, et al. Dose intensification with autologous bone-marrow transplantation in relapsed and resistant Hodgkin's disease: results of a BNLI randomised trial. *Lancet* 341:1051–1054, 1993.
3. Anselmo AP, Meloni G, Cavalieri E, et al. Conventional salvage chemotherapy vs. high-dose therapy with autografting for recurrent or refractory Hodgkin's disease patients. *Ann Hematol* 79:79–82, 2000.
4. Andre M, Henry-Amar M, Pico JL, et al. Comparison of high-dose therapy and autologous stem-cell transplantation with conventional therapy for Hodgkin's disease induction failure: a case-control study. Societe Francaise de Greffe de Moelle. *J Clin Oncol* 17:222–229, 1999.
5. Yuen AR, Rosenberg SA, Hoppe RT, Halpern JD, Horning SJ. Comparison between conventional salvage therapy and high-dose therapy with autografting for recurrent or refractory Hodgkin's disease. *Blood* 89:814–822, 1997.
6. Anderson JE, Litzow MR, Appelbaum FR, et al. Allogeneic, syngeneic and autologous marrow transplantation for Hodgkin's disease: the 21 year Seattle experience. *J Clin Oncol* 11:2342–2350, 1993.
7. Armitage JO, Bierman PJ, Vose JM, et al. Autologous bone marrow transplantation for patients with relapsed Hodgkin's disease. *Am J Med* 91:605–611, 1991.
8. Brice P, Bouabdallah R, Moreau P, et al. Prognostic factors for survival after high-dose therapy and autologous stem cell transplantation for patients with relapsing Hodgkin's disease: analysis of 280 patients from the French registry. *Bone Marrow Transplant* 20:21–26, 1997.
9. Carella AM, Congiu AM, Gaozza E, et al. High-dose chemotherapy with autologous bone marrow transplantation in 50 advanced resistant Hodgkin's disease patients: an Italian study group report. *J Clin Oncol* 6:1411–1416, 1988.
10. Chopra R, McMillan AK, Linch DC, et al. The place of high-dose BEAM therapy and autologous bone marrow transplantation in poor-risk Hodgkin's disease: a single-center eight-year study of 155 patients. *Blood* 81:1137–1145, 1993.

11. Crump M, Smith AM, Brandwein J, et al. High-dose etoposide and melphalan, and autologous bone marrow transplantation for patients with advanced Hodgkin's disease: importance of disease status at transplant. *J Clin Oncol* 11:704–711, 1993.
12. Horning SJ, Chao NJ, Negrin RS, et al. High-dose therapy and autologous hematopoietic progenitor cell transplantation for recurrent or refractory Hodgkin's disease: analysis of the Stanford University results and prognostic indices. *Blood* 89:801–813, 1997.
13. Kessinger A, Bierman PJ, Vose JM, Armitage JO. High-dose cyclophosphamide, carmustine, and etoposide followed by autologous peripheral stem cell transplantation for patients with relapsed Hodgkin's disease. *Blood* 77:2322–2325, 1991.
14. Lancet JE, Rapoport AP, Brasacchio R, et al. Autotransplantation for relapsed or refractory Hodgkin's disease: long-term follow-up and analysis of prognostic factors. *Bone Marrow Transplant* 22:265–271, 1998.
15. Reece DE, Barnett MJ, Shepherd JD, et al. High-dose cyclophosphamide, carmustine (BCNU), and etoposide (VP16-213) with or without cisplatin (CBV + P) and autologous transplantation for patients with Hodgkin's disease who fail to enter a complete remission after combination chemotherapy. *Blood* 86:451–456, 1995.
16. Sweetenham JW, Taghipour G, Milligan D, et al. High-dose therapy and autologous stem cell rescue for patients with Hodgkin's disease in first relapse after chemotherapy: results from the EBMT. Lymphoma Working Party of the European Group for Blood and Marrow Transplantation. *Bone Marrow Transplant* 20:745–752, 1997.
17. Sweetenham JW, Carella AM, Taghipour G, et al. High-dose therapy and autologous stem-cell transplantation for adult patients with Hodgkin's disease who do not enter remission after induction chemotherapy: results in 175 patients reported to the European Group for Blood and Marrow Transplantation. Lymphoma Working Party. *J Clin Oncol* 17:3101–3109, 1999.
18. Tsang RW, Gospodarowicz MK, Sutcliffe SB, Crump M, Keating A. Thoracic radiation therapy before autologous bone marrow transplantation in relapsed or refractory Hodgkin's disease. PMH Lymphoma Group and the Toronto Autologous BMT Group. *Eur J Cancer* 35:73–78, 1999.
19. Yahalom J, Gulati SC, Toia M, et al. Accelerated hyperfractionated total-lymphoid irradiation, high-dose chemotherapy, and autologous bone marrow transplantation for refractory and relapsing patients with Hodgkin's disease. *J Clin Oncol* 11:1062–1070, 1993.
20. Gospodarowicz MK, Sutcliffe SB, Clark RM, et al. Analysis of supradiaphragmatic clinical stage I and II Hodgkin's disease treated with radiation alone. *Int J Radiat Oncol Biol Phys* 22:859–865, 1992.
21. Fabian CJ, Mansfield CM, Dahlberg S, et al. Low-dose involved field radiation after chemotherapy in advanced Hodgkin disease: a Southwest Oncology Group randomized study. *Ann Intern Med* 120:903–912, 1994.
22. Diehl V, Franklin J, Hasenclever D, et al. BEACOPP: a new regimen for advanced Hodgkin's disease. German Hodgkin's Lymphoma Study Group. *Ann Oncol* 9 (Suppl 5):S67–S71, 1998.
23. Vijayakumar S, Myriantopoulos LC. An updated dose-response analysis in Hodgkin's disease. *Radiother Oncol* 24:1–13, 1992.
24. Brincker H, Bentzen SM. A re-analysis of available dose-response and time-dose data in

- Hodgkin's disease. *Radiother Oncol* 30:227–230, 1994.
25. Duhmke E, Diehl V, Loeffler M, et al. Randomized trial with early-stage Hodgkin's disease testing 30 Gy vs. 40 Gy extended field radiotherapy alone. *Int J Radiat Oncol Biol Phys* 36:305–310, 1996.
  26. Hudson MM, Donaldson SS. Treatment of pediatric Hodgkin's lymphoma. *Semin Hematol* 36:313–323, 1999.
  27. Potter R. Paediatric Hodgkin's disease. *Eur J Cancer* 35:1466–1474; discussion 1474–1466, 1999.
  28. Brada M, Eeles R, Ashley S, Nichols J, Horwich A. Salvage radiotherapy in recurrent Hodgkin's disease. *Ann Oncol* 3:131–135, 1992.
  29. Leigh BR, Fox KA, Mack CF, Baier M, Miller TP, Cassady JR. Radiation therapy salvage of Hodgkin's disease following chemotherapy failure. *Int J Radiat Oncol Biol Phys* 27:855–862, 1993.
  30. Lohri A, Barnett M, Fairey RN, et al. Outcome of treatment of first relapse of Hodgkin's disease after primary chemotherapy: identification of risk factors from the British Columbia experience 1970 to 1988. *Blood* 77:2292–2298, 1991.
  31. MacMillan CH, Bessell EM. The effectiveness of radiotherapy for localized relapse in patients with Hodgkin's disease (IIB-IVB) who obtained a complete response with chemotherapy alone as initial treatment. *Clin Oncol (R Coll Radiol)* 6:147–150, 1994.
  32. Uematsu M, Tarbell NJ, Silver B, et al. Wide-field radiation therapy with or without chemotherapy for patients with Hodgkin disease in relapse after initial combination chemotherapy. *Cancer* 72:207–212, 1993.
  33. O'Brien P, Parnis FX. Salvage radiotherapy following chemotherapy failure in Hodgkin's disease—what is its role? *Acta Oncol* 34:99–104, 1995.
  34. Roach MI, Kapp DS, Rosenberg SA, Hoppe RT. Radiotherapy with curative intent: an option in selected patients relapsing after chemotherapy for advanced Hodgkin's disease. *J Clin Oncol* 5:550–555, 1987.
  35. Pezner RD, Lipsett JA, Vora N, Forman SJ. Radical radiotherapy as salvage treatment for relapse of Hodgkin's disease initially treated by chemotherapy alone: prognostic significance of the disease-free interval. *Int J Radiat Oncol Biol Phys* 30:965–970, 1994.
  36. Mauch P, Tarbell N, Skarin A, Rosenthal D, Weinstein H. Wide-field radiation therapy alone or with chemotherapy for Hodgkin's disease in relapse from combination chemotherapy. *J Clin Oncol* 5:544–549, 1987.
  37. Wirth A, Corry J, Laidlaw C, Matthews J, Liew KH. Salvage radiotherapy for Hodgkin's disease following chemotherapy failure. *Int J Radiat Oncol Biol Phys* 39:599–607, 1997.
  38. Reece DE, Barnett MJ, Connors JM, et al. Intensive chemotherapy with cyclophosphamide, carmustine, and etoposide followed by autologous bone marrow transplantation for relapsed Hodgkin's disease. *J Clin Oncol* 9:1871–1879, 1991.
  39. Poen JC, Hoppe RT, Horning SJ. High-dose therapy and autologous bone marrow transplantation for relapsed/refractory Hodgkin's disease: the impact of involved field radiotherapy on patterns of failure and survival. *Int J Radiat Oncol Biol Phys* 36:3–12, 1996.
  40. Mundt AJ, Sibley G, Williams S, Hallahan D, Nautiyal J, Weichselbaum RR. Patterns of failure following high-dose chemotherapy and autologous bone marrow transplantation with involved field radiotherapy for relapsed/refractory Hodgkin's disease. *Int J Radiat*

- Oncol Biol Phys* 33:261–270, 1995.
41. Pezner RD, Nademanee A, Niland JC, Vora N, Forman SJ. Involved field radiation therapy for Hodgkin's disease autologous bone marrow transplantation regimens. *Radiother Oncol* 34:23–29, 1995.
  42. Jagannath S, Armitage JO, Dicke KA, et al. Prognostic factors for response and survival after high-dose cyclophosphamide, carmustine, and etoposide with autologous bone marrow transplantation for relapsed Hodgkin's disease. *J Clin Oncol* 7:179–185, 1989.
  43. McDonald S, Rubin P, Phillips TL, Marks LB. Injury to the lung from cancer therapy: clinical syndromes, measurable endpoints, and potential scoring systems. *Int J Radiat Oncol Biol Phys* 31:1187–1203, 1995.
  44. Jules-Elysee K, Stover DE, Yahalom J, White DA, Gulati SC. Pulmonary complications in lymphoma patients treated with high-dose therapy and autologous bone marrow transplantation. *Am Rev Respir Dis* 146:485–491, 1992.
  45. Yahalom J. Integrating radiotherapy into bone marrow transplantation programs for Hodgkin's disease. *Int J Radiat Oncol Biol Phys* 33:525–528, 1995.
  46. Horning SJ, Negrin RS, Chao NJ, Long GD, Hoppe RT, Blume KG. Fractionated total-body irradiation, etoposide, and cyclophosphamide plus autografting in Hodgkin's disease and non-Hodgkin's lymphoma. *J Clin Oncol* 12:2552–2558, 1994.
  47. Pecego R, Hill R, Appelbaum FR, et al. Interstitial pneumonitis following autologous bone marrow transplantation. *Transplantation* 42:515–517, 1986.
  48. Hoppe RT. Radiation therapy as a component of high-dose salvage strategies in Hodgkin's disease. *Ann Oncol* 9 (Suppl 5):S87–S90, 1998.
  49. Bogart JA, Ungureanu C, Ryu S, Chung CT, Zamkoff KW. Hematologic toxic reaction to radiation therapy adjuvant to autologous peripheral blood stem cell transplantation for recurrent or refractory Hodgkin disease. *Radiology* 214:421–425, 2000.
  50. Price A, Cunningham D, Horwich A, Brada M. Haematological toxicity of radiotherapy following high-dose chemotherapy and autologous bone marrow transplantation in patients with recurrent Hodgkin's disease. *Eur J Cancer* 30A:903–907, 1994.
  51. Abrams RA, Liu PJ, Ambinder RF, et al. Hodgkin and non-Hodgkin lymphoma: local-regional radiation therapy after bone marrow transplantation. *Radiology* 203:865–870, 1997.
  52. Adamietz IA, Rosskopf B, Dapper FD, von Lieven H, Boettcher HD. Comparison of two strategies for the treatment of radiogenic leukopenia using granulocyte colony stimulating factor. *Int J Radiat Oncol Biol Phys* 35:61–67, 1996.
  53. Knox SJ, Fowler S, Marquez C, Hoppe RT. Effect of filgrastim (G-CSF) in Hodgkin's disease patients treated with radiation therapy. *Int J Radiat Oncol Biol Phys* 28:445–450, 1994.
  54. Andre M, Henry-Amar M, Blaise D, et al. Treatment-related deaths and second cancer risk after autologous stem-cell transplantation for Hodgkin's disease. *Blood* 92: 1933–1940, 1998.
  55. Krishnan A, Bhatia S, Slovak ML, et al. Predictors of therapy-related leukemia and myelodysplasia following autologous transplantation for lymphoma: an assessment of risk factors. *Blood* 95:1588–1593, 2000.



# The Importance of Salvage Chemotherapy Before High-Dose Therapy and Stem Cell Transplantation for Patients With Relapsed or Refractory Hodgkin's Disease

*Michael Crump, Todd Roberts, Armand Keating*

*Department of Medical Oncology and Hematology, Princess Margaret Hospital and the University of Toronto, Toronto, Ontario, Canada*

## ABSTRACT

High-dose therapy with autologous stem cell transplantation (autoSCT) is accepted as the treatment of choice for patients with Hodgkin's disease that does not respond to or has relapsed after anthracycline-based chemotherapy. Twenty-five to fifty percent of such patients will be disease free 5–10 years after autoSCT. Chemotherapy sensitivity—defined by response to standard-dose salvage chemotherapy before autoSCT—is one of the most important predictors of long-term outcome. In 194 patients with relapsed or refractory Hodgkin's disease treated at the Toronto General Hospital from 1986 to 1998, the 10-year event-free survival (EFS) is 28%, and overall survival (OS) is 30%. Among those with a complete response to salvage therapy, EFS is 68% at 5 years and 42% at 10 years; OS is 83% and 48%, respectively. The corresponding rates for those with only a partial response to therapy are 24% and 20% for EFS and 28% and 18% for OS ( $P < .001$ , log-rank test). Multivariate analysis of a number of potential prognostic variables—response to salvage therapy (complete response [CR] vs. partial response [PR]), duration of initial CR, B symptoms, relapse in a previous radiation field, number of relapses, and number of cycles of salvage therapy received—showed that only disease status at the time of autoSCT was predictive of outcome. The risk of secondary acute myeloid leukemia (AML)/myelodysplastic syndrome (MDS) in this cohort is 11% at 10 years. Response to salvage chemotherapy identifies a subset of patients with relapsed/refractory Hodgkin's disease who have a high likelihood of cure after autoSCT; such patients should be enrolled in studies focusing on minimizing long-term toxicity. On the other hand, patients with only a partial response have a high risk of subsequent disease progression and death from Hodgkin's disease. Studies to reduce the relapse rate in this patient population—

through additional local, systemic, immunologic, or other therapy—remain a priority.

## INTRODUCTION

High-dose chemotherapy with autologous bone marrow or peripheral blood stem cell support (autoSCT) is an accepted therapy for patients with Hodgkin's disease that has failed to respond to or relapsed after primary chemotherapy with ABVD (doxorubicin, bleomycin, vinblastine, and dacarbazine) or equivalent regimens. This acceptance is based on the superior outcome after autoSCT for patients considered to be induction failures (progression  $\leq 3$  months of completing chemotherapy),<sup>1-4</sup> as well as patients who had at least one prior CR and then recurred, compared with historical controls.<sup>5</sup> Two randomized trials from the British National Lymphoma Investigation (BNLI)<sup>6</sup> and the German Hodgkin's Disease Study Group<sup>7</sup> have also shown a significant improvement in progression-free survival (PFS) in relapsed and refractory patients sensitive to salvage chemotherapy; however, neither study has shown a survival difference between autoSCT and conventional-dose salvage chemotherapy to date.

Most information about the value of high-dose therapy in Hodgkin's disease comes from large, single-institution or bone marrow transplant registry retrospective analyses.<sup>8-12</sup> Hence, a number of variables—including patient selection— influences the results that have been reported. These analyses have been very important in suggesting patient characteristics that can predict a more or less favorable outcome, as well as defining the short- and long-term complications following this therapy.<sup>8,13-16</sup> Although the use of peripheral blood stem cells has resulted in more prompt engraftment and shorter hospitalization, the risk of treatment-related mortality at 3 to 12 months after autoSCT is significant, ranging from 2 to 20%. In addition, a number of centers have observed an increase in secondary myeloid malignancies (AML and MDS) following autoSCT for Hodgkin's disease.<sup>17,18</sup> Therefore, it is very important for the clinician to be able to predict which patients would be expected to benefit from this therapy and to identify those for whom the short-term morbidity and mortality and long-term risks of therapy cannot be justified on the basis of cause-specific survival.

In Hodgkin's disease, as has been shown in non-Hodgkin's lymphoma, chemotherapy sensitivity—defined variably as the regression of tumor masses and improvement in symptoms using conventional-dose chemotherapy—has emerged as an important predictor of outcome following high-dose therapy and autoSCT. In fact, in our experience with more than 200 patients treated in a uniform fashion at the University of Toronto, the use of salvage therapy and careful restaging before autoSCT has revealed that disease status at the time of high-dose therapy is the most important predictor of long-term disease-free and overall survival in this

treatment setting. These data, as well as other data from the published literature, are reviewed here to illustrate the importance of the use of conventional-dose salvage therapy before transplant in determining outcome.

### THE TORONTO EXPERIENCE WITH HIGH-DOSE CHEMOTHERAPY FOR HODGKIN'S DISEASE

From December 1986 to August 1998, 194 patients with refractory or relapsed Hodgkin's disease were treated with high-dose chemotherapy and autoSCT at the Toronto General Hospital. Patients were considered eligible if they had Hodgkin's disease that was recurrent after a complete remission following doxorubicin-based chemotherapy or that did not respond to primary chemotherapy (defined as progression during chemotherapy or within 3 months of completion). All patients demonstrated sensitivity to salvage chemotherapy before proceeding to transplant, defined as at least a 50% reduction in the sum of the cross-sectional area of bidimensionally measurable lesions along with resolution of disease-related symptoms. Salvage chemotherapy consisted of either mini-BEAM (carmustine [BCNU], etoposide, cytosine arabinoside, and melphalan) or DHAP (dexamethasone, cytosine arabinoside, and cisplatin) for at least 2 cycles or to maximum tumor response.<sup>19,20</sup> All patients were completely restaged immediately before transplant to determine disease status at transplant and to facilitate evaluation of response to the high-dose regimen. Restaging included computed tomography of the thorax, abdomen, and pelvis, as well as bone marrow biopsy, plain chest radiographs, bone scan, and a gallium scan if any of these had been positive at relapse. Response definitions have been described.<sup>8</sup>

High-dose therapy consisted of etoposide 60 mg/kg in 5 to 6 liters of normal saline infused over 5 hours on day -4 and melphalan 140-160 mg/m<sup>2</sup> administered as an intravenous bolus over 30 minutes on day -3. Cryopreserved autologous bone marrow and/or peripheral blood stem cells were infused on day 0. Details of the patients' supportive care regimen have been described.<sup>8</sup> Following hematopoietic recovery and resolution of nonhematologic toxicity, areas of bulk disease >5 cm at relapse were treated with involved-field radiation, 35 Gy in 20 fractions if normal tissue tolerance was not exceeded.<sup>21</sup>

#### Patients

The characteristics of the 194 patients at the time of referral for transplant are listed in Table 1. The median age was 31 years (range, 16-61 years). An approximately equal number of patients had a previous complete remission lasting  $\geq 1$  year or <1 year from the completion of primary chemotherapy. One-half of the patients were treated at the time of first relapse from chemotherapy, and 10% had disease that was refractory to primary chemotherapy (induction failures). The median time

**Table 1.** Patient Characteristics\*

Patients, <i>n</i>	194
Median age, y (range)	31 (16–61)
Sex, M/F	62/38
B symptoms at diagnosis†	49
Histology	
Nodular sclerosis	78
Mixed cellularity	15
Lymphocyte predominant	4
Stage at diagnosis	
I or II	42
III or IV	58
Disease status at transplant	
Complete remission	40
Partial remission	60
Number of relapses	
Refractory	10
1	52
2	21
≥3	17
Initial radiotherapy	38
Salvage radiotherapy	31
Relapse in radiation field	31
Duration of CR1	
Refractory	10
<1 year	37
≥1 year	41
Unknown	11

\*Data are % unless otherwise indicated. †B symptoms are systemic symptoms such as weight loss and night sweats.

from original diagnosis to transplant was 2.7 years (range, 0.8–22 years). Forty percent of patients were judged to have had a complete response to maximum salvage chemotherapy before transplant, and 60%, a partial response.

### Treatment Outcome

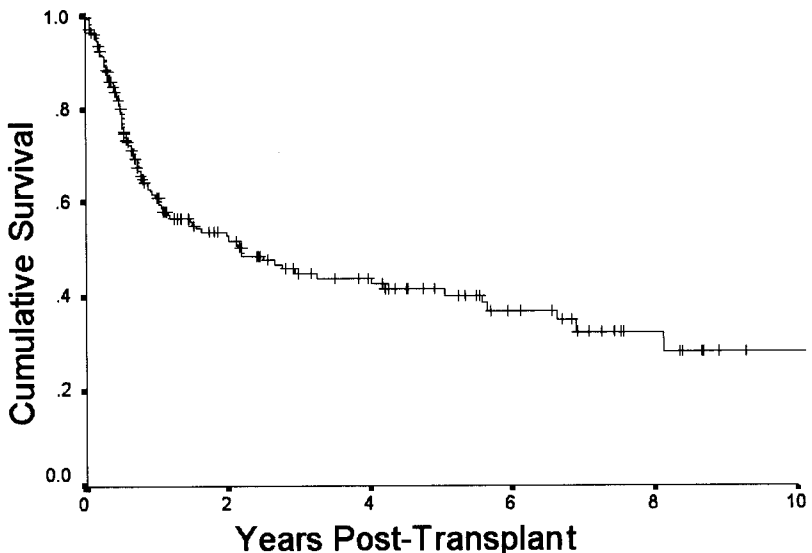
The median follow-up of surviving patients is 60 months (range, 8–132 months). There were 11 deaths (5.6%) from toxicity within the first 100 days after autoSCT; treatment-related mortality at 1 year was 7.7%. Seventy-seven patients (40%) have relapsed posttransplant, with a median time to relapse of 8 months (range, 1 month to 4.9 years). No relapses have been observed >5 years posttransplant.

Event-free survival for all patients is 40% at 5 years and 28% at 10 years, with a median EFS of 2.2 years (95% confidence interval [CI], 1.2–3.2) (Figure 1). Overall survival for the entire cohort of patients is 48% at 5 years and 30% at 10 years, with a median OS of 4.7 years (95% CI, 3.3–6.2) (Figure 2).

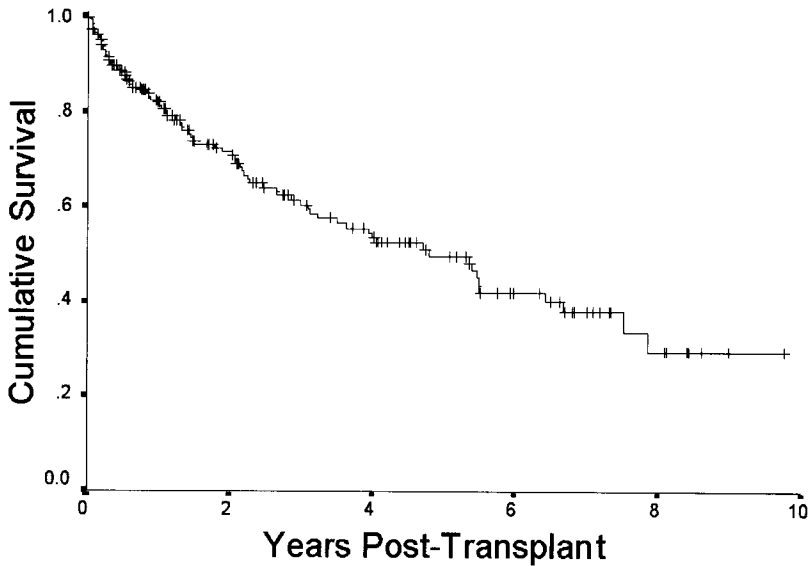
### Predictors of Outcome Posttransplant

A Cox proportional hazards model was used to model EFS and OS as a function of a number of prognostic variables measured before transplant. The variables analyzed were duration of CR1 ( $\geq 1$  vs.  $< 1$  year), B symptoms (systemic symptoms such as weight loss and night sweats), stage at diagnosis, number of relapses before transplant (1 vs.  $> 1$ ), pathological subtype (nodular sclerosis vs. mixed cellularity vs. lymphocyte predominant), response to primary treatment (CR vs. PR vs. refractory), number of cycles of salvage chemotherapy ( $\geq 3$  vs.  $< 3$ ), relapse in a previously irradiated site, and disease status at time of high-dose therapy (CR vs. PR).

By univariate analysis, disease status at the time of transplant, duration of CR1, and number of cycles of salvage chemotherapy were significant predictors of EFS ( $P=.0001$ , .03, and .0007, respectively). Disease status at time of transplant and number of cycles of salvage chemotherapy before transplant were significant predictors of OS ( $P=.0001$  and .0007, respectively). There was a trend for patients who had relapsed in a previous radiation field to have worse EFS ( $P=.06$ ). B symptoms, number of relapses before transplant, pathological



**Figure 1.** Event-free survival.



**Figure 2.** Overall survival.

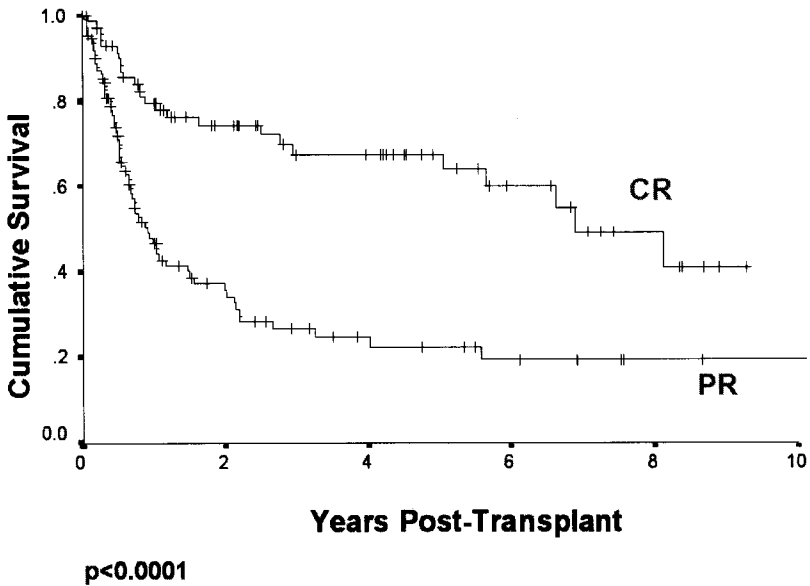
subtype, and duration of CR1 (<1 vs.  $\geq 1$  year) did not have a significant influence on outcome.

In multivariate analysis, the only significant predictor of both EFS and OS was disease status at the time of transplant ( $P < .0001$  for both). Patients transplanted in CR after salvage chemotherapy had an EFS of 68% at 5 years and 42% at 10 years; for patients transplanted in PR, EFS was 24% and 20%, respectively (Figure 3). Median EFS was 6.9 years (95% CI, 4.5–9.3) for those transplanted in CR vs. 0.9 years (0.6–1.2) for those transplanted in PR ( $P < .0001$ ). Median survival for patients transplanted in CR following salvage chemotherapy was significantly longer than for patients transplanted in PR (7.9 [95% CI, 6.2–9.5] vs. 2.5 years [95% CI, 1.7–3.2],  $P < .0001$ ). Overall survival for patients in CR at the time of transplant was 83% at 5 years and 48% at 10 years; for those transplanted in PR, survival was 28% and 20%, respectively ( $P < .0001$ ) (Figure 4).

At the time of this analysis, 78 of 194 patients (40%) have died. Death from causes other than recurrent Hodgkin's disease (treatment-related toxicity and secondary malignancies) account for 28 of these deaths (36%).

### Secondary Malignancies

There have been a total of 11 secondary malignancies observed in this cohort posttransplant: 6 cases of AML, 3 MDS, 1 non-small-cell lung cancer, and 1 non-

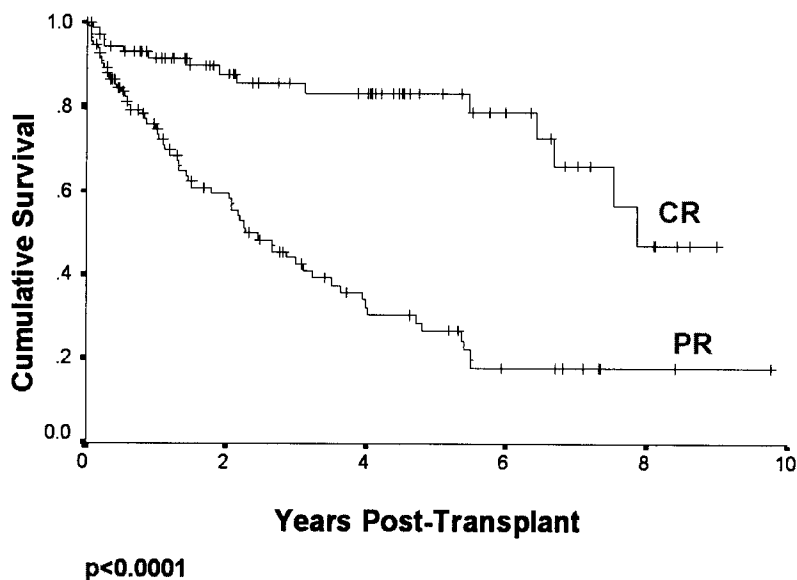


**Figure 3.** Event-free survival by disease status at transplant.

Hodgkin's lymphoma. The median time to onset of MDS/AML from the date of transplant was 3.0 years (range, 1.0–5.9 years), and from the time of first chemotherapy, 7.1 years (range, 3.0–12.8 years). Eight of 9 patients had abnormal bone marrow cytogenetics, including deletions of all or part of chromosomes 5 or 7 or both in 5 patients and abnormalities involving chromosome 11q23 in 2 patients. Using competing risk methods, the cumulative incidence of MDS/AML in this series of patients is 11.5% at 10 years. There was no relationship between the number of cycles of salvage therapy received and the risk of developing secondary MDS/AML in our patient population.

## DISCUSSION

A number of series of patients with relapsed or refractory Hodgkin's disease have shown that response to salvage chemotherapy is a major determinant of response rate, progression-free survival, and overall survival after autoSCT.<sup>13,16,21,22</sup> In addition, pretreatment characteristics such as disease bulk, performance status, B symptoms at relapse, duration of initial remission, extranodal disease at relapse and number of previous treatments have been noted by many authors to have an impact on outcome.<sup>8–15,22,23</sup> There is, however, marked variation between these case series in terms of referral patterns, patient characteristics, definition of many of the prognostic variables mentioned above, and the high-dose regimen used.



**Figure 4.** Overall survival by disease status at transplant.

Prognostic models predictive of outcome have been developed by a number of investigators to guide treatment recommendations and identify patients for whom alternative or more aggressive therapy may be appropriate. In general, these models have identified extent of disease after salvage therapy as being important in predicting long-term outcome.<sup>5,13,15</sup> Favorable outcome is associated in these models with lack of disease progression with salvage chemotherapy,<sup>15</sup> CR or PR to most recent chemotherapy,<sup>13</sup> or the achievement of a minimal disease state after salvage with MOPP (mechlorethamine, vincristine, procarbazine, and prednisone) or DHAP.<sup>5</sup> On the other hand, patients with Hodgkin's disease that is refractory to salvage chemotherapy have a much worse outcome.<sup>2,10,13,24</sup> For example, Chopra et al.<sup>10</sup> reported PFS at 5 years of 52% among 33 patients with chemotherapy-sensitive relapse following autoSCT with BEAM, compared with 32% in patients with chemoresistant disease. In the analysis of adults with Hodgkin's disease that did not go into remission following initial anthracycline-based chemotherapy reported to the European Group for Blood and Marrow Transplantation (EBMT),<sup>2</sup> the outcome of patients who also progressed or did not respond to second-line therapy was significantly worse than those who went straight to autoSCT; the latter group presumably included some patients who would have been judged to be chemotherapy sensitive had they, too, had additional chemotherapy.

Some authors have reported superior results for patients with relapsed Hodgkin's disease who were transplanted in "untested" relapse, compared with



those who actually received salvage therapy first. Chopra et al.<sup>10</sup> reported that among 155 patients treated at University College Hospital, 5-year PFS was 78% for patients who proceeded directly to autoSCT with BEAM without receiving conventional salvage therapy at time of latest relapse. This was significantly better than those who were chemotherapy sensitive or chemoresistant (<50% response) at transplant. In a smaller series of patients, Bierman et al.<sup>14</sup> reported failure-free survival of 90% for 10 patients who proceeded directly to transplant without salvage compared with 33% for 75 patients who received conventional salvage chemotherapy before transplant ( $P=.016$ ).

What could account for the apparent superior outcome for patients with untested relapse? One argument is that salvage chemotherapy induces drug resistance, even to high-dose therapy. This is possible but seems unlikely given the consistently superior results observed when a minimal disease state or CR is obtained with chemotherapy before autoSCT; if drug resistance is induced by salvage therapy, it should be seen in both PR and CR patients, who have about the same amount of disease before salvage and therefore the same amount of disease that can be “induced” into drug resistance). Our data clearly show that relapse rates are different in these two patient populations.

Closer evaluation of the reports by Chopra et al. and Bierman et al. suggests other explanations. In the series reported by Chopra et al.,<sup>10</sup> multivariate analysis showed that disease bulk was the most important risk factor for disease progression at 5 years: only 13% of patients with disease >10 cm and 51% of those with disease measuring 5–10 cm were progression free. Therefore, the majority of the untested patients were likely to be in the more favorable group, with <5 cm disease at the time of autoSCT. Second, 120 of 155 patients had failed at least 2 lines of chemotherapy; hence, few of the untested patients would have received no therapy for first relapse and before autoSCT. Third, this cohort is unique in that it reports a significantly better outcome for patients in third or greater relapse (5-year PFS, 70%) compared with those in second or first relapse (5-year PFS, 60% and 47%, respectively), a finding opposite that of many other case series.<sup>9,12,22,23</sup> The authors made the observation that the length of first CR was longest for those in third relapse and shortest for those in first relapse, indicating that a large number of these patients likely had a relatively indolent disease course.<sup>10</sup> Of the 10 patients treated in untested relapse, in the small series reported from Nebraska,<sup>14</sup> 6 had “minimal” adenopathy and 1 had involvement of bone marrow only at the time of referral for transplant. A comparison of the extent of disease present at transplant in these patients with those who received salvage chemotherapy first was not made but would be helpful in clarifying the effect of disease bulk on this favorable outcome.

There are no randomized trials testing whether the use of salvage chemotherapy improves PFS or OS in patients with relapsed or refractory Hodgkin's disease. The extent of disease present at the time of autoSCT—whether a reflection of the

debulking effect of salvage chemoradiotherapy or the inherent biology of the disease itself—is clearly the most important determinant of outcome after high-dose therapy. The use of salvage chemotherapy before transplant is the only means available at present to uncover valuable information with respect to the potential value of autoSCT and the expectation of cure, but this information comes at a significant price. In the Toronto General Hospital series described above, the long-term risk of secondary myeloid malignancies in long-term survivors of autoSCT for relapsed or refractory Hodgkin's disease is 11% at 10 years. Data are emerging which suggest that patients who go on to develop this complication have clonal changes present in the bone marrow—and in the stem cells used to reconstitute hematopoiesis—at the time of high-dose therapy.<sup>25</sup> Analysis of more than 4500 patients with Hodgkin's disease in the BNLI database showed that the risk of developing MDS/AML was associated with the amount of prior chemotherapy and previous exposure to MOPP or lomustine.<sup>26</sup> After adjustment for these factors in a multivariate model, the relative risk of MDS/AML associated with BEAM and autoSCT was 1.83 (95% CI, 0.66–5.11;  $P=.25$ ). In addition, patients who are exposed to extensive prior therapy, especially alkylating agents such as BCNU, are more difficult to mobilize, and approximately one third will require a second stem cell collection before going on to high-dose therapy [M.C., unpublished data].

Salvage chemotherapy for Hodgkin's disease before autoSCT is therefore a necessary evil. Patients who respond to second-line therapy, particularly those with a complete response, do very well after autoSCT but remind us that more effective and less myelotoxic salvage therapy approaches need to be explored in this patient subgroup. Our treatments need to be refined for those with only a partial response or those who fail to respond to salvage chemotherapy. In this patient population, innovative approaches are required to reduce the relapse rate after autoSCT.

## REFERENCES

1. André M, Henry-Amar M, Pico J-L, et al. Comparison of high-dose therapy and autologous stem-cell transplantation with conventional therapy for Hodgkin's disease induction failure: a case-control study. *J Clin Oncol* 17:222–229, 1999.
2. Sweetenham JW, Carella AM, Taghipour G, et al. High-dose therapy and autologous stem cell transplantation for adult patients with Hodgkin's disease who do not enter remission after induction chemotherapy: results in 175 patients reported to the European Group for Blood and Marrow Transplantation. *J Clin Oncol* 17:3101–3109, 1999.
3. Lazarus HM, Rowlings PA, Zhang MJ, et al. Autotransplants for Hodgkin's disease in patients never achieving remission: a report from the Autologous Blood and Marrow Transplant Registry. *J Clin Oncol* 17:534–545, 1999.
4. Josting A, Reiser M, Rueffer U, et al. Treatment of primary progressive Hodgkin's and aggressive non-Hodgkin's lymphoma: is there a chance for cure? *J Clin Oncol* 18: 332–339, 2000.

5. Horning SJ, Chao NJ, Negrin RS, et al. High-dose therapy and autologous hematopoietic progenitor cell transplantation for recurrent or refractory Hodgkin's disease: analysis of the Stanford University results and prognostic indices. *Blood* 89:801-813, 1997.
6. Linch DC, Winfield D, Goldstone AH, et al. Dose intensification with autologous bone-marrow transplantation in relapsed and resistant Hodgkin's disease: results of a BNLI randomized trial. *Lancet* 341:1051-1054, 1993.
7. Schmidt N, Sextro M, Pfistner B, et al. High-dose therapy (HDT) followed by hematopoietic stem cell transplantation for relapsed chemosensitive Hodgkin's disease (HD): final results of a randomized GHSG and EBMT trial (HD-R1) [abstract]. *Proc Am Soc Clin Oncol* 18:2a, 1999. Abstract 5.
8. Crump M, Smith AM, Brandwein J, et al. High-dose etoposide and melphalan, and autologous bone marrow transplantation for patients with advanced Hodgkin's disease: importance of disease status at transplant. *J Clin Oncol* 11:704-711, 1993.
9. Armitage JO, Bierman PJ, Vose JM, et al. Autologous bone marrow transplantation for patients with relapsed Hodgkin's disease. *Am J Med* 91:605-611, 1991.
10. Chopra R, McMillan AK, Linch DC, et al. The place of high-dose BEAM therapy and autologous bone marrow transplantation in poor-risk Hodgkin's disease: a single-center eight-year study of 155 patients. *Blood* 81:1137-1145, 1993.
11. Yahalom J, Gulati SC, Toia M, et al. Accelerated hyperfractionated total-lymphoid irradiation, high-dose chemotherapy, and autologous bone marrow transplantation for refractory and relapsing patients with Hodgkin's disease. *J Clin Oncol* 11:1061-1070, 1993.
12. Reece DE, Barnett MJ, Connors JM, et al. Intensive chemotherapy with cyclophosphamide, carmustine, and etoposide followed by autologous bone marrow transplantation for relapsed Hodgkin's disease. *J Clin Oncol* 9:1871-1879, 1991.
13. O'Brien ME, Milan S, Cunningham D, et al. High-dose chemotherapy and autologous bone marrow transplant in relapsed Hodgkin's disease: a pragmatic prognostic index. *Br J Cancer* 73:1272-1277, 1996.
14. Bierman PJ, Anderson JR, Freeman MB, et al. High-dose chemotherapy followed by autologous hematopoietic rescue for Hodgkin's disease patients following first relapse after chemotherapy. *Ann Oncol* 7:151-156, 1996.
15. Wheeler C, Eickhoff C, Elias A, et al. High-dose cyclophosphamide, carmustine and etoposide with autologous transplantation in Hodgkin's disease: a prognostic model for treatment outcomes. *Biol Blood Marrow Transplant* 3:98-106, 1997.
16. Arranz R, Tomas JF, Gil-Fernandez JJ, et al. Autologous stem cell transplantation (ASCT) for poor prognostic Hodgkin's disease (HD): comparative results with two CBV regimens and importance of disease status at transplant. *Bone Marrow Transplant* 21:779-786, 1998.
17. Darrington DL, Vose JM, Anderson JR, et al. Incidence and characterization of secondary myelodysplastic syndrome and acute myelogenous leukemia following high-dose chemoradiotherapy and autologous stem-cell transplantation for lymphoid malignancies. *J Clin Oncol* 12:2527-2534, 1994.
18. Traweek ST, Slovak ML, Nademanee AP, et al. Clonal karyotypic hematopoietic cell abnormalities occurring after autologous bone marrow transplantation for Hodgkin's disease and non-Hodgkin's lymphoma. *Blood* 84:957-963, 1994.

19. Colwell R, Crump M, Couture F, et al. Mini-BEAM as salvage therapy for relapsed or refractory Hodgkin's disease before intensive therapy and autologous bone marrow transplantation. *J Clin Oncol* 13:396–402, 1995.
20. Velasquez WS, Cabanillas F, Salvador P, et al. Effective salvage therapy for lymphoma with cisplatin in combination with high-dose Ara-C and dexamethasone [DHAP]. *Blood* 71:117–122, 1988.
21. Tsang RW, Gospodarowicz MK, Sutcliffe SB, Crump M, Keating A. Thoracic radiation therapy before autologous bone marrow transplantation in relapsed or refractory Hodgkin's disease. *Eur J Cancer* 35:73–78, 1999.
22. Brice P, Bouabdallah R, Moreau P, et al. Prognostic factors for survival after high-dose therapy and autologous stem cell transplantation for patients with relapsing Hodgkin's disease: analysis of 280 patients from the French registry. *Bone Marrow Transplant* 20: 21–26, 1997.
23. Jagannath S, Armitage JO, Dicke KA, et al. Prognostic factors for response and survival after high-dose cyclophosphamide, carmustine, and etoposide with autologous bone marrow transplantation for relapsed Hodgkin's disease. *J Clin Oncol* 7:179–185, 1989.
24. Sweetenham JW, Taghipour G, Milligan D, et al. High-dose therapy and autologous stem cell rescue for patients with Hodgkin's disease in first relapse after chemotherapy: results from the EBMT. *Bone Marrow Transplant* 20:745–752, 1997.
25. Mach-Pascual S, Legare RD, Lu D, et al. Predictive value of clonality assays in patients with non-Hodgkin's lymphoma undergoing autologous bone marrow transplant: a single institution study. *Blood* 91:4496–4503, 1998.
26. Harrison CH, Gregory W, Vaughan Hudson G, et al. High-dose BEAM chemotherapy with autologous hematopoietic stem cell support is unlikely to be associated with a major increased risk of secondary MDS/AML. *Br J Cancer* 81:476–483, 1999.

# Pretransplant Salvage Therapy for Hodgkin's Disease: Additional Toxicity With No Survival Benefit

*John W. Sweetenham*

*Division of Medical Oncology, University of Colorado  
Health Sciences Center, Denver, Colorado*

## ABSTRACT

High-dose therapy (HDT) and autologous stem cell transplantation (autoSCT) produce long-term disease-free survival in 30%–50% of patients with relapsed or refractory Hodgkin's disease and have been shown to be superior to conventional-dose salvage therapy. Although studies of prognostic factors for these patients have produced conflicting results, most series have identified disease status and disease bulk at the time of autoSCT as predictive factors for disease-free and overall survival (OS), providing the rationale for cytoreductive therapy before HDT and autoSCT. However, the value of pretransplant cytoreductive chemotherapy has not been assessed prospectively and remains uncertain. In a European Group for Blood and Marrow Transplantation (EBMT) study of 139 patients with Hodgkin's disease receiving HDT and autoSCT in first relapse after chemotherapy, disease bulk at autoSCT did not predict for progression-free survival (PFS) or OS, and outcome for patients treated in untested relapse, without pretransplant cytoreductive therapy, was the same as those who received second-line treatment. Similar results have been reported in studies from Nebraska and London, with patients receiving autoSCT in untested relapse having a superior outcome to those receiving second-line therapy. An EBMT study of 175 patients with Hodgkin's disease undergoing HDT and autoSCT after failure of induction therapy showed no survival advantage for the use of a second-line chemotherapy regimen. A similar study from the Autologous Blood and Marrow Transplant Registry (ABMTR) did not identify disease status as a predictive factor in Hodgkin's disease patients receiving autoSCT after induction failure. Studies reporting the use of Dexa-BEAM (dexamethasone, BCNU, etoposide, cytosine arabinoside, and melphalan) before HDT have yielded conflicting results.

Disease bulk and disease status at the time of autoSCT may be surrogate markers for the intrinsic responsiveness of Hodgkin's disease to therapy and, therefore, may not provide a basis for pretransplant cytoreductive therapy. Furthermore, this therapy has significant short-term and potential long-term toxicity.

Pretransplant salvage therapy for Hodgkin's disease is unproven. Prospective randomized clinical trials are required to clarify its role.

## INTRODUCTION

High-dose therapy and autoSCT have been tested extensively in the treatment of patients with relapsed and refractory Hodgkin's disease.<sup>1-12</sup> They are now widely accepted as standard therapy for patients who relapse after 2 combination chemotherapy regimens such as MOPP (mechlorethamine, vincristine, procarbazine, and prednisone) and ABVD (doxorubicin, bleomycin, vinblastine, and dacarbazine). With the increasing use of 7- or 8-drug regimens as first-line therapy, the use of high-dose therapy at first relapse is also generally regarded as standard, especially for patients whose initial remission duration is <1 year. To date, 2 randomized prospective trials have compared high-dose therapy and autoSCT with conventional-dose salvage therapy in patients with relapsed Hodgkin's disease.<sup>13,14</sup> Both have reported an improvement in time to treatment failure and relapse rate, although neither demonstrated an improvement in overall survival, possibly because patients whose disease progressed or relapsed after conventional-dose therapy were salvaged by subsequent high-dose therapy.

The use of high-dose therapy and autoSCT for patients who fail to enter remission after induction chemotherapy has also increased in recent years. No randomized trials have tested this approach compared with conventional-dose second- or third-line therapy, but 2 recent large retrospective series have reported long-term disease-free survival rates of between 30% and 40% in patients receiving high-dose therapy and autoSCT after induction failure.<sup>15,16</sup>

In most centers, patients undergoing high-dose therapy and autoSCT are initially treated with conventional-dose cytoreductive chemotherapy before receiving the high-dose regimen. This approach is based on observations initially made in patients with non-Hodgkin's lymphoma (NHL), in whom it was shown that the responsiveness of the disease to conventional-dose therapy given before high-dose therapy was highly predictive of response to autoSCT and subsequent survival.<sup>17</sup> This approach was further supported by studies of prognostic factors for patients with Hodgkin's disease treated with autoSCT, in which disease bulk at the time of autoSCT and response to the conventional-dose regimen given immediately before high-dose therapy and autoSCT were shown to be important predictive factors for subsequent long-term survival.

However, studies of prognostic factors in this patient group have yielded conflicting results. Bulk of disease at the time of autoSCT and response to previous chemotherapy have not been consistently identified as predictive factors.

It is uncertain whether the apparent benefit of cytoreductive chemotherapy is a real phenomenon, or whether the observation of improved outcome in

optimally debulked patients is simply a surrogate for the intrinsic responsiveness of the disease.

Results of several published studies challenge the almost routine practice of cytoreduction before high-dose therapy and illustrate the need for a prospective randomized trial to test this approach.

### EBMT Studies

The issue of pretransplant cytoreductive therapy has been addressed in 2 retrospective studies from the EBMT.

**Patients in First Relapse After Chemotherapy.** This study included 139 patients who underwent high-dose therapy and autoSCT in first relapse after chemotherapy.<sup>18</sup> Patients in this study, who had achieved a complete remission (CR) or uncertain CR to initial combination chemotherapy, underwent high-dose therapy between February 1984 and July 1995. Most patients (82%) received MOPP, ABVD, MOPP alternating with ABVD, or variants of these regimens. Thirteen percent of patients received either hybrid regimens such as MOPP/ABV (mechlorethamine, vincristine, procarbazine, prednisone, doxorubicin, bleomycin, and vinblastine), or alternating weekly regimens including VAPEC-B (vinblastine, doxorubicin, prednisone, etoposide, cyclophosphamide, and bleomycin) and PACE-BOM (prednisone, doxorubicin, cyclophosphamide, etoposide, bleomycin, vincristine, and methotrexate). The median duration of first remission was 11.5 months (range, 6 months to 16.5 years). Details of second-line pretransplant therapy for this group are shown in Table 1.

**Table 1.** Second-Line (Cytoreductive) Therapy for Patients Undergoing High-Dose Therapy and Autologous Stem Cell Transplantation in First Relapse After Chemotherapy\*

<i>Regimen</i>	<i>n</i>	<i>%</i>
None (untested)	22	16
MOPP or variant	17	12
ABVD or variant	15	11
MOPP/ABVD or variant	14	10
DHAP	9	7
CEP	1	1
Mini-BEAM	11	8
Other	50	36

\*Adapted from Sweetenham et al.<sup>18</sup> ABVD, doxorubicin, bleomycin, vinblastine, and dacarbazine; CEP, lomustine, etoposide, and prednisone; DHAP, dexamethasone, cytosine arabinoside, and cisplatin; mini-BEAM, carmustine, etoposide, cytosine arabinoside, and melphalan; MOPP, mechlorethamine, vincristine, procarbazine, and prednisone.

**Table 2.** Disease Status at Time of High-Dose Therapy and Autologous Stem Cell Transplantation\*

<i>Status</i>	<i>n</i>	<i>%</i>
Second clinical remission	57	41
Sensitive relapse†	54	39
Resistant relapse†	6	4
Untested relapse†	22	16

\*Adapted from Sweetenham et al.<sup>18</sup> †Defined according to the criteria described by Philip et al.<sup>17</sup>

Sixteen percent of patients underwent autoSCT without prior cytoreductive therapy. The remainder were treated with various second-line regimens, depending on the active protocols at each center and the nature of the prior therapy. In general, the second-line regimen was chosen to be non-cross-resistant with the first-line regimen. The duration of therapy varied. In some centers, patients were treated with second-line therapy until they had achieved a complete remission. In other centers, second-line therapy was used for cytoreduction or to assess disease sensitivity, but patients were not required to achieve a CR before proceeding to autoSCT. Analysis of the presenting characteristics for patients who proceeded to autoSCT in untested relapse did not differ significantly from those who received second-line therapy. Disease status at the time of autoSCT is summarized in Table 2. Disease bulk at the time of high-dose therapy and autoSCT is summarized in Table 3.

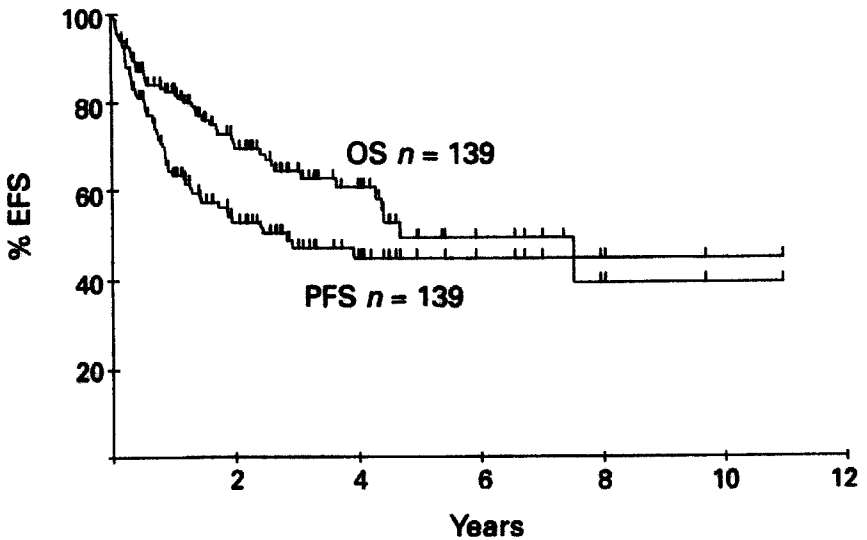
Factors predictive for outcome after autoSCT were determined using univariate (log-rank) and multivariate (Cox proportional hazards model) analysis. Factors examined in univariate and multivariate analysis were sex, stage at diagnosis, disease bulk at diagnosis, duration of first remission, second-line chemotherapy regimen, high-dose regimen, disease bulk at autoSCT, and source of stem cells. In view of the difficulty in determining remission status in Hodgkin's disease,

**Table 3.** Disease Bulk at Time of High-Dose Therapy and Autologous Stem Cell Transplantation\*

<i>Bulk</i>	<i>n</i>	<i>%</i>
Complete remission	57	41
<5 cm	55	40
5–10 cm	17	12
>10 cm	7	5
Unknown	3	2

\*Adapted from Sweetenham et al.<sup>18</sup>



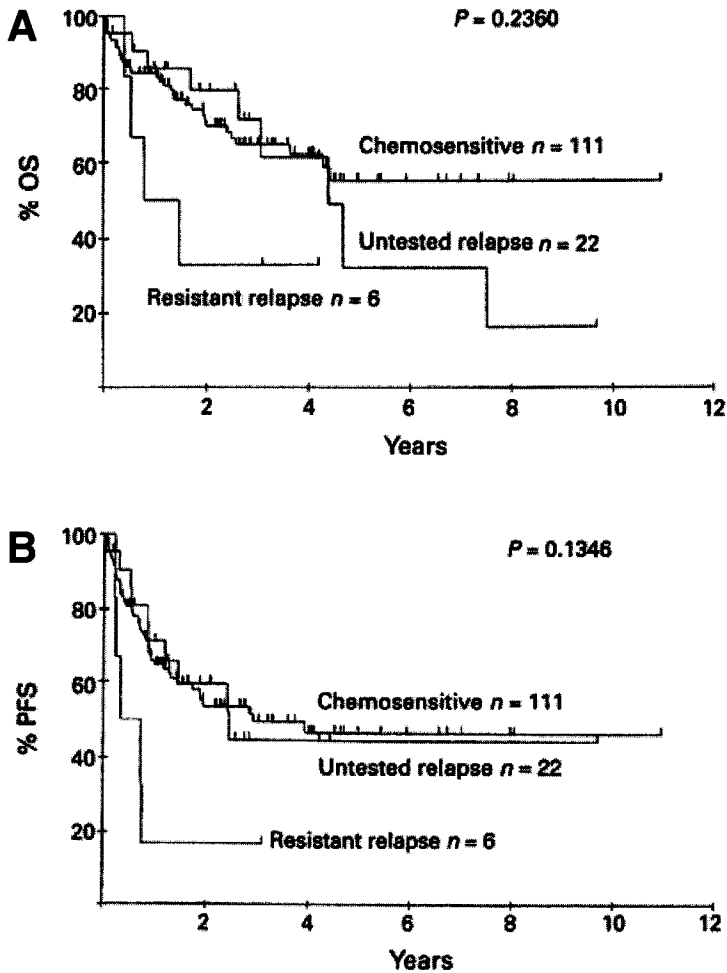


**Figure 1.** Overall and progression-free survival (OS and PFS) for 139 patients undergoing high dose therapy and autologous stem cell transplantation for Hodgkin's disease in first relapse after chemotherapy. EFS, event-free survival.

especially for patients who have residual mediastinal masses, the prognostic significance of disease status at autoSCT was assessed in 2 ways. Patients in sensitive relapse and second CR were analyzed both separately and as a single group.

## RESULTS

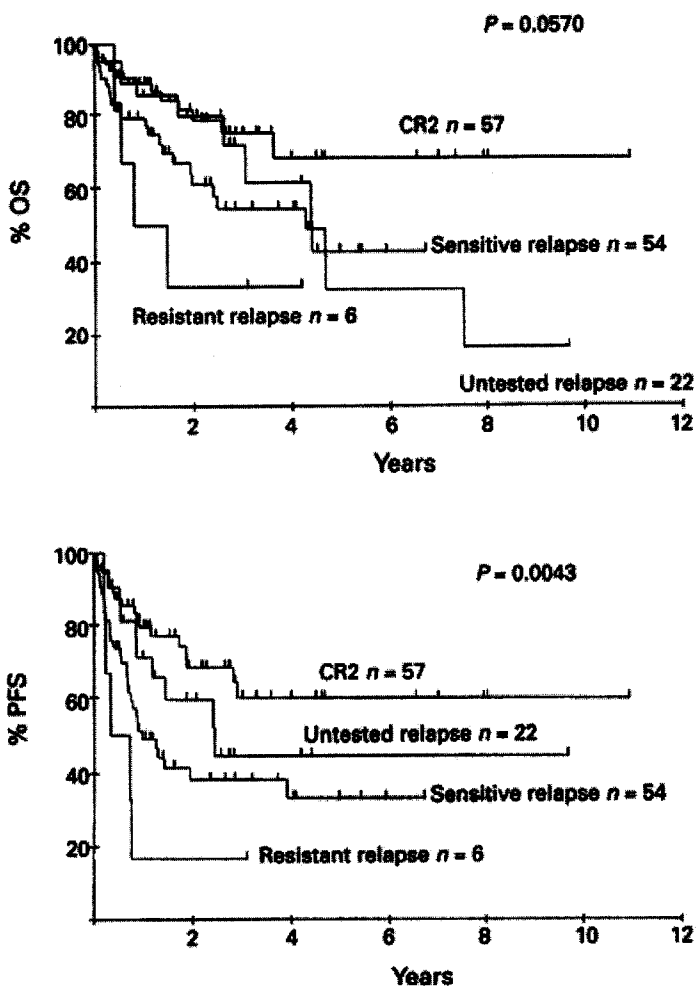
With a median follow-up of 2.75 years, the 5-year actuarial OS and PFS rates for all patients were 49% and 45%, respectively (Figure 1). None of the factors examined in univariate analysis was found to be predictive for either OS or PFS when patients in second CR and responsive relapse were analyzed together (Figure 2). A trend for poorer OS and PFS was observed for patients with resistant relapse. This trend was not significant, but the number of patients undergoing autoSCT in resistant relapse was very small ( $n = 6$ ). When the same analysis was performed separately for patients in second CR and responding relapse (Figure 3), the difference in PFS became significant, and that for OS was borderline ( $P = .057$ ). According to disease bulk, there was a trend for poorer OS in patients with  $<5$  cm disease at autoSCT compared with other groups. This achieved statistical significance for PFS. The reason for this is unclear. We investigated the possibility that patients with chemoresistant disease might be overrepresented in this group, but this was not the case (Figure 4). The OS and PFS for patients in untested relapse



**Figure 2.** A, Overall survival (OS) for patients undergoing autologous stem cell transplantation (autoSCT) in first relapse after chemotherapy according to disease status at autoSCT. B, Progression-free survival (PFS).

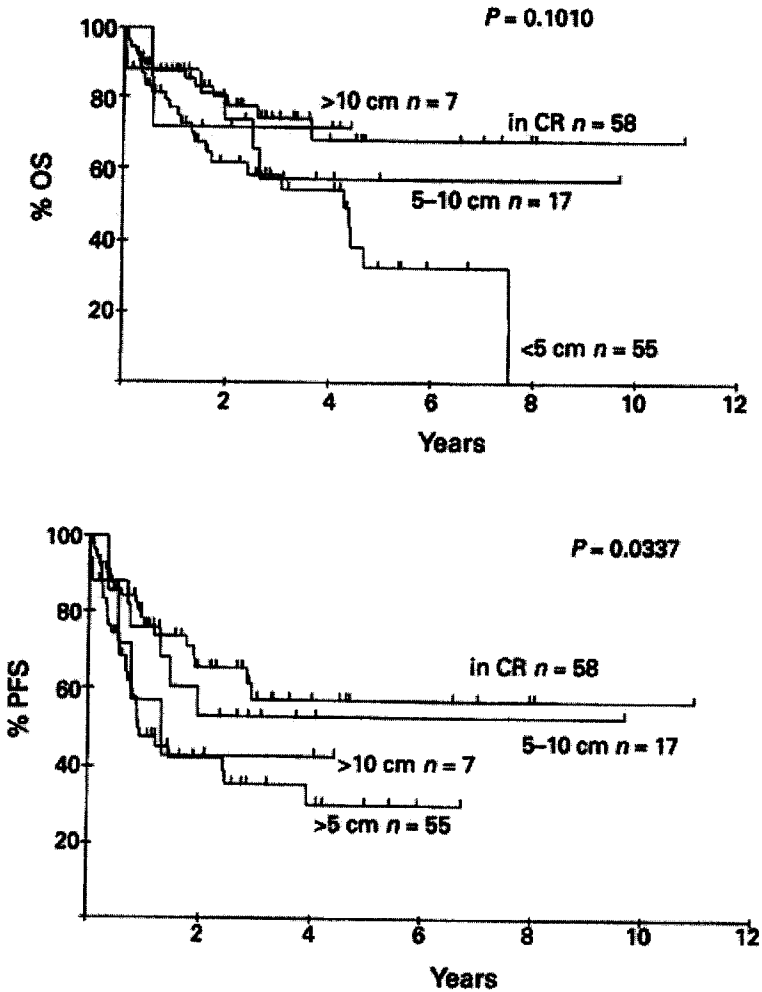
who had not received prior cytoreductive therapy did not differ significantly from those for whom such treatment had been given.

**Patients Who Failed to Enter Remission After Induction Therapy.** In a separate study, we analyzed outcome and prognostic factors for 175 patients with Hodgkin's disease who underwent high-dose therapy and autoSCT for Hodgkin's disease and had failed to enter remission after first-line or first- and second-line chemotherapy.<sup>16</sup> Between November 1979 and October 1995, 281 adults who



**Figure 3.** A, Overall survival (OS) for patients undergoing autologous stem cell transplantation (autoSCT) in first relapse after chemotherapy according to disease status, with patients in second complete remission (CR) analyzed separately. B, Progression-free survival (PFS).

received high-dose therapy and autoSCT after failure of induction therapy were reported to the EBMT lymphoma registry. In view of the difficulties in assessing response in Hodgkin's disease, we initially identified all patients who failed to achieve a PR, CR, or uncertain CR after combination chemotherapy of 1 or 2 regimens. This definition therefore included patients with progressive disease and stable or minimally responsive disease after remission induction therapy. After seeking additional information concerning details of induction therapy and



**Figure 4.** A, Overall survival (OS) for patients undergoing autologous stem cell transplantation (autoSCT) in first relapse after chemotherapy according to disease bulk at time of autoSCT. B, Progression-free survival (PFS). CR, complete remission.

response, 175 patients were identified for whom complete data were available for subsequent analysis. Seventy-five of these patients proceeded to high-dose therapy and autoSCT after failing a single induction regimen. The remaining 100 patients failed to enter remission after first- and second-line therapy. Details of therapy are shown in Table 4.

Univariate (log-rank) and multivariate (Cox proportional hazards model) analyses were performed to determine predictive factors for OS and PFS. The factors examined were sex, Ann Arbor stage, age, disease bulk at diagnosis, disease

**Table 4.** First- and Second-Line Therapy for European Groups for Blood and Marrow Transplantation Patients Receiving High-Dose Therapy and Autologous Stem Cell Transplantation After Failure of Induction Therapy\*

<i>Regimen</i>	<i>n</i>	<i>%</i>
First line		
MOPP, ABVD, or variant	59	34
Alternating MOPP/ABVD or variant	93	53
MOPP/ABV hybrid or variant	10	6
Brief duration, weekly regimen	6	3
Other	7	4
Second line		
None	75	43
MOPP or variant	9	5
ABVD or variant	7	4
Alternating MOPP/ABVD or variant	2	1
DHAP	6	3
CEP	7	4
Mini-BEAM	21	12
Other	57	33

\*Adapted from Sweetenham et al.<sup>16</sup> ABV, doxorubicin, bleomycin, and vinblastine; ABVD, doxorubicin, bleomycin, vinblastine, and dacarbazine; CEP, lomustine, etoposide, and prednisone; DHAP, dexamethasone, cytosine arabinoside, and cisplatin; mini-BEAM, carmustine, etoposide, cytosine arabinoside, and melphalan; MOPP, mechlorethamine, vincristine, procarbazine, and prednisone.

bulk at autoSCT, high-dose regimen, source of stem cells, number of induction regimens, response to induction regimen given immediately before high-dose therapy, and time interval between diagnosis and high-dose therapy.

**Results.** With a median follow up of 73 months, the 5-year actuarial OS and PFS rates for the whole study population were 36% and 32%, respectively. Univariate analysis identified only 2 prognostic factors. Patients receiving only 1 previous chemotherapy regimen had superior OS and PFS compared with those who received 2 prior regimens. Patients with an interval between diagnosis and autoSCT of <550 days had a superior OS and a nonsignificant trend for superior PFS compared with those with a longer interval. The disease bulk at the time of autoSCT had no predictive value in this series. The superior PFS and OS in patients receiving only 1 prior regimen may reflect the fact that this is a selected group that was proven to be refractory to only 1, rather than 2, chemotherapy regimens. Although there is no evidence from this study that the use of a second-line regimen contributed to long-term outcome, patients whose disease responded to second-line therapy were excluded from this analysis.

## Other Studies

Several other registry and single-institution retrospective studies have investigated prognostic factors for patients with Hodgkin's disease receiving high-dose therapy and autoSCT in various clinical situations. Results of these studies have been conflicting, possibly because of the relatively small patient numbers in most series.

In terms of assessing the role of cytoreductive chemotherapy, 2 prognostic factors are most likely to be informative, namely, disease status at the time of autoSCT and disease bulk at the time of autoSCT. These 2 factors are likely to be correlated.

**Disease Status at AutoSCT.** In a series from Vancouver, British Columbia, Canada, Reece et al.<sup>8</sup> reported on 58 patients who underwent high-dose therapy and autoSCT at first relapse. Initial cytoreductive therapy was used in all patients, most frequently using MVPP (mechlorethamine, vinblastine, procarbazine, and prednisone), but all patients proceeded to high-dose therapy, irrespective of their response. This therapy, therefore, was not used to select patients with chemosensitive disease, and no formal assessment of response was performed after cytoreductive therapy. The actuarial overall survival for all patients was 72%, with a median follow-up of 2.3 years. Although direct comparison with other series is difficult because of variable selection criteria for inclusion in transplant programs, these results are comparable with or superior to many series that have excluded patients in resistant relapse.

A series from City of Hope National Medical Center, Duarte, CA, also failed to identify disease status at autoSCT as a predictive factor in 85 patients with relapsed and refractory Hodgkin's disease.<sup>1</sup>

In contrast, several other studies have identified disease status as a predictive factor for OS and/or PFS. Crump et al.<sup>19</sup> reported a series of 73 patients receiving high-dose etoposide and melphalan with autoSCT, in whom disease status at autoSCT was the most important predictive factor for disease-free survival (DFS). This study defined disease status on the basis of disease bulk rather than responsiveness to cytoreductive chemotherapy. Actuarial 4-year DFS was 68% for patients with no evidence of disease at autoSCT, 26% for those with nonbulky residual disease, and 0% for those with bulky residual disease.

A study from Koln, Germany, reported a series of 26 patients with relapsed or refractory Hodgkin's disease who were treated with 2–4 cycles of Dexa-BEAM followed by high-dose therapy and autoSCT in those patients who achieved a CR or PR to DexaBEAM.<sup>11</sup> Eighteen of the 26 patients (69%) responded to DexaBEAM and proceeded to autoSCT. The 3-year actuarial PFS was 55% for all 26 patients. The authors concluded that the result justified their approach of cytoreductive therapy to maximum response before high-dose therapy and autoSCT. However, results in this small series are comparable to series in which less stringent selection criteria for

autoSCT were used, and because chemoresistant patients were not offered autoSCT, it is not possible to determine the impact of cytoreductive therapy on PFS or OS.

Studies from London<sup>3</sup> and Nebraska<sup>5</sup> have identified disease status as a predictive factor. In both studies, superior PFS was observed in patients treated with high-dose therapy in untreated relapse, compared with those in chemosensitive or chemoresistant relapse. The reason for this difference is unclear, although it may represent selection bias, in that patients selected for autoSCT in untreated relapse may be more likely to have only minimal disease at the time of relapse or progression, such that cytoreductive therapy is not considered worthwhile.

**Disease Bulk at AutoSCT.** The presence of large-volume disease at autoSCT has been identified as an adverse factor in several previous studies. Rapaport et al.<sup>20</sup> reported the experiences of 100 patients with lymphoma, 47 of whom had Hodgkin's disease, who received high-dose therapy and autoSCT for relapsed or refractory disease. Patients were initially treated with cytoreductive therapy, using DHAP (dexamethasone, cytosine arabinoside, and cisplatin), MOPP, ABVD, a hybrid, or in a few patients, other regimens. In addition, 10 patients underwent either radiation therapy or surgical debulking before SCT.

Patients receiving chemotherapy were treated until CR or best response, although it is not clear whether patients who did not respond to cytoreductive therapy were excluded from subsequent autoSCT. The definition of bulk disease in this study was any mass measuring  $\geq 2$  cm. Disease bulk was the most powerful predictive factor for event-free survival (EFS) in this study, with a 3-year actuarial EFS of 70% for patients without bulky disease, compared with 15% for those with disease  $\geq 2$  cm. Similar results were reported in the study from Ontario (see above) and also in studies from London and Nebraska.

Among prognostic factors identified at Stanford University Medical Center, disease bulk at autoSCT was an independent prognostic factor on multivariate analysis.<sup>7</sup> Most patients received conventional-dose cytoreductive therapy initially in an attempt to achieve a minimal residual disease state. This was defined as a  $>75\%$  reduction in a bulky ( $\geq 10$  cm) mass or no individual mass  $>2$  cm in diameter. Various regimens were used for cytoreduction, depending on the previous therapy in each patient. The authors commented that patients who failed to respond to their first cytoreductive regimen were changed to an alternative regimen, although it is not clear whether any subsequent selection took place on the basis of response to this treatment. In this study, status before transplant was a powerful predictive factor for freedom from progression (FFP), OS, and EFS, with those patients with minimal disease having a significantly superior outcome.

In contrast, the recent study from the Autologous Blood and Marrow Transplant Registry (ABMTR), which included patients who never achieved remission after induction therapy, did not identify disease bulk as a predictive factor, although the

authors acknowledged that most patients had bulky (mostly mediastinal) disease prior to autoSCT.<sup>15</sup>

The results of all the studies mentioned above show clearly that disease status and disease bulk at the time of autoSCT are closely related, and one or both of these have been identified as prognostic factors for patients receiving autoSCT for Hodgkin's disease in many series. Although certain studies have demonstrated that patients treated in untested relapse have a particularly favorable outcome, this group is likely to be highly selected, representing a group with only minimal disease at the time of relapse, in whom cytoreductive therapy is not considered necessary.

Despite these observations, the contribution of pretransplant cytoreductive therapy to long-term survival remains unclear. Because all of these studies are retrospective in nature, and because none has apparently developed a consistent policy of inclusion or exclusion of patients with chemoresistant disease, it is possible that the status at transplant and disease bulk at the time of autoSCT are simply surrogates for the intrinsic responsiveness of the disease.

One small study has attempted to investigate the impact of Dexa-BEAM given before BEAM and autoSCT on overall survival after transplantation.<sup>21</sup> This was a retrospective comparison that included 61 patients with relapsed or refractory Hodgkin's disease, 18 of whom did not receive cytoreductive therapy before high-dose therapy and autoSCT. The other patients all received cytoreductive chemotherapy using 1 or 2 cycles of DexaBEAM. With a median survival of 48 months, there was no difference in OS between the 2 groups (66% for those receiving Dexa-BEAM vs. 71% for those with no Dexa-BEAM;  $P=.3$ ). Unfortunately, the report of this study does not indicate how patients were selected for cytoreductive therapy or whether patients who did not respond to this therapy still proceeded to high-dose therapy and autoSCT.

Prospective studies are required to determine the true effect of cytoreductive therapy on long-term outcome. To date, very few prospective studies have addressed this issue. The German Hodgkin's Disease Study Group (GHSG) and EBMT have reported a prospective, randomized trial comparing conventional-dose with high-dose salvage therapy for patients with relapsed Hodgkin's disease.<sup>14</sup> However, patients who failed to respond to initial cytoreductive chemotherapy with DexaBEAM were excluded from randomization in this study.

### Cytoreductive Regimens

In addition to the uncertainty with respect to the impact of cytoreductive therapy on outcome, there is no consensus about the optimal regimen. Some centers have reported the use of debulking radiation therapy to large masses, particularly mediastinal masses, before high-dose therapy. However, this approach is associated with a high rate of subsequent pulmonary toxicity and treatment-related mortality and should not be used.<sup>7,22</sup>



Very few centers have adopted a consistent policy with respect to the choice of cytoreductive chemotherapy regimen. The choice of regimen has been based mostly on the desire to use a regimen non-cross-resistant with that used as initial therapy. As a result of this policy, the potential toxicity of cytoreductive therapy has been difficult to determine, because it is not included in most reports. Similarly, there are no comparative data on the efficacy of different cytoreductive regimens.

Some centers and collaborative groups have used either mini-BEAM or DEXA-BEAM consistently as cytoreductive regimens. Some data therefore exist on the short-term toxicity of these regimens. Myelosuppression has been the predominant reported toxicity. In the GHSG randomized study, of 139 patients treated with DEXA-BEAM, 9 (6.5%) suffered toxic deaths, and a further 5 (3%) did not proceed to autoSCT because of reported life-threatening toxicity.<sup>14</sup> A single toxic death was reported in the series from Koln, in which 26 patients received DEXA-BEAM cytoreduction before autoSCT.<sup>11</sup>

In contrast, the reported toxicity of mini-BEAM in this context has been less. Both the British National Lymphoma Investigation (BNLI) study<sup>13</sup> and a study from Toronto<sup>23</sup> reported severe myelosuppression, but no toxic deaths were reported with this regimen.

It is unclear whether the use of cytoreductive chemotherapy may also contribute to long-term toxicity following autoSCT. In a recent study, the risk of secondary myelodysplastic syndrome (MDS) and acute myeloid leukemia (AML) following autoSCT for Hodgkin's disease was shown to be attributable to the chemotherapy given before the high-dose regimen, rather than to the high-dose procedure itself.<sup>24</sup> Specifically, exposure to MOPP-type chemotherapy and nitrosoureas was identified as a risk factor for secondary MDS/AML. This provides further rationale for avoidance of cytoreductive therapy unless its role is proven.

## SUMMARY

The use of cytoreductive therapy before high-dose therapy and autoSCT for Hodgkin's disease is unproven and is associated with significant toxicity. Identification of prognostic factors in these patients has been inconsistent in published studies, although most identify either low disease bulk at the time of autoSCT and/or chemosensitive disease at the time of autoSCT as favorable prognostic factors. Response to cytoreductive chemotherapy may be a surrogate for sensitivity of the disease to high-dose therapy. Its benefit may be to select patients more likely to respond to high-dose therapy and to allow time for planning of autoSCT in busy transplant schedules. Its contribution to long-term outcome after autoSCT is not clear.

## ACKNOWLEDGMENTS

The author acknowledges the Lymphoma Working Party of the EBMT and all EBMT centers who contributed patients to the studies included in this article. In addition, the contributions of Prof. Angelo M. Carella (Ospedale S. Martino, Genova, Italy), G. Taghipour (EBMT Lymphoma Registry, London, UK), Prof. Norbert Schmitz (Christian Albrechts University, Kiel, Germany), and Prof. Anthony H. Goldstone (University College Hospital, London, UK) are acknowledged.

## REFERENCES

1. Nademanee A, O'Donnel MR, Snyder DS, et al. High dose chemotherapy with or without total body irradiation followed by autologous bone marrow and/or peripheral blood stem cell transplantation for patients with relapsed and refractory Hodgkin's disease: results in 85 patients with analysis of prognostic factors. *Blood* 85:1381-1390, 1995.
2. Yahalom J, Gulati SC, Toia M, et al. Accelerated hyperfractionated total-lymphoid irradiation, high dose chemotherapy, and autologous bone marrow transplantation for refractory and relapsing patients with Hodgkin's disease. *J Clin Oncol* 11:1062-1070, 1993.
3. Chopra R, MacMillan AK, Linch DC, et al. The place of high-dose BEAM therapy and autologous bone marrow transplantation in poor risk Hodgkin's disease: a single center eight year study of 155 patients. *Blood* 81:1137-1145, 1993.
4. Gianni AM, Sienna S, Bregni M, et al. Prolonged disease free survival after high-dose sequential chemo-radiotherapy and haemopoietic autologous transplantation in poor prognosis Hodgkin's disease. *Ann Oncol* 2:645-653, 1991.
5. Bierman PJ, Bagin RG, Jagannath S, et al. High dose chemotherapy followed by autologous hematopoietic rescue in Hodgkin's disease: long term follow up in 128 patients. *Ann Oncol* 4:767-773, 1993.
6. Yuen AR, Rosenberg SA, Hoppe RT, et al. Comparison between conventional salvage therapy and high-dose therapy with autografting for recurrent or refractory Hodgkin's disease. *Blood* 89:814-822, 1997.
7. Horning SJ, Chao NJ, Negrin RS, et al. High-dose therapy and autologous hematopoietic progenitor cell transplantation for recurrent or refractory Hodgkin's disease: analysis of the Stanford University results and prognostic indices. *Blood* 89:801-813, 1997.
8. Reece DE, Barnett MJ, Connors JM, et al. Intensive chemotherapy with cyclophosphamide, carmustine and etoposide followed by autologous bone marrow transplantation for relapsed Hodgkin's disease. *J Clin Oncol* 9:1871-1879, 1991.
9. Ribrag V, Nasr F, Bouhris JH, et al. VIP (etoposide, ifosfamide and cisplatinium) as a salvage intensification program in relapsed or refractory Hodgkin's disease. *Bone Marrow Transplant* 21:969-974, 1998.
10. Lancet JE, Rapoport AP, Brasacchio R, et al. Autotransplantation for relapsed or refractory Hodgkin's disease: long-term follow up and analysis of prognostic factors. *Bone Marrow Transplant* 22:265-271, 1998.
11. Josting A, Katay I, Rueffer U, et al. Favorable outcome of patients with relapsed or

- refractory Hodgkin's disease treated with high-dose chemotherapy and stem cell transplantation at the time of maximal response to conventional salvage therapy (Dexa BEAM). *Ann Oncol* 9:289–295, 1998.
12. Josting A, Reiser M, Rueffer U, et al. Treatment of primary progressive Hodgkin's and aggressive non-Hodgkin's lymphoma: is there a chance for cure? *J Clin Oncol* 18: 332–339, 2000.
  13. Linch DC, Winfield D, Goldstone AH, et al. Dose intensification with autologous bone marrow transplantation in relapsed and resistant Hodgkin's disease: results of a BNLI randomized trial. *Lancet* 341:1051–1054, 1993.
  14. Schmitz N, Sextro M, Pfistner D, et al. High-dose therapy (HDT) followed by hematopoietic stem cell transplantation (HSCT) for relapsed chemosensitive Hodgkin's disease (HD): final results of a randomized GHSG and EBMT trial [abstract]. *Proc ASCO* 18:2a, 1999.
  15. Lazarus HM, Rowlings PA, Zhang M-J, et al. Autotransplants for Hodgkin's disease in patients never achieving remission: a report from the Autologous Blood and Marrow Transplant Registry. *J Clin Oncol* 17:534–545, 1999.
  16. Sweetenham JW, Carella AM, Taghipour G, et al. High-dose therapy and autologous stem-cell transplantation for adult patients with Hodgkin's disease who do not enter remission after induction chemotherapy: results in 175 patients reported to the European Group for Blood and Marrow Transplantation. *J Clin Oncol* 17:3101–3109, 1999.
  17. Philip T, Armitage JO, Spitzer G, et al. High-dose therapy and autologous bone marrow transplantation after failure of conventional chemotherapy in adults with intermediate-grade or high-grade non-Hodgkin's lymphoma. *N Engl J Med* 316:1493–1498, 1987.
  18. Sweetenham JW, Taghipour G, Milligan D, et al. High-dose therapy and autologous stem cell rescue for patients with Hodgkin's disease in first relapse after chemotherapy: results from the EBMT. *Bone Marrow Transplant* 20:745–752, 1997.
  19. Crump M, Smith AM, Brandwein J, et al. High-dose etoposide and melphalan and autologous bone marrow transplantation for patients with advanced Hodgkin's disease: importance of disease status at transplant. *J Clin Oncol* 11:704–711, 1993.
  20. Rapoport AP, Rowe JM, Kouides PA, et al. One hundred autotransplants for relapsed or refractory Hodgkin's disease and lymphoma: value of pretransplant disease status for predicting outcome. *J Clin Oncol* 11:2351–2361, 1993.
  21. Uss A, Zmatschinski V, Milanovich NF, et al. Is it necessary to perform cytoreductive chemotherapy (DEXA-BEAM, DEXA-BEAC) before high-dose chemotherapy for poor prognosis Hodgkin's disease? *Ann Oncol* 10:S172, 1999.
  22. Tsang RW, Gospodarowicz MK, Sutcliffe SB, et al. Thoracic radiation therapy before autologous bone marrow transplantation in relapsed or refractory Hodgkin's disease. *Eur J Cancer* 35:73–78, 1999.
  23. Colwill R, Crump M, Couture F, et al. Mini-BEAM as salvage therapy for relapsed or refractory Hodgkin's disease before intensive therapy and autologous bone marrow transplantation. *J Clin Oncol* 13:396–402, 1995.
  24. Harrison CN, Gregory W, Vaughan-Hudson G, et al. High-dose BEAM chemotherapy with autologous haemopoietic stem cell transplantation for Hodgkin's disease is unlikely to be associated with a major increased risk of secondary MDS/AML. *Br J Cancer* 81: 476–483, 1999.

# **Allogeneic Stem Cell Transplantation in Patients With Hodgkin's Disease Who Relapse After Autologous Transplantation**

**César O. Freytes, Fausto R. Loberiza,  
Tsuong W. Tsai, Koen van Besien, Donna E. Reece,  
Gordon L. Phillips, Philip J. Bierman, David H. Vesole,  
Gustavo Milone, Santiago Pavlovsky, Julie M. Vose,  
Hillard M. Lazarus, Mary M. Horowitz**

*University of Texas Health Science Center at San Antonio (C.O.F., T.W.T.);  
University of Illinois (K.v.B.); University of Kentucky (D.E.R., G.L.P.); Medical  
College of Wisconsin (F.R.L., D.H.V., M.M.H.); University of Nebraska (P.J.B.,  
J.M.V.); FUNDALEU (G.M., S.P.), Buenos Aires, Argentina; Case Western  
Reserve (H.M.L.); the International Bone Marrow Transplant Registry and  
Autologous Bone Marrow Transplant Registry (F.R.L., M.M.H.)*

## **ABSTRACT**

Radiation therapy and conventional-dose chemotherapy can cure the majority of patients with Hodgkin's disease (HD). Nevertheless, patients who do not respond to induction chemotherapy or relapse after chemotherapy have a poor prognosis. High-dose chemotherapy with autologous hematopoietic stem cell transplantation (autoHSCT) can produce prolonged remissions in 40% to 70% of patients with HD who relapse after chemotherapy and 30% to 40% of patients with primary refractory disease. It is evident that despite the success of autoHSCT, a significant proportion of patients do not benefit from this therapy. Allogeneic HSCT (alloHSCT) has been used as treatment for relapsed HD. Advantages of allogeneic over autologous transplantation include a graft free of tumor and the graft-vs.-tumor effect. A review of the literature suggests that patients who undergo alloHSCT have a lower relapse rate posttransplantation but that this benefit is offset by higher transplant-related mortality. AlloHSCT has also been used in patients who relapse after autoHSCT. Published reports and registry data suggest that a small proportion of patients who relapse after autologous transplantation can attain prolonged remissions after an allogeneic transplant. Unfortunately, the treatment-related mortality of this approach is high, and most patients die early after allogeneic transplantation of infections, organ failure, and other complications. We

conclude that the high mortality observed in patients with HD who undergo alloHSCT after failing an autologous transplant and the small proportion of patients that benefit from this procedure should be taken into consideration when treatment is being considered for these patients. More effective therapies are needed to treat patients with HD who relapse after an autologous transplant.

## INTRODUCTION

The majority of patients with Hodgkin's disease are cured with radiotherapy or conventional chemotherapy. Nevertheless, patients who fail to respond to induction chemotherapy or who relapse after attaining a complete remission cannot be cured with standard chemotherapy and have a poor prognosis.<sup>1</sup> High-dose chemotherapy with autoHSCT can induce prolonged remissions in patients with primary refractory and relapsed HD.<sup>2</sup> Despite the success of autologous stem cell transplantation, a significant proportion of patients fail to benefit from this modality of therapy. Allogeneic stem cell transplantation has also been used in patients with primary refractory and relapsed HD. In this article, we discuss the proportion of patients who fail to benefit from autoHSCT for HD, the results obtained after alloHSCT for this disease, and the results reported after allografting patients who fail an autologous hematopoietic stem cell transplant for HD.

## MATERIALS AND METHODS

We performed a review of the English-language literature relevant to autologous and allogeneic transplantation for HD from 1985 to May 2000. Preliminary data from the International Bone Marrow Transplant Registry (IBMTR) and Autologous Blood and Marrow Transplant Registry (ABMTR) were analyzed.

## RESULTS

### Proportion of Patients With HD Who Do Not Benefit From Autologous Transplant

The length of the initial complete remission is an important prognostic factor of the ability to attain a second remission in patients with HD. In a long-term follow-up study from the National Cancer Institute, 85% of patients with initial remission duration of >1 year entered a second complete remission after the same induction chemotherapy or other salvage regimen compared with only 45% of patients who had an initial remission of <1 year.<sup>3</sup> Unfortunately, only 24% of patients with initial remissions of >1 year and 11% of patients with initial remissions of <1 year survived beyond 11 years.<sup>4</sup> Table 1 illustrates the results of several series using

**Table 1.** Progression-Free Survival of Patients With Relapsed Hodgkin's Disease Treated With Autologous Hematopoietic Stem Cell Transplantation

<i>Authors</i>	<i>Reference</i>	<i>Remission &lt;1 y, %</i>	<i>Remission ≥1 y, %</i>	<i>Median Follow-Up, y</i>
Chopra et al.	5	43	62	8.0
Reece et al.	6	48	85	2.3
Nademanee et al.	7	51	63	2.3
Yuen et al.	8	56	66	3.6
Horning et al.	9	40	75	4.3
Bierman et al.	10	32	47	2.4

autoHSCT as treatment for patients with HD who relapsed after an initial remission. As expected, patients who enjoyed initial remissions >1 year had a higher probability of attaining a second prolonged remission.<sup>4-10</sup> The progression-free survival of patients with initial remissions >1 year ranged from 47% to 62%, whereas progression-free survival of patients with initial remissions <1 year varied from 32% to 56%. The median follow-up of these studies ranged from 2.4 to 8 years.

Patients with HD who fail to respond to initial chemotherapy can also benefit from autoHSCT.<sup>5,11-15</sup> Table 2 illustrates the progression-free survival of patients with HD who failed to respond to initial chemotherapy observed in several investigations with at least 2 years of median follow-up. The probability of attaining a prolonged disease-free survival ranged from 27% to 42%. The median follow-up of these studies ranged from 2 to 8 years.

Despite the success of autoHSCT, these series demonstrate that a large proportion of patients who undergo autologous stem cell transplantation fail to benefit from this therapy. From 44% to 68% of patients with initial remission durations of <1 year failed to benefit from autologous transplantation. In the more favorable cohort of patients with initial remission durations of >1 year, 15% to 43% of patients failed to attain prolonged remissions after autologous stem cell

**Table 2.** Progression-Free Survival (PFS) of Patients With Primary Refractory Hodgkin's Disease Treated With Autologous Hematopoietic Stem Cell Transplantation

<i>Authors</i>	<i>Reference</i>	<i>No. of Patients</i>	<i>PFS</i>	<i>Median Follow-Up, y</i>
Phillips et al.	11	26	27	3.8
Gianni et al.	12	16	31	6.0
Chopra et al.	5	46	33	8.0
Reece et al.	13	30	42	3.6
Lazarus et al.	14	122	38	2.0
Sweetenham et al.	15	175	32	6.0

**Table 3.** Allogeneic Hematopoietic Stem Cell Transplantation for Hodgkin's Disease\*

<i>Authors</i>	<i>Reference</i>	<i>No. of Patients</i>	<i>EFS/FFP at 3 y, %</i>	<i>Nonrelapse Mortality, %</i>
Appelbaum et al.	16	8	25	50
Phillips et al.	17	8	13	50
Lundberg et al.	18	7	43†	29
Jones et al.	19	20	30	52
Anderson et al.	20	53	22‡	53
Gajewski et al.	21	100	15	61

\*EFS, event-free survival; FFP, freedom from progression; †at 1.5 y; ‡at 5 y.

transplantation. Patients with primary refractory HD have a lower probability of obtaining a durable remission. As many as 73% of patients who did not attain an initial complete remission will not benefit from autoSCT.

### AlloSCT in the Treatment of Hodgkin's Disease

AlloSCT has been used in the treatment of HD. Advantages of allogeneic over autologous transplantation include a graft free of tumor and the graft-vs.-tumor effect. Although the initial reports of this modality of therapy as treatment of HD included small number of patients, more recent studies have included larger numbers of patients and adequate follow-up.<sup>16-21</sup> Table 3 illustrates selected series of patients who have been treated with alloHSCT for HD. The event-free survival (EFS) of patients with HD who have undergone alloHSCT ranges from 13% to 43% at 3 years. The nonrelapse mortality of these series varied from 29% to 61%.

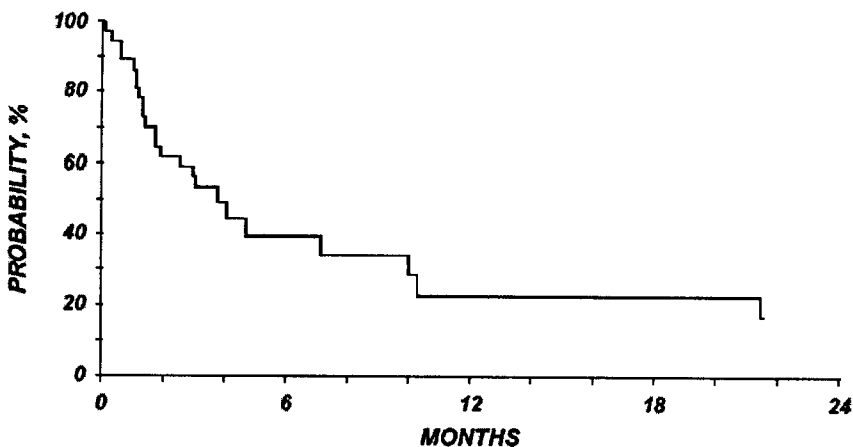
In two of these studies,<sup>19,20</sup> the results after alloHSCT were compared with the results after autoHSCT. Single-institution reports from Seattle and Johns Hopkins University using alloHSCT as treatment for relapsed or refractory HD suggest that the EFS of patients treated with alloHSCT is similar to the EFS of patients treated with autoHSCT. In the report from Seattle, the EFS did not differ statistically between alloHSCT and autoHSCT. The actuarial 5-year survival was 22% for alloHSCT vs. 13% for autoHSCT. In the report from Johns Hopkins University, the EFS of patients transplanted in sensitive relapse who received autologous transplantation was 51% compared with 56% in patients who received allogeneic transplants. Despite the fact that the relapse rate has been consistently lower after alloHSCT, the treatment-related mortality has also been higher in patients treated with alloHSCT, offsetting the benefit of the graft-vs.-tumor effect.

A report from the IBMTR analyzed the outcome of 100 consecutive patients with advanced HD who underwent HLA-identical sibling bone marrow transplan-

tation.<sup>21</sup> The 3-year overall survival was 21%, and the 3-year disease-free survival was 15% (Figure 1). The 3-year probability of relapse was 65%. The authors concluded that HLA-identical sibling bone marrow transplantation has a limited role in advanced HD.

The European Bone Marrow Transplant Registry (EBMTR) analyzed their results after alloHSCT as treatment of HD and compared it with the results obtained after autologous transplantation.<sup>22</sup> Forty-five patients who underwent allogeneic transplantation were matched to 45 patients who underwent autologous stem cell transplantation. The matching criteria included sex, age at time of transplantation, stage of disease at diagnosis, bone marrow involvement at diagnosis and transplantation, year of transplantation, disease status at time of transplantation, time from diagnosis to transplantation, and conditioning regimen with or without total body irradiation. The 4-year actuarial survival and progression-free survival rates were 25% and 15% in the allogeneic group compared with 37% and 24% in the autologous group. Although they observed a graft-vs.-tumor effect in patients with graft-vs.-host disease (GVHD) grade II or higher, its positive effect on relapse was offset by its toxicity. The authors of the study concluded that allogeneic bone marrow transplantation from an HLA-identical sibling donor did not offer any advantage compared with autologous bone marrow transplantation.

In summary, patients treated with alloHSCT for relapsed or refractory HD have a lower relapse rate posttransplantation, but this beneficial effect is offset by the higher treatment-associated mortality observed after alloHSCT.



**Figure 1.** Survival of patients who underwent allogeneic stem cell transplantation after autologous stem cell transplantation for Hodgkin's disease reported to the International Bone Marrow Transplant Registry.



## AlloHSCT in Patients With HD Who Relapse After Autologous Transplantation

Because a significant number of patients with HD relapse after autologous stem cell transplantation, second stem cell transplants have been used in this population of patients.

A report from the EBMTR described the results of second transplants in the management of lymphomas, including HD.<sup>23</sup> Twelve patients with HD underwent second HSCTs. Eight of the 12 patients had relapsed after autoHSCT, and 3 had obtained only a partial remission after autoHSCT. One patient received tandem transplants as treatment of relapse after conventional chemotherapy. Four of the 12 patients remained in complete remission, 21, 27, 31, and 54 months after the second transplant. Of those 4 patients, 3 had been transplanted for relapses after their initial autologous transplants. Of the 3 patients transplanted for a second time because they only obtained a partial response after the initial transplant, only 1 was alive and free of disease at the time of the report. Two of the patients in this report underwent alloHSCT after autoHSCT. Both patients died from progression of disease.

Vose et al.<sup>24</sup> reported on 4 patients who underwent second stem cell transplants for progression after autologous transplantation. Two patients received autoHSCT, 1 an HLA-identical sibling alloHSCT, and 1 a syngeneic transplant. Three of the 4 patients died of bacterial or fungal sepsis during the transplant. The fourth patient received a second autoHSCT with a subsequent relapse.

Table 4 illustrates the experience of Tsai et al.<sup>25</sup> with 10 patients who underwent alloHSCT after autoHSCT for HD at 5 institutions. The median age of this group was 32 years (range, 23–39 years). The median time from diagnosis to autologous transplantation was 24.5 months (range, 14–72 months). The median time from autologous to allogeneic transplantation was 19 months (range, 14–53 months). Of

**Table 4.** Allogeneic Hematopoietic Stem Cell Transplantation (AlloHSCT) in Patients With Hodgkin's Disease Who Relapsed After Autologous Transplantation\*

Patients, <i>n</i>	10
Median age, <i>y</i> (range)	35 (23–39)
Median time from diagnosis to autoHSCT, <i>mo</i> (range)	24.5 (14–72)
Median time from autoHSCT to alloHSCT, <i>mo</i> (range)	19 (14–53)
Conditioning regimen for alloHSCT	Bu/Cy†
Incidence of grade II–IV GVHD, %	90
Long-term survivors, %	10
Treatment-related mortality, %	90

\*AutoHSCT, autologous hematopoietic stem cell transplantation; Bu/Cy, busulfan/cyclophosphamide; GVHD, graft-vs.-host disease; †*n* = 7.

interest is the fact that 7 of the 10 patients received busulfan and cyclophosphamide as conditioning regimens. Eight of the 10 patients received alloHSCT from an HLA-identical sibling. One patient underwent a 1-antigen-mismatched related transplant and 1 a matched unrelated transplant. Only 1 patient was alive at the time of the report. Six of the patients died of infectious complications and 2 of veno-occlusive disease of the liver. All of the deaths in the report were treatment related. Although not listed as the direct cause of death, 90% of evaluable patients experienced grade II-IV GVHD. The authors concluded that because of the high treatment-related mortality observed after alloHSCT in patients who failed an autologous transplant, other treatments should be considered in this population of patients.

To date, 37 patients who underwent alloHSCT after an autoHSCT have been reported to the IBMTR (Table 5). The median age of the patients was 27 years (range, 17-38 years). Only 46% had a Karnofsky performance status of >90%. Twenty-six (70%) underwent HLA-identical sibling transplants, 6 (16%) underwent unrelated transplants, 4 underwent related haploidentical transplants, and 1 (3%) received an identical twin transplant. Eighty-one percent of patients received bone marrow as the source of stem cells.

Eighty-nine percent of patients who underwent alloHSCT after autoHSCT for HD attained neutrophil engraftment. In contrast to other studies, only 30% developed grade II-IV acute GVHD. Seventeen patients (35%) remain alive, but only 9 (24%) of them in remission. It has to be noted that the median time of follow-up among survivors is only 4 months (range, 2-27 months). The median time to death was 4 months (range, <1-21 months). Causes of death included organ failure (42%), infection (17%), interstitial pneumonitis (12%), progression of disease (8%), GVHD (4%), and other (17%). Actuarial survival at 1 year is 22%.

**Table 5.** Characteristics of Patients Reported to the International Bone Marrow Transplant Registry Who Underwent Allogeneic Transplant After Autologous Transplant for Hodgkin's Disease

Patients, <i>n</i>	37
Median age, y (range)	27 (17-38)
Karnofsky performance score >90, %	46
Donor-recipient match, %	
HLA-identical sibling	70
Matched unrelated	16
Haploidentical	11
Identical twin	3
Incidence of grade II-IV GVHD, %	29

## DISCUSSION

Conventional radiotherapy or chemotherapy can cure the majority of patients with HD. Even patients who fail to respond to induction chemotherapy and patients who relapse after chemotherapy can attain prolonged remissions after autoHSCT. Despite the success in treating HD, a significant number of patients—especially patients with primary refractory HD—do not benefit from autoHSCT, mostly because of progression of the disease after autologous transplantation. Patients with initial remission durations of <1 year failed to benefit from autologous transplantation (44% to 68%), most of the time because of progressive disease. Even in the more favorable cohort of patients with initial remission durations of >1 year, 15% to 43% of patients failed to attain prolonged remissions after autologous stem cell transplantation. Patients with primary refractory HD have even a lower probability of obtaining a durable remission. As many as 73% of patients who did not attain an initial complete remission will not benefit from autoHSCT. Due to the large number of autoHSCT performed worldwide for HD, physicians will be increasingly faced with patients who relapse after this procedure.

Because alloHSCT has the advantages over autoHSCT of a graft free of tumor and the graft-vs.-tumor effect, it has been used as treatment of relapsed or primary refractory HD. Single-institution reports, as well as registry data, suggest that patients treated with alloHSCT for relapsed or refractory HD have a lower relapse rate posttransplantation, but that this beneficial effect is offset by the higher treatment-associated mortality observed after alloHSCT. In addition, a case-controlled study by the EBMT did not demonstrate an advantage of alloHSCT over autoHSCT in terms of progression-free survival, relapse, and nonrelapse mortality.<sup>22</sup> The report by Gajewski et al.<sup>21</sup> analyzing a large number of patients who underwent bone marrow transplants from HLA-identical siblings reported to the IBMTR only showed a 15% disease-free survival at 3 years. Based on these studies, alloHSCT should not be routinely recommended to patients with HD. An exception to this approach could include patients with bone marrow involvement at the time of transplantation.

Allogeneic hematopoietic stem cell transplantation has been used in patients who relapse after autoHSCT in an effort to exploit the graft-vs.-tumor effect. There are few reports of patients treated with alloHSCT after failing an autologous transplant for HD. Nevertheless, several similarities between these reports can be established. First, the patients who underwent alloHSCT after autoHSCT are young. The median age in the report of Tsai et al.<sup>25</sup> was 32 years; it was 27 years in the IBMTR analysis. Given the toxicity of allogeneic transplantation in heavily pretreated patients who have already failed an autologous transplant, it is likely that this procedure is offered mostly to young patients with no coexisting medical problems. Second, the treatment-related mortality is extremely high. In the report

of Tsai et al., the treatment-related mortality was 90%; in the IBMTR experience, it was 75%. In both reports, most deaths occurred early, with a median time to death of 5.3 weeks in the report of Tsai et al. and 4 months in the IBMTR experience. This probably indicates that most deaths were related to infectious complications and organ toxicity and not to relapse or GVHD. The third and most important similarity is that few patients appear to benefit from this approach. In the report from the IBMTR, neither of the 2 patients with HD who underwent allogeneic transplantation after failing an autologous transplant were alive at the time of the report. In the report by Tsai et al., only 1 of 10 patients was alive at the time of the report. This patient remained free of disease 2 years after a 1-antigen-mismatched related transplant. In the IBMTR experience, only 9 of 47 patients remained in remission at the time of analysis. Although this represents 24% of the patients, it has to be kept in mind that the median time of follow-up among survivors is only 4 months (lead follow-up, 27 months) and that most of these patients remain at high risk of relapse.

Although the prognosis of patients with lymphoma who do not respond or who relapse after autologous transplant is extremely poor, several reports suggest that a small proportion of patients can attain prolonged remissions with additional radiotherapy or chemotherapy posttransplantation. Vose et al.<sup>24</sup> reviewed the outcome of 95 patients with HD who relapsed after autoHSCT. Ten patients (11%) remained alive and free of disease at the time of their report. Although 7 patients had been free of disease for <1 year, 2 patients enjoyed remissions of >2 years, and 1 had been disease free for 4 years.

The Seattle group reported the outcome of patients who relapsed after autologous transplantation for lymphoma.<sup>26</sup> Ten of 62 patients benefited from further chemotherapy and/or local radiotherapy. In a more recent follow-up, this group reported a median survival >5 years (range, 2.6–8 years) for these 10 patients.<sup>27</sup> Four patients remained alive without disease progression.

These studies suggest that additional treatment in patients who relapse after an autograft can produce prolonged remissions in a small proportion of patients.

It will be important to analyze a larger number of patients who have undergone alloHSCT after failing autoHSCT and to follow up on the patients who remain free of disease in the IBMTR database. Nevertheless, it is unlikely that a large number of patients will benefit from this approach. The use of nonmyeloablative conditioning regimens should be studied in patients who relapse or do not respond to autoHSCT, since these regimens appear to be better tolerated. This is particularly attractive in patients in whom an alloHSCT is being considered after failing a previous autoHSCT, since many patients die early after this procedure because of infections or organ failure.

In conclusion, a small proportion of patients appear to benefit from alloHSCT after failing autoHSCT. The mortality associated with this approach is extremely

high. New approaches for patients who do not respond or who relapse after an autoHSCT are necessary.

## REFERENCES

1. Urba WJ, Longo DL. Medical progress: Hodgkin's disease. *N Engl J Med* 326:678-687, 1992.
2. Marshall NA, DeVita VT Jr. Hodgkin's disease and transplantation: a room with a (non-transplanter's) view. *Semin Oncol* 26:67-73, 1999.
3. Fisher RI, DeVita VT, Hubbard SP, Simon R, Young RC. Prolonged disease-free survival in Hodgkin's disease with MOPP reinduction after first relapse. *Ann Intern Med* 90:761-763, 1979.
4. Longo DL, Duffey PL, Young PC, et al. Conventional-dose salvage combination chemotherapy in patients relapsing with Hodgkin's disease after combination chemotherapy. *J Clin Oncol* 10:210-218, 1992.
5. Chopra R, McMillan AK, Linch DC, et al. The place of high-dose BEAM therapy and autologous bone marrow transplantation in poor-risk Hodgkin's disease: a single center eight-year study of 155 patients. *Blood* 81:1137-1145, 1993.
6. Reece DE, Connors JM, Spinelli JJ, et al. Intensive therapy with cyclophosphamide, carmustine  $\pm$  cisplatin and autologous bone marrow transplantation for Hodgkin's disease in first relapse after combination chemotherapy. *Blood* 83:1193-1199, 1994.
7. Nademanee A, O'Donnell MR, Snyder DS, et al. High-dose chemotherapy with or without total body irradiation followed by autologous bone marrow and/or peripheral blood stem cell transplantation for patients with relapsed and refractory Hodgkin's disease: results in 85 patients with analysis of prognostic factors. *Blood* 85:1381-1390, 1995.
8. Yuen AR, Rosenberg SA, Hoppe RT, Halpern JD, Horning SA. Comparison between conventional salvage chemotherapy and high-dose therapy with autografting for recurrent or refractory Hodgkin's disease. *Blood* 89:814-822, 1997.
9. Horning SJ, Chao NJ, Negrin RS, et al. High-dose therapy and autologous hematopoietic progenitor cell transplantation for recurrent or refractory Hodgkin's disease: analysis of the Stanford University results and prognostic indices. *Blood* 89:801-813, 1997.
10. Bierman PJ, Anderson JR, Freeman MB, et al. High-dose chemotherapy followed by autologous hematopoietic rescue for Hodgkin's disease patients following first relapse after chemotherapy. *Ann Oncol* 7:151-156, 1996.
11. Phillips GL, Wolff SN, Herzig RH, et al. Treatment of progressive Hodgkin's disease with intensive chemoradiotherapy and autologous bone marrow transplantation. *Blood* 73:2086-2092, 1990.
12. Gianni AM, Siena S, Bregni M, et al. High-dose sequential chemotherapy with peripheral progenitor cell support for relapsed or refractory Hodgkin's disease: a 6-year update. *Ann Oncol* 4:889-891, 1993.
13. Reece DE, Barnett MJ, Shepherd JD, et al. High-dose cyclophosphamide, carmustine (BCNU), and etoposide (VP16-213) with or without cisplatin (CBV  $\pm$  P) and autologous transplantation for patients with Hodgkin's disease who fail to enter a complete remission after combination chemotherapy. *Blood* 86:451-456, 1995.

14. Lazarus HM, Rowlings PA, Zhang MJ, et al. Autotransplants for Hodgkin's disease in patients never achieving remission: a report from the Autologous Blood and Marrow Transplant Registry. *J Clin Oncol* 17:534-545, 1999.
15. Sweetenham JW, Carella AM, Taghipour G, et al. High-dose therapy and autologous stem-cell transplantation for adult patients with Hodgkin's disease who do not enter remission after induction chemotherapy: results in 175 patients reported to the European Group for Blood and Marrow Transplantation. Lymphoma Working Party. *J Clin Oncol* 17: 3101-3109, 1999.
16. Appelbaum FR, Sullivan KM, Thomas ED, et al. Allogeneic marrow transplantation in the treatment of MOPP-resistant Hodgkin's disease. *J Clin Oncol* 3:1490-1494, 1985.
17. Phillips GL, Reece DE, Barnett MJ, et al. Allogeneic marrow transplantation for refractory Hodgkin's disease. *J Clin Oncol* 7:1039-1045, 1989.
18. Lundberg JH, Hansen RM, Chitambar CR, et al. Allogeneic bone marrow transplantation for relapsed and refractory lymphoma using genotypically HLA-identical and alternative donors. *J Clin Oncol* 9:1848-1859, 1991.
19. Jones RJ, Piantadosi S, Mann RB, et al. High-dose cytotoxic therapy and bone marrow transplantation for relapsed Hodgkin's disease. *J Clin Oncol* 8:527-537, 1990.
20. Anderson JE, Litzow MR, Appelbaum FR, et al. Allogeneic, syngeneic and autologous marrow transplantation for Hodgkin's disease: the 21-year Seattle experience. *J Clin Oncol* 11:2342-2350, 1993.
21. Gajewski JL, Phillips GL, Sobocinski KA, et al. Bone marrow transplants from HLA-identical siblings in advanced Hodgkin's disease. *J Clin Oncol* 14:572-578, 1996.
22. Milpied N, Fielding AK, Pearce RM, Ernst P, Goldstone AH. Allogeneic bone marrow transplant is not better than autologous transplant for patients with relapsed Hodgkin's disease. European Group for Blood and Marrow Transplantation. *J Clin Oncol* 14: 1291-1296, 1996.
23. Vandenberghe E, Pearce R, Taghipour G, Fouillard L, Goldstone AH. Role of second transplant in the management of poor prognosis lymphomas: a report from the European Blood and Marrow Registry. *J Clin Oncol* 15:1595-1600, 1997.
24. Vose JM, Bierman PJ, Anderson JR, et al. Progressive disease after high-dose chemotherapy and autologous transplantation for lymphoid malignancy: clinical course and patient follow-up. *Blood* 80:2142-2148, 1992.
25. Tsai T, Goodman S, Saez R, et al. Allogeneic bone marrow transplantation in patients who relapse after autologous transplantation. *Bone Marrow Transplant* 20:859-863, 1997.
26. Petersen FB, Appelbaum FR, Hill R, et al. Autologous marrow transplantation for malignant lymphoma: a report of 101 cases from Seattle. *J Clin Oncol* 8:638-647, 1990.
27. Weaver CH, Appelbaum FR, Petersen FB, Bucker CD. Follow-up report on the outcome of patients relapsing after autologous marrow transplantation for malignant lymphoma [letter]. *J Clin Oncol* 11:812-813, 1993.

# Late Complications of Autologous Transplantation for Hodgkin's Disease

**J.D. Robertson, R. Chopra**

*Department of Experimental Haematology (J.D.R., R.C.), The Paterson Institute  
for Cancer Research; Department of Medical Oncology (R.C.),  
Christie Hospital NHS Trust, Manchester, UK*

## ABSTRACT

High-dose therapy with autologous stem cell rescue has become the accepted therapy for patients with advanced Hodgkin's disease (HD) who have failed one or more chemotherapy/radiotherapy regimens. It is also being used in some first complete remission (CR) patients at high risk of relapse. With transplant-related mortality rates of ~5%, the survival probability for HD patients has significantly increased, bringing into focus the long-term risks of treatment. To design future protocols, it is important to accurately define the additional risks imposed by the transplant procedure, given that the patients will have received prior radiotherapy and multiple courses of combination chemotherapy. We reviewed the evidence for such risks and examined current strategies to reduce them.

Fertility is an important issue in HD, as many of the patients are young adults or children. The majority of male patients lose their fertility during conventional treatment, and high-dose therapy may be associated with additional problems such as erectile dysfunction due to microangiopathy. The ovary is slightly more resistant to chemotherapy than the testis, but high-dose therapy, despite small numbers of reported normal pregnancies, is likely to cause ovarian failure. A number of strategies are under investigation to minimize the likelihood of infertility, including embryo storage after in vitro fertilization, cryopreservation of ovarian tissue, and the use of nonmyeloablative conditioning regimens.

Cardiopulmonary complications are a major cause of morbidity and mortality following high-dose therapy. BCNU, cyclophosphamide, and total body irradiation (TBI) have all been shown to induce noninfectious pulmonary complications. There is evidence that cyclophosphamide may exacerbate the toxic effect of BCNU, and that doses of BCNU >600 mg/m<sup>2</sup> are associated with a higher incidence of complications. Identifiable risk factors for lung damage include a history of lung disease or smoking, prior treatment with bleomycin or chest radiotherapy, and female sex. The role of steroids remains to be fully defined.

Radiotherapy and alkylating agents are carcinogenic; the risks of developing second malignancies following high-dose treatment have been widely reported. Solid tumors (mainly breast, lung, and gastrointestinal tumors) account for the majority of secondary cancers, but the relative risk of developing myelodysplastic syndrome/acute myeloid leukemia (MDS/AML) following treatment for HD is also increased. Risk factors include prior use of alkylating agents, patient age, previous radiotherapy, female sex, and (more controversially) prior splenectomy and use of peripheral blood stem cells. Telomere shortening, well documented after transplantation procedures, has been suggested as a possible cause of stem cell exhaustion and MDS. However, we have not found any association between telomere length and either MDS following transplantation or the development of clonal hematopoiesis and believe that it is unlikely to be the cause. Furthermore, a number of recent studies have suggested that the risk of developing MDS is no greater after high-dose therapy than after conventional chemotherapy.

We conclude that many of the complications following autologous transplantation in HD are extensions of those seen after conventional therapy and, in general, the benefits of this treatment outweigh the risks. The improved characterization of risk factors should allow the development of tailor-made protocols to further improve the outcome for HD patients.

## INTRODUCTION

Whereas the overall prognosis for patients with advanced Hodgkin's disease is good, there exists a subset of patients who will fail induction therapy or relapse following chemotherapy.<sup>1-3</sup> The results of conventional salvage therapy for such patients have been poor.<sup>4</sup> High-dose therapy with autologous bone marrow transplantation (autoBMT) and, more recently, peripheral blood stem cell transplantation (PBSCT), have been used as second-line therapy for more than 10 years in such patients. A number of series have been reported<sup>5-15</sup> which—although difficult to compare directly because of variation in patient selection, induction and conditioning regimens, and definition of outcomes—generally demonstrate that this approach is safe (<10% transplant-related mortality), allowing the possibility of long-term disease-free survival in ~50% of patients. As the prognosis for patients with HD has improved, concerns have been raised about the late complications of therapy. This review presents some key advances in our understanding of long-term complications and examines some of the potential underlying mechanisms for the development of MDS/AML after stem cell transplantation.

Donaldson et al.<sup>16</sup> recently reported 2617 consecutive HD patients treated at Stanford over a 40-year period and found the projected actuarial overall survival to be 94% in the cohort presenting between 1990–1999 compared with 20% in the 1960–1969 cohort. The investigators found that 45% of the deaths were due to HD



and, of the remainder, 20% were due to new cancers and 14% to cardiovascular disease. Analysis of risk factors demonstrated that the most serious late effects were associated with high doses of radiation administered in large fractions over extended fields and often combined with long-duration chemotherapy regimens involving toxic agents. Because such treatments are no longer in general use, the incidence of complications related to conventional therapy may be predicted to fall in the future. A similar range of complications has been described following autologous transplantation for HD. It is of considerable importance to accurately quantify the additional risk imposed by the transplant procedure itself and to weigh this risk against the benefits of the therapy at the present time and against future requirements for protocol modification to address the current high relapse rate.

The toxicity of the conditioning regimen has been implicated as the main cause of the complications of high-dose therapy. A variety of conditioning regimens have been used in the reported series and may be divided into those that include TBI and those that do not. The use of TBI in HD is often restricted, because many patients will have received prior radiotherapy. No prospective randomized trials have been carried out to directly compare different conditioning regimens, but a number of studies have failed to show significant differences in overall survival (OS) or event-free survival (EFS) between patients treated with TBI-containing or chemotherapy-based conditioning regimens.<sup>8,11,17</sup> Concerns have existed about the use of TBI because of its leukemogenicity<sup>18</sup> and the possibility of increased pulmonary toxicity,<sup>13</sup> and most centers have preferred to use chemotherapy-based regimens. The two most commonly used chemotherapy-based regimens are CBV (cyclophosphamide, BCNU, and etoposide, at varying doses) and BEAM (BCNU, etoposide, cytosine arabinoside, and melphalan). High doses of BCNU (>600 mg/m<sup>2</sup>), however, have also been associated with increased incidence of interstitial pneumonitis,<sup>17,19-21</sup> and dose escalation of etoposide has resulted in severe gastrointestinal toxicity.<sup>22</sup> In addition, the use of cyclophosphamide has been shown to exacerbate the pulmonary toxicity of BCNU,<sup>23</sup> and both TBI and alkylating agents cause infertility.

Infertility is a major issue in the treatment of HD because the majority of the patients are treated as young adults. Radiation impairs gonadal function in a dose-dependent and (in women) age-dependent manner. Spermatogenesis is exquisitely sensitive to radiation. Ovarian function is less so, as fewer cell divisions occur, but it is estimated that half of the follicles are lost at a radiation dose of 4 Gy.<sup>24</sup> Additionally, there is a higher risk of spontaneous abortion, preterm labor, and low-birth-weight infants in women who have undergone previous abdominal radiotherapy, presumably because of the effect of radiation on the uterus.<sup>25-27</sup> TBI causes permanent gonadal damage, although in a few patients, recovery is possible after some years.<sup>28</sup> Chemotherapy effects on gonadal function are agent, dose, and age dependent, with combinations more damaging than single agents. Alkylating

agents produce severe damage to oogonia and the seminiferous epithelia.<sup>29</sup> Platinum compounds, vinblastine, bleomycin, and adriamycin all have mutagenic effects in oocytes.<sup>30,31</sup> High-dose therapy almost invariably results in gonadal failure. It has been demonstrated that testicular and ovarian damage is detectable within 12–24 hours of the BMT conditioning regimen, whether TBI- or chemotherapy-based.<sup>32,33</sup> A recent report of 69 patients undergoing myeloablative therapy and BMT found that ovarian failure was induced in all but 5 patients, and there was no correlation with age, conditioning regimen, or suppression of endogenous hormonal secretion during BMT.<sup>34</sup> Even when recovery of menstruation and pregnancies occur, the patients remain at risk of premature menopause due to follicular depletion.<sup>35</sup> In male BMT recipients, there is evidence for germ-cell damage and Leydig cell insufficiency,<sup>36</sup> and more recently, cavernosal artery insufficiency has been identified as a major cause of erectile dysfunction following high-dose chemotherapy and TBI.<sup>37</sup> The probability of recovery of spermatogenesis following myeloablative therapy is extremely low.

A number of strategies have been employed to reduce the impact of infertility following transplantation. Semen collection and cryopreservation is a possibility for postpubertal males, and with techniques such as intracytoplasmic sperm injection, fewer numbers of spermatozoa are required for successful fertilization. However, the take-up rate appears to be low. A recent study of prolonged follow-up of 115 male HD patients found that only 33 had used their stored gametes, and only 8 of those had had a successful subsequent live birth (Blackhall FH, Atkinson AD, Maaya MB, et al., unpublished data). For women, superovulation and embryo cryopreservation is an option before the commencement of chemotherapy, but requires ~1 month to complete and the presence of a male partner. It also raises a number of complex ethical issues. In some patients with ovarian failure who received chemotherapy-based conditioning regimens, it has been possible to induce ovulation and pregnancy by hormone manipulation.<sup>38</sup> More recently, there has been considerable interest in the possibility of cryopreserving ovarian tissue before receiving high-dose chemotherapy, following successful animal models. This procedure has been carried out in a number of women. The potential risk of reimplanting malignant cells with the tissue is under investigation in NOD/SCID mice, although this is believed to be low in HD patients; a recent study of patients with advanced HD failed to demonstrate any evidence of minimal residual disease in the ovary.<sup>34</sup> A similar strategy is under investigation in men, the harvesting and cryopreservation of testicular tissue as a cell suspension before commencing treatment, for re-injection after therapy is completed.

A simpler approach to the problem of infertility is to limit the exposure of the patient to radiation and alkylating agents. The role of TBI-containing conditioning regimens, in the absence of convincing evidence of their superiority in terms of survival, should be challenged in this respect. Similarly, less toxic chemotherapy

regimens require evaluation. Jackson et al.,<sup>39</sup> for example, reported that the use of melphalan and etoposide conditioning was associated with a 5-year EFS of 60% in second CR HD while preserving ovarian function.

Cardiac and pulmonary toxicity are major causes of morbidity and mortality following high-dose therapy. Both are multifactorial in origin. Pulmonary complications may result from infection secondary to immune suppression, and several agents, including TBI, BCNU, and cyclophosphamide, cause noninfectious pulmonary complications.<sup>40</sup> The lungs are extremely sensitive to radiation, and TBI has long been implicated as a major cause of posttransplant pulmonary fibrosis.<sup>13</sup> BCNU causes toxic lung reactions, characterized by chronic interstitial fibrosis and a reduction in pulmonary diffusion capacity, in a dose-dependent manner.<sup>13,41</sup> A number of investigators have identified a BCNU dose of 600 mg/m<sup>2</sup> at or above which the incidence of interstitial pneumonitis is significantly increased.<sup>17,19-21</sup> However, lung toxicity may occur at lower doses in patients with a history of mediastinal irradiation<sup>21</sup> or those undergoing concurrent treatment with cyclophosphamide.<sup>23</sup> Other identified risk factors include a history of lung disease or smoking,<sup>42</sup> female sex,<sup>23,43</sup> and previous treatment with bleomycin.<sup>44</sup> It is of note that abnormalities of pulmonary function tests have been identified in up to 60% of patients undergoing high-dose therapy before the transplant procedure,<sup>45</sup> although in the majority of cases, abnormalities were mild or moderate, and only severe defects were found to be predictive for the subsequent development of pulmonary complications. Steroids have been demonstrated to improve the outcome of BCNU-induced lung toxicity in terms of symptom relief and diffusion capacity.<sup>46</sup> The timing of treatment has been controversial, but the effects appear to be more beneficial when started promptly at the onset of symptoms or reduction in diffusion capacity.<sup>23,47</sup> The prophylactic use of steroids remains controversial and requires a prospective randomized trial for validation.

Cardiac toxicity is a consequence of radiotherapy, and a number of chemotherapy agents, the most important group being the anthracyclines,<sup>48</sup> which are used in the induction regimens for HD but not in conditioning regimens for high-dose therapy. Apart from the use of TBI-containing regimens, therefore, this complication is more likely to be a result of conventional chemotherapy rather than the transplant procedure per se. The risk factors for anthracycline toxicity include cumulative dose and dose intensity,<sup>49,50</sup> preexisting heart disease or hypertension,<sup>49</sup> and mediastinal irradiation.<sup>51</sup> The clinical presentation is variable, ranging from acute cardiomyopathy to a spectrum of cardiac failures presenting years after the initial treatment. The mechanism of the cardiac toxicity is likely to be generation of free radicals.<sup>52</sup> A number of possible cardioprotective agents have been investigated, including metal-chelators, which, by reducing the availability of intracellular iron and other metals to form complexes with the anthracyclines, may reduce the probability of free-radical formation and subsequent cardiac damage.

One agent, ICRF-187 (dexrazoxane), has undergone clinical trials, mainly in patients with advanced breast cancer, and preliminary data have been encouraging,<sup>53</sup> with a reduction in the incidence of acute cardiotoxicity. Other approaches include the investigation of anthracycline analogs and the use of liposomes for anthracycline delivery.

Secondary malignancies are a recognized risk of treatment for HD, with or without high-dose chemotherapy and stem cell transplantation. In 1996, Hancock and Hoppe reported the Stanford experience of secondary cancers among 2162 consecutive HD patients presenting between 1960 and 1990.<sup>54</sup> The relative risk (RR) of developing any cancer increased with time of follow-up, from 1.5 at <5 years to 5.6 for those with >20 years of follow-up. The risk was greatest for those treated when young. The distribution of tumors reflected that in the general population lung, breast, and melanoma were the most common, although relative risks for soft-tissue sarcomas and salivary gland tumors were particularly high. Breast cancer has been particularly linked to early age of treatment and the dose of radiation received by the mediastinum.<sup>55</sup> The British National Lymphoma Investigation (BNLI) recently reported on a cohort of 5519 patients treated between 1963 and 1993.<sup>56</sup> The findings were similar, although a higher absolute risk of developing gastrointestinal cancers was described. In addition, the relative risks of developing different tumors were calculated for different treatment modalities. Lung cancer risk was increased after all types of treatment, breast cancer was more common after radiotherapy alone, and gastrointestinal tumors were more common after mixed-modality treatments.

The relative risk of developing secondary leukemia and myelodysplasia is high following treatment for HD. The Stanford cohort had an RR of 37.7, with a 2.3% projected actuarial risk of leukemia over a 35-year period. This risk was highest within the first 10 years of exposure to alkylating agents (especially nitrogen mustard), procarbazine, and etoposide. The relative risk of developing leukemia was not found to be related to age at treatment, in contrast to the BNLI study, which additionally linked leukemia to chemotherapy and mixed-modality treatments. However, these studies did not address the issue of autologous transplantation in HD. A number of initial small studies addressing this issue reported an alarmingly high actuarial risk of MDS/leukemia following transplantation (15–18% at 6 years).<sup>57,58</sup> It is extremely important to determine whether the autografting procedure significantly increases this risk or whether the risk is due mainly to prior exposure to leukemogenic agents. The European Group for Blood and Marrow Transplantation (EBMT) recently reported a retrospective questionnaire study of 131 centers representing 4998 patients who had undergone autologous transplantation for lymphoma, including 1715 patients with HD. The actuarial risk of developing MDS/AML at 5 years posttransplant was 4.6% for HD. Risk factors included older age at transplant, radiotherapy in the conditioning regimen, number

of transplants, time between diagnosis and transplant, and female sex. There was no increased risk associated with autologous PBSC transplants as opposed to bone marrow transplants, although this had been previously suggested.<sup>58</sup> The actuarial 5-year risk was not dissimilar to the incidence of MDS/AML after conventional therapy,<sup>59–61</sup> and similar findings were reported by the French registry study.<sup>60</sup> Harrison et al.<sup>62</sup> undertook a retrospective comparative study of 4576 HD patients from the BNLI and University College London Hospital databases, including 595 who had undergone autologous transplantation with BEAM. The most important risk factors for the subsequent development of MDS/AML were the quantity of prior chemotherapy regimens and exposure to MOPP (mechlorethamine, vincristine, procarbazine, and prednisone) or lomustine. Multivariate analysis revealed a nonsignificant relative risk association with the transplant procedure itself.

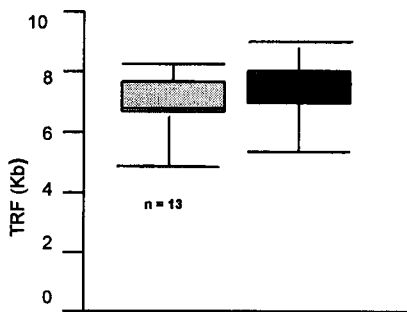
Possible mechanisms for the development of MDS/AML include cumulative damage to stem cells by previous courses of chemotherapy, but it is possible that the transplant procedure itself may play a role. There has recently been considerable interest in the phenomenon of accelerated telomere shortening that has been described following autologous and allogeneic transplantation.<sup>63–67</sup> This results from the increased replicative stress in the hematopoietic system following myeloablative therapy, and concerns have been raised that it may lead to stem cell exhaustion. Telomeres are tandemly repeated DNA sequences (TTAGGG in humans) that protect the ends of chromosomes and are important in maintaining their length.<sup>68,69</sup> Because DNA polymerases cannot completely replicate a linear DNA molecule, ~50–100 base pairs of telomeric DNA at the end of a chromosome are lost with each cell division.<sup>70</sup> Critical shortening of telomeres is associated with cellular senescence *in vitro*.<sup>71</sup> In malignant cells, on the other hand, critical telomere shortening is avoided by the activation of telomerase, a unique cellular reverse transcriptase that can extend the TTAGGG repeat.<sup>72</sup> This is one mechanism by which such cells can bypass senescence and attain immortality.<sup>73</sup> Thus, the majority of cancers have short but stable telomeres, which allows them to escape senescence but contributes to the genomic instability that characterizes the condition. Telomere shortening with aging of individuals has been demonstrated *in vivo* in skin, blood, and colonic mucosa.<sup>74–76</sup> This has raised concerns that telomere shortening may contribute to the increased incidence of clonal disorders such as myelodysplasia as well as malignancy in the elderly. In a large cohort of patients with MDS, short telomeres correlated with the presence of poor risk factors and likelihood of transformation into AML.<sup>77</sup> In acute leukemias, telomere length is short and telomerase levels are high, as discussed above.<sup>78</sup>

Sequential samples from large numbers of patients undergoing transplantation are required to adequately address the issue of whether posttransplant telomere shortening has a causative role in the development of secondary MDS/AML. However, there are indications that this is not likely to be the case. First, it has been

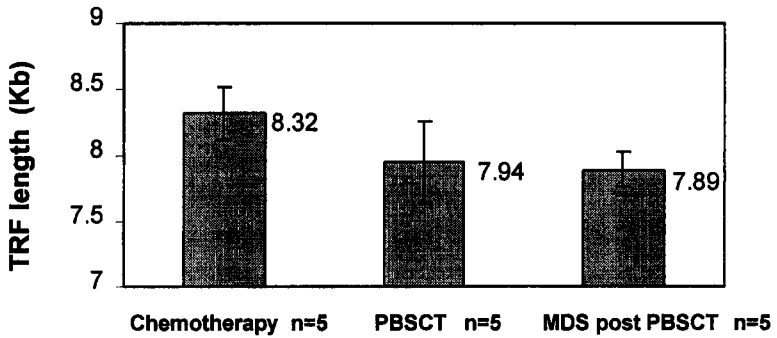
shown that the onset of posttransplant MDS/AML can be predicted by the development of oligoclonal hematopoiesis in some patients. This is detected by the presence of skewed X-chromosome inactivation patterns (XCIPs) in informative women. Studies in hematologically normal females using XCIPs have demonstrated that normal hematopoiesis becomes increasingly skewed with age.<sup>79</sup> We have shown that this acquired skewing of XCIPs occurs independently of telomere shortening, suggesting that it is not the critical shortening of the telomere that is driving stem cell depletion<sup>80</sup> (Figure 1). Second, we have undertaken a study in AML comparing 5 patients who underwent chemotherapy alone with 5 who underwent autologous PBSCT in first CR and a further group of 5 patients who developed secondary myelodysplasia following transplantation (Figure 2). There was no significant difference in mean telomere length between these groups, although the numbers were small and the data are preliminary. Third, we have compared the telomere length of bone marrow harvest cells with that of peripheral blood neutrophils sampled at a median of 5 years' follow-up following transplantation in 6 patients with HD (Figure 3). We failed to show a significant degree of shortening. All patients received BEAM, which may be less myeloablative than the TBI-containing regimens in other studies of posttransplant telomere shortening<sup>63-67</sup> and may thus impose less replicative stress on the hematopoietic system in marrow reconstitution.

## CONCLUSIONS

The clinical data published so far suggest that chemotherapy before stem cell transplantation is the most important risk factor in the development of therapy-

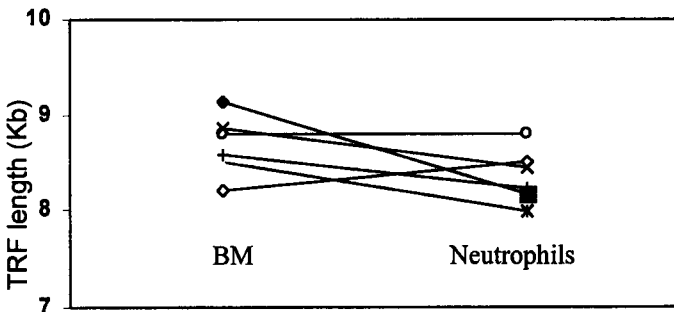


**Figure 1.** Comparison of telomere (TRF) length in healthy females older than 70 years with balanced (left) or skewed (right) X-chromosome inactivation patterns (XCIPs) (>75% expression of 1 allele). The mean TRF value for those with balanced XCIPs was  $7.36 \pm 0.32$  kb and  $7.76 \pm 0.3$  kb for those with skewed XCIPs. There was no statistically significant difference between these groups.



**Figure 2.** Comparison of mean telomere (TRF) length in 3 groups of patients following conventional and high-dose chemotherapy for AML. The median ages of the groups were similar (37, 41, and 43 years). Means and standard errors are shown. There was no significant difference in TRF length between the groups.

associated MDS/AML. This raises the possibility to decrease such long-term complications by using earlier dose intensification in poor-risk patients. The challenge will be to establish reproducible prognostic indicators that can identify patients with Hodgkin's disease likely to have recurrent or refractory disease. Our studies, presented here, suggest that the transplant procedure per se, and the replicative stress imposed on the infused stem cells, is not the primary mechanism for development of MDS/AML. Furthermore, the use of telomere length to detect



**Figure 3.** Sequential telomere (TRF) measurements in 6 patients (median age 29 years) undergoing BEAM (BCNU, etoposide, cytosine arabinoside, and melphalan)/autologous bone marrow transplantation therapy for Hodgkin's disease with a median follow-up time of 5 years. The initial sample was taken from the bone marrow harvest. The mean degree of TRF shortening detected was 0.35 kb but was not significant ( $P=.12$ ).

early progression to MDS may not be feasible due to the wide variations seen in patients after transplant. Why some individuals develop MDS/AML may be related to a number of genetic factors, and we are currently studying the relationship between antioxidant enzyme levels and secondary leukemia. Other strategies to prevent DNA damage resulting from alkylating agents may be to use chemoprotective agents. There is initial evidence that macrophage inflammatory protein (MIP)-1 $\alpha$  may attenuate the toxic effects of some alkylating agents in human bone marrow cells.<sup>80</sup>

## REFERENCES

1. Canellos GP. Is there an effective salvage therapy for advanced Hodgkin's disease? *Ann Oncol* 2 (Suppl 1):1-7, 1991.
2. Bonfante V, Santoro A, Viviani S, et al. Outcome of patients with Hodgkin's disease failing after primary MOPP-ABVD. *J Clin Oncol* 15:528-534, 1997.
3. Longo DL, Young RC, Wesley M, et al. Twenty years of MOPP therapy for Hodgkin's disease. *J Clin Oncol* 4:1295-1306, 1986.
4. Longo DL, Duffey PL, Young RC, et al. Conventional-dose salvage combination chemotherapy in patients relapsing with Hodgkin's disease after combination chemotherapy: the low probability for cure. *J Clin Oncol* 10:210-218, 1992.
5. Majolino I, Pearce R, Taghipour G, Goldstone AH. Peripheral-blood stem-cell transplantation versus autologous bone marrow transplantation in Hodgkin's and non-Hodgkin's lymphomas: a new matched-pair analysis of the European Group for Blood and Marrow Transplantation Registry Data. Lymphoma Working Party of the European Group for Blood and Marrow Transplantation. *J Clin Oncol* 15:509-517, 1997.
6. Lancet JE, Rapoport AP, Brasacchio R, et al. Autotransplantation for relapsed or refractory Hodgkin's disease: long-term follow-up and analysis of prognostic factors. *Bone Marrow Transplant* 22:265-271, 1998.
7. Linch DC, Winfield D, Goldstone AH, et al. Dose intensification with autologous bone marrow transplantation in relapsed and resistant Hodgkin's disease: results of a BNLI randomised trial. *Lancet* 341:1051-1054, 1993.
8. Chopra R, McMillan AK, Linch DC, et al. The place of high-dose BEAM therapy and autologous bone marrow transplantation in poor-risk Hodgkin's disease: a single-center eight-year study of 155 patients. *Blood* 81:1137-1145, 1993.
9. Yuen AR, Rosenberg SA, Hoppe RT, Halpern JD, Horning SJ. Comparison between conventional salvage therapy and high-dose therapy with autografting for recurrent or refractory Hodgkin's disease. *Blood* 89:814-822, 1997.
10. Reece DE, Barnett MJ, Shepherd JD, et al. High-dose cyclophosphamide, carmustine (BCNU), and etoposide (VP16-213) with or without cisplatin (CBV  $\pm$  P) and autologous transplantation for patients with Hodgkin's disease who fail to enter a complete remission after combination chemotherapy. *Blood* 86:451-456, 1995.
11. Horning SJ, Chao NJ, Negrin RS, et al. High-dose therapy and autologous hematopoietic progenitor cell transplantation for recurrent or refractory Hodgkin's disease: analysis



- of the Stanford University results and prognostic indices. *Blood* 89:801–813, 1997.
12. Carella AM, Congiu AM, Gaozza E, et al. High-dose chemotherapy with autologous bone marrow transplantation in 50 advanced resistant Hodgkin's disease patients: an Italian study group report. *J Clin Oncol* 6:1411–1416, 1988.
  13. Phillips GL, Wolff SN, Herzig RH, et al. Treatment of progressive Hodgkin's disease with intensive chemoradiotherapy and autologous bone marrow transplantation. *Blood* 73:2086–2092, 1989.
  14. Lazarus HM, Crilley P, Ciobanu N, et al. High-dose carmustine, etoposide, and cisplatin and autologous bone marrow transplantation for relapsed and refractory lymphoma. *J Clin Oncol* 10:1682–1689, 1992.
  15. Crump M, Smith AM, Brandwein J, et al. High-dose etoposide and melphalan, and autologous bone marrow transplantation for patients with advanced Hodgkin's disease: importance of disease status at transplant. *J Clin Oncol* 11:704–711, 1993.
  16. Donaldson SS, Hancock SL, Hoppe RT. The Janeway lecture: Hodgkin's disease: finding the balance between cure and late effects. *Cancer J Sci Am* 5:325–333, 1999.
  17. Anderson JE, Litzow MR, Appelbaum FR, et al. Allogeneic, syngeneic, and autologous marrow transplantation for Hodgkin's disease: the 21-year Seattle experience. *J Clin Oncol* 11:2342–2350, 1993.
  18. Darrington DL, Vose JM, Anderson JR, et al. Incidence and characterization of secondary myelodysplastic syndrome and acute myelogenous leukemia following high-dose chemoradiotherapy and autologous stem-cell transplantation for lymphoid malignancies. *J Clin Oncol* 12:2527–2534, 1994.
  19. Ahmed T, Ciavarella D, Feldman E, et al. High-dose, potentially myeloablative chemotherapy and autologous bone marrow transplantation for patients with advanced Hodgkin's disease. *Leukemia* 3:19–22, 1989.
  20. Weaver CH, Appelbaum FR, Petersen FB, et al. High-dose cyclophosphamide, carmustine, and etoposide followed by autologous bone marrow transplantation in patients with lymphoid malignancies who have received dose-limiting radiation therapy. *J Clin Oncol* 11:1329–1335, 1993.
  21. Wheeler C, Antin JH, Churchill WH, et al. Cyclophosphamide, carmustine, and etoposide with autologous bone marrow transplantation in refractory Hodgkin's disease and non-Hodgkin's lymphoma: a dose-finding study. *J Clin Oncol* 8:648–656, 1990.
  22. Mills W, Strang J, Goldstone AH, Linch DC. Dose intensification of etoposide in the BEAM ABMT protocol for malignant lymphoma. *Leuk Lymphoma* 17:263–270, 1995.
  23. Alessandrino EP, Bernasconi P, Colombo A, et al. Pulmonary toxicity following carmustine-based preparative regimens and autologous peripheral blood progenitor cell transplantation in hematologic malignancies. *Bone Marrow Transplant* 25:309–313, 2000.
  24. Wallace WH, Shalet SM, Hendry JH, Morris Jones PH, Gattamaneni HR. Ovarian failure following abdominal irradiation in childhood: the radiosensitivity of the human oocyte. *Br J Radiol* 62:995–998, 1989.
  25. Sanders JE, Hawley J, Levy W, et al. Pregnancies following high-dose cyclophosphamide with or without high-dose busulfan or total-body irradiation and bone marrow transplantation. *Blood* 87:3045–3052, 1996.
  26. Li FP, Gimbrete K, Gelber RD, et al. Outcome of pregnancy in survivors of Wilms' tumor.

- JAMA* 257:216–219, 1987.
27. Hawkins MM, Smith RA. Pregnancy outcomes in childhood cancer survivors: probable effects of abdominal irradiation. *Int J Cancer* 43:399–402, 1989.
  28. Spinelli S, Chiodi S, Bacigalupo A, et al. Ovarian recovery after total body irradiation and allogeneic bone marrow transplantation: long-term follow up of 79 females. *Bone Marrow Transplant* 14:373–380, 1994.
  29. Warne GL, Fairley KF, Hobbs JB, Martin FI. Cyclophosphamide-induced ovarian failure. *N Engl J Med* 289:1159–1162, 1973.
  30. Sudman PD, Rutledge JC, Bishop JB, Generoso WM. Bleomycin: female-specific dominant lethal effects in mice. *Mutat Res* 296:143–156, 1992.
  31. Katoh MA, Cain KT, Hughes LA, Foxworth LB, Bishop JB, Generoso WM. Female-specific dominant lethal effects in mice. *Mutat Res* 230:205–217, 1990.
  32. Chatterjee R, Mills W, Katz M, McGarrigle HH, Goldstone AH. Germ cell failure and Leydig cell insufficiency in post-pubertal males after autologous bone marrow transplantation with BEAM for lymphoma. *Bone Marrow Transplant* 13:519–522, 1994.
  33. Chatterjee R, Mills W, Katz M, McGarrigle HH, Goldstone AH. Prospective study of pituitary-gonadal function to evaluate short-term effects of ablative chemotherapy or total body irradiation with autologous or allogeneic marrow transplantation in post-menarcheal female patients. *Bone Marrow Transplant* 13:511–517, 1994.
  34. Meirov D. Ovarian injury and modern options to preserve fertility in female cancer patients treated with high dose radio-chemotherapy for hemato-oncological neoplasias and other cancers. *Leuk Lymphoma* 33:65–76, 1999.
  35. Byrne J, Fears TR, Gail MH, et al. Early menopause in long-term survivors of cancer during adolescence. *Am J Obstet Gynecol* 166:788–793, 1992.
  36. Howell S, Shalet S. Gonadal damage from chemotherapy and radiotherapy. *Endocrinol Metab Clin North Am* 27:927–943, 1998.
  37. Chatterjee R, Kottaridis PD, Lees WR, Ralph DJ, Goldstone AH. Cavernosal arterial insufficiency and erectile dysfunction in recipients of high-dose chemotherapy and total body irradiation for multiple myeloma. *Lancet* 355:1335–1336, 2000.
  38. Chatterjee R, Mills W, Katz M, McGarrigle HH, Goldstone AH. Induction of ovarian function by using short-term human menopausal gonadotrophin in patients with ovarian failure following cytotoxic chemotherapy for haematological malignancy. *Leuk Lymphoma* 10:383–386, 1993.
  39. Jackson GH, Wood A, Taylor PR, et al. Early high dose chemotherapy intensification with autologous bone marrow transplantation in lymphoma associated with retention of fertility and normal pregnancies in females. Scotland and Newcastle Lymphoma Group, UK. *Leuk Lymphoma* 28:127–132, 1997.
  40. Kreisman H, Wolkove N. Pulmonary toxicity of antineoplastic therapy. *Semin Oncol* 19:508–520, 1992.
  41. Ager S, Mahendra P, Richards EM, Bass G, Baglin TP, Marcus RE. High-dose carmustine, etoposide and melphalan ('BEM') with autologous stem cell transplantation: a dose-toxicity study. *Bone Marrow Transplant* 17:335–340, 1996.
  42. Demirer T, Weaver CH, Buckner CD, et al. High-dose cyclophosphamide, carmustine, and etoposide followed by allogeneic bone marrow transplantation in patients with lym-

- phoid malignancies who had received prior dose-limiting radiation therapy. *J Clin Oncol* 13:596–602, 1997.
43. Lund MB, Kongerud J, Boe J, et al. Cardiopulmonary sequelae after treatment for Hodgkin's disease: increased risk in females? *Ann Oncol* 7:257–264, 1996.
  44. Todd NW, Peters WP, Ost AH, Roggli VL, Piantadosi CA. Pulmonary drug toxicity in patients with primary breast cancer treated with high-dose combination chemotherapy and autologous bone marrow transplantation. *Am Rev Respir Dis* 147:1264–1270, 1993.
  45. Jain B, Floreani AA, Anderson JR, et al. Cardiopulmonary function and autologous bone marrow transplantation: results and predictive value for respiratory failure and mortality. The University of Nebraska Medical Center Bone Marrow Transplantation Pulmonary Study Group. *Bone Marrow Transplant* 17:561–568, 1996.
  46. Kalaycioglu M, Kavuru M, Tuason L, Bolwell B. Empiric prednisone therapy for pulmonary toxic reaction after high-dose chemotherapy containing carmustine (BCNU). *Chest* 107:482–487, 1995.
  47. Rubio C, Hill ME, Milan S, ME OB, Cunningham D. Idiopathic pneumonia syndrome after high-dose chemotherapy for relapsed Hodgkin's disease. *Br J Cancer* 75:1044–1048, 1997.
  48. Hancock SL, Tucker MA, Hoppe RT. Factors affecting late mortality from heart disease after treatment of Hodgkin's disease. *JAMA* 270:1949–1955, 1993.
  49. Von Hoff DD, Layard MW, Basa P, et al. Risk factors for doxorubicin-induced congestive heart failure. *Ann Intern Med* 91:710–717, 1979.
  50. Sorensen K, Levitt G, Sebag Montefiore D, Bull C, Sullivan I. Cardiac function in Wilms' tumor survivors. *J Clin Oncol* 13:1546–1556, 1995.
  51. Steinherz LJ, Steinherz PG, Tan CT, Heller G, Murphy ML. Cardiac toxicity 4 to 20 years after completing anthracycline therapy. *JAMA* 266:1672–1677, 1991.
  52. Doroshow JH, Davies KJ. Redox cycling of anthracyclines by cardiac mitochondria, II: formation of superoxide anion, hydrogen peroxide, and hydroxyl radical. *J Biol Chem* 261:3068–3074, 1986.
  53. Swain SM, Whaley FS, Gerber MC, et al. Cardioprotection with dexrazoxane for doxorubicin-containing therapy in advanced breast cancer. *J Clin Oncol* 15:1318–1332, 1997.
  54. Hancock SL, Hoppe RT. Long-term complications of treatment and causes of mortality after Hodgkin's disease. *Semin Radiat Oncol* 6:225–242, 1996.
  55. Hancock SL, Tucker MA, Hoppe RT. Breast cancer after treatment of Hodgkin's disease. *J Natl Cancer Inst* 85:25–31, 1993.
  56. Swerdlow AJ, Barber JA, Hudson GV, et al. Risk of second malignancy after Hodgkin's disease in a collaborative British cohort: the relation to age at treatment. *J Clin Oncol* 218:498–509, 2000.
  57. Stone RM, Neuberg D, Soiffer R, et al. Myelodysplastic syndrome as a late complication following autologous bone marrow transplantation for non-Hodgkin's lymphoma. *J Clin Oncol* 12:2535–2542, 1994.
  58. Miller JS, Arthur DC, Litz CE, Neglia JP, Miller WJ, Weisdorf DJ. Myelodysplastic syndrome after autologous bone marrow transplantation: an additional late complication of curative cancer therapy. *Blood* 83:3780–3786, 1994.
  59. Hess CF, Kortmann RD, Schmidberger H, Bamberg M. How relevant is secondary

- leukaemia for initial treatment selection in Hodgkin's disease? *Eur J Cancer* 30a: 1441–1447, 1994.
60. Andre M, Henry Amar M, Blaise D, et al. Treatment-related deaths and second cancer risk after autologous stem-cell transplantation for Hodgkin's disease. *Blood* 92: 1933–1940, 1998.
  61. Swerdlow AJ, Douglas AJ, Vaughan Hudson G, Vaughan Hudson B, MacLennan KA. Risk of second primary cancer after Hodgkin's disease in patients in the British National Lymphoma Investigation: relationships to host factors, histology and stage of Hodgkin's disease, and splenectomy. *Br J Cancer* 68:1006–1011, 1993.
  62. Harrison CN, Gregory W, Hudson GV, et al. High-dose BEAM chemotherapy with autologous haemopoietic stem cell transplantation for Hodgkin's disease is unlikely to be associated with a major increased risk of secondary MDS/AML. *Br J Cancer* 81:476–483, 1999.
  63. Akiyama M, Hoshi Y, Sakurai S, Yamada H, Yamada O, Mizoguchi H. Changes of telomere length in children after hematopoietic stem cell transplantation. *Bone Marrow Transplant* 21:167–171, 1998.
  64. Lee J, Kook H, Chung I, et al. Telomere length changes in patients undergoing hematopoietic stem cell transplantation. *Bone Marrow Transplant* 24:411–415, 1999.
  65. Notaro R, Cimmino A, Tabarini D, Rotoli B, Luzzatto L. In vivo telomere dynamics of human hematopoietic stem cells. *Proc Natl Acad Sci U S A* 94:13782–13785, 1997.
  66. Wynn RF, Cross MA, Hatton C, et al. Accelerated telomere shortening in young recipients of allogeneic bone-marrow transplants. *Lancet* 351:178–181, 1998.
  67. Wynn R, Thornley I, Freedman M, Saunders EF. Telomere shortening in leucocyte subsets of long-term survivors of allogeneic bone marrow transplantation. *Br J Haematol* 105:997–1001, 1999.
  68. Moyzis RK, Buckingham JM, Cram LS, et al. A highly conserved repetitive DNA sequence, (TTAGGG)<sub>n</sub>, present at the telomeres of human chromosomes. *Proc Natl Acad Sci U S A* 85:6622–6626, 1988.
  69. Greider CW. Mammalian telomere dynamics: healing, fragmentation shortening and stabilization. *Curr Opin Genet Dev* 4:203–211, 1994.
  70. Olovnikov AM. A theory of marginotomy: the incomplete copying of template margin in enzymic synthesis of polynucleotides and biological significance of the phenomenon. *J Theor Biol* 41:181–190, 1973.
  71. Allsopp RC, Harley CB. Evidence for a critical telomere length in senescent human fibroblasts. *Exp Cell Res* 219:130–136, 1995.
  72. Blackburn EH, Greider CW, Henderson E, et al. Recognition and elongation of telomeres by telomerase. *Genome* 31:553–560, 1989.
  73. Counter CM, Avilion AA, LeFeuvre CE, et al. Telomere shortening associated with chromosome instability is arrested in immortal cells which express telomerase activity. *EMBO J* 11:1921–1929, 1992.
  74. Hastie ND, Dempster M, Dunlop MG, Thompson AM, Green DK, Allshire RC. Telomere reduction in human colorectal carcinoma and with ageing. *Nature* 346:866–868, 1990.
  75. Lindsey J, McGill NI, Lindsey LA, Green DK, Cooke HJ. In vivo loss of telomeric repeats with age in humans. *Mutat Res* 256:45–48, 1991.

76. Vaziri H, Dragowska W, Allsopp RC, Thomas TE, Harley CB, Lansdorp PM. Evidence for a mitotic clock in human hematopoietic stem cells: loss of telomeric DNA with age. *Proc Natl Acad Sci U S A* 91:9857–9860, 1994.
77. Ohyashiki JH, Iwama H, Yahata N, et al. Telomere stability is frequently impaired in high-risk groups of patients with myelodysplastic syndromes. *Clin Cancer Res* 5:1155–1160, 1999.
78. Ohyashiki JH, Ohyashiki K, Iwama H, Hayashi S, Toyama K, Shay JW. Clinical implications of telomerase activity levels in acute leukemia. *Clin Cancer Res* 3:619–625, 1997.
79. Gale RE, Fielding AK, Harrison CN, Linch DC. Acquired skewing of X-chromosome inactivation patterns in myeloid cells of the elderly suggests stochastic clonal loss with age. *Br J Haematol* 98:512–519, 1997.
80. Robertson JD, Gale RE, Wynn RF, et al. Dynamics of telomere shortening in neutrophils and T cells during ageing and the relationship to skewed X chromosome inactivation patterns. *Br J Haematol* 109:272–279, 2000.
81. Clemons M, Watson A, Howell A, et al. Macrophage inflammatory protein 1 $\alpha$  attenuates the toxic effects of temozolomide in human bone marrow granulocyte-macrophage colony-forming cells. *Clin Cancer Res* 6:966–970, 2000.

# **New Strategies in Advanced-Stage Hodgkin's Lymphoma: The BEACOPP Regimen**

**Jürgen Wolf, Andrfeas Engert, Jeremy Franklin, Ursula Paulus,  
Volker Diehl, for the German Hodgkin's Lymphoma Study Group**

*Department of Internal Medicine I, University of Cologne, Cologne, Germany*

## **ABSTRACT**

Despite modifications of standard chemotherapy regimens, long-term survival of patients with advanced Hodgkin's lymphoma has remained disappointing, with survival rates of only 50% to 60%. In an attempt to improve the prognosis of these patients, the German Hodgkin's Lymphoma Study Group (GHSg) has developed the BEACOPP (bleomycin, etoposide, doxorubicin, cyclophosphamide, vincristine, procarbazine, and prednisone) regimen in a baseline and a dose-escalated version. The main principles of BEACOPP are (1) increase of total dose, (2) acceleration of administration schedule, and (3) addition of etoposide. Both BEACOPP variants have been compared with the standard regimen COPP (cyclophosphamide, vincristine, procarbazine, and prednisone)/ABVD (doxorubicin, bleomycin, vinblastine, and dacarbazine) in the randomized HD9 trial for advanced Hodgkin's lymphoma. Interim analysis in February 1999 showed significant superiority of the BEACOPP regimen with regard to induction of complete remission, reduction of progressive disease, and freedom from treatment failure. Despite increased transient hematologic toxicity, the regimen is manageable, showing no increase in the rate of toxic deaths during primary chemotherapy.

## **INTRODUCTION**

The treatment of adult Hodgkin's lymphoma is strictly dependent on stage. In early- and intermediate-stage Hodgkin's lymphoma (ie, Ann Arbor stage I/II, without or with clinical risk factors), the strategy of radiotherapy alone or in combination with polychemotherapy has led to excellent long-term survival rates of ~90%. In contrast, only ~60% of patients with advanced-stage Hodgkin's lymphoma (ie, stages IIB with particular risk factors, III, and IV) can be cured. Standard treatment in advanced Hodgkin's lymphoma has been the administration of 6–8 cycles of polychemotherapy (MOPP [mechlorethamine, vincristine, procarbazine, and prednisone], COPP, ABVD). Commonly, radiotherapy is used only as

an adjuvant for initial bulky tumor sites and residual lymphomas after chemotherapy. Several modifications of the standard polychemotherapy regimens have been evaluated, eg, MOPP alternating with ABVD, MOPP/ABV hybrid, and others. None of these modifications, however, has improved survival of patients with advanced-stage Hodgkin's lymphoma.<sup>1-3</sup>

Based on a mathematical model of tumor growth and chemotherapy sensitivity, the GHSG has developed the BEACOPP regimen. The BEACOPP regimen contains the main agents in COPP/ABVD (without vinblastine and dacarbazine) and, as an addition, etoposide. Compared with the BEACOPP baseline regimen, cyclophosphamide, doxorubicin, and etoposide are dose-escalated in the BEACOPP escalated version, with mandatory use of granulocyte colony-stimulating factor (G-CSF). Efficacy and feasibility of BEACOPP in patients with advanced-stage Hodgkin's disease were confirmed in an initial phase 2 study followed by a dose-finding study with G-CSF-supported dose escalation of cyclophosphamide, doxorubicin, and etoposide.<sup>4</sup>

## PATIENTS AND METHODS

In 1993, the GHSG started a randomized trial (HD9) in which the standard treatment (4 cycles of COPP/ABVD, arm A) was compared with baseline BEACOPP (arm B) and escalated BEACOPP (arm C). Radiotherapy was administered to initial bulky sites and residual lymphomas in all 3 arms. The first interim analyses with 321 evaluable patients in September 1996 showed significant inferiority of the COPP/ABVD arm in terms of progression rate and freedom from treatment failure (FFTF), compared with the pooled results of both BEACOPP variants. Accordingly, arm A of the HD9 study had to be closed, and further patients were randomized between arms B and C. When the fourth interim analysis in February 1999 was performed, 1128 patients were randomized in the HD9 trial before November 1, 1997. One thousand seventy patients (94%) were evaluable. The median observation time was 28 months. Two hundred sixty-two patients were randomized in arm A, 405 in arm B, and 403 in arm C. In this analysis, all patients were analyzed in the arm to which they were originally randomized—strictly intent-to-treat. Fourteen arm C patients and 3 arm B patients were switched to COPP/ABVD, and 1 arm A patient was switched to BEACOPP (escalated) due to progression. Only negligible differences were observed in patient characteristics.

## RESULTS

There was significant superiority of the BEACOPP regimen compared with COPP/ABVD in terms of complete remission, progressive disease, and FFTF. Complete remission at the end of the treatment was achieved by 83% of the patients

in arm A, 88% in arm B, and 96% in arm C. In parallel, a significant reduction of the rate of patients with progressive disease could be observed: 12% progressive disease in arm A, 8% in arm B, and 2% in arm C. FFTF at 24 months was 74% in arm A, 81% in arm B, and 90% in arm C. Also, the Hodgkin's-specific FFTF reflected significant superiority of the BEACOPP regimen compared with COPP/ABVD and, in addition, of escalated BEACOPP compared with baseline BEACOPP. Analysis of overall survival (OS) at 24 months yielded OS in arm A, 89%; arm B, 93%; and arm C, 96% (due to the short observation period, no significant differences could be observed).

Despite the higher transient hematologic toxicity of the BEACOPP regimen, there was no increase in the toxic death rate during primary chemotherapy (1.9% arm A, 1.2% arm B, 1.5% arm C). Five cases of leukemia/myelodysplastic syndrome (MDS) (1 MDS, 4 acute myeloid leukemia [AML]) occurred in arm C and 1 (AML) in arm B. Eleven NHL and 4 solid tumors were equally distributed between arms A and B. In arm C, there was 1 NHL and no solid tumors. However, the median observation period is still too short to draw any conclusions on the impact of the new regimen on the induction of secondary neoplasias.

## CONCLUSIONS

With regard to induction of complete remission, reduction of the rate of progressive disease, and freedom from treatment failure, the new BEACOPP regimen for treatment of advanced Hodgkin's lymphoma shows significantly improved efficacy compared with the COPP/ABVD regimen. The regimen is manageable and does not increase the toxic death rate. Although the final analysis of the HD9 study was not performed before 2001, the results obtained so far support the strategy of a moderate dose escalation for the total population of patients with advanced Hodgkin's lymphoma. Thus, the GHSG has replaced COPP/ABVD with BEACOPP as standard treatment for patients with advanced Hodgkin's lymphoma. Questions as to the optimal dose (escalated or baseline) and the role of adjuvant radiotherapy are addressed in the current HD12 trial of the GHSG. In this protocol, 8 cycles of escalated BEACOPP are being compared with 4 cycles of escalated BEACOPP followed by 4 cycles of baseline BEACOPP. A factorial design allows for a comparison of the effect of adjuvant radiotherapy on residual disease and initial tumor bulk.

## REFERENCES

1. DeVita VT, Serpick AA, Carbone PP. Combination chemotherapy in the treatment of advanced Hodgkin's disease. *Ann Intern Med* 73:881–895, 1970.
2. Klimo P, Connors JM. MOPP/ABV hybrid program: combination chemotherapy based



on early induction of seven effective drugs for advanced Hodgkin's disease. *J Clin Oncol* 3:1174-1182, 1985.

3. Canellos GP, Anderson JR, Propert KJ, et al. Chemotherapy of advanced Hodgkin's disease with MOPP, ABVD, or MOPP alternating with ABVD. *N Engl J Med* 327:1478-1484, 1992.
4. Tesch H, Diehl V, Lathan B, et al. Moderate dose escalation for advanced stage Hodgkin's disease using the bleomycin, etoposide, adriamycin, cyclophosphamide, vincristine, procarbazine, and prednisone scheme and adjuvant radiotherapy: a study of the German Hodgkin Lymphoma Study Group. *Blood* 92:4560-4567, 1998.



# **CHAPTER 13**

## **LYMPHOMA**



# **The Role of Autologous Transplantation in the Management of Mantle Cell Lymphoma: A Study From the EBMT**

**E. Vandenberghe, C. Ruiz de Elvira, P. Isaacson, E. Lopez-Guillermo,  
E. Conde, C. Gisselbrecht, F. Guilhot, A. Goldstone, N. Schmitz**

*Royal Hallamshire Hospital (E.V.), Sheffield, UK; EBMT Support Centre (C.R.d.E.), London, UK; UCLH (P.I., A.G.), London, UK; Hospital Clinic (E.L.-G.), Barcelona, Spain; Hospital Universitario (E.C.), Santander; Hôpital Saint-Louis (C.G.), Paris, France; Hôpital la Milétrie (F.G.), Poitiers, France; Christian Albrechts University (N.S.), Kiel, Germany*

## **ABSTRACT**

The curative potential of high-dose chemotherapy (HDC) in mantle cell lymphoma (MCL) is unknown: the European Group for Blood and Marrow Transplantation (EBMT) carried out a retrospective analysis of MCL cases autografted between 1983 and 1998. The cases were reviewed by a national lymphoma panel or specialist hematopathologist. One hundred ninety-three patients from 98 centers were identified; 43 cases were excluded after pathology review ( $n = 14$ ), because slides were unavailable for central review ( $n = 32$ ), or because no details were available from first transplant.

The outcome of 150 patients (112 male and 38 female; mean age at diagnosis, 47 years) was analyzed. Median time to transplant was 416 days (range, 48–2689 days). One hundred sixteen patients (92%) had stage III/IV disease at diagnosis, and 66 (52%) received >1 chemotherapy regimen pre-HDC. Status at transplant was complete remission (CR), 64; partial remission (PR)/chemosensitive disease, 71; and refractory/progressive disease, 15. Total body irradiation (TBI) conditioning was used in 61 patients. Status at 100 days was CR, 96; PR, 23; refractory/progressive disease, 6; death from disease, 2; and toxic death, 6.

The overall and progression-free survival (OS and PFS) rates at 5 years were 48% and 30%, respectively, with no plateau in the curve and a median follow-up of 25 months. OS from diagnosis at 5 years was 61%. Status at transplant was significant for survival ( $P=.0029$ ) by univariate analysis and multivariate analysis ( $P=.001$ ), and 70% of patients transplanted in first CR were alive at 5 years. HDC prolongs survival, but for most patients cure remains elusive in MCL.

## INTRODUCTION

Mantle cell lymphoma was included as a distinct clinicopathological entity in the Revised European American Lymphoma (REAL) classification system described in 1993.<sup>1</sup> Subsequent clinicopathological studies have confirmed the poor prognosis that these predominantly middle-aged to elderly men with stage III/IV disease have, with a median survival of 34–40 months.<sup>2–6</sup> Because of this dismal prognosis, many centers offer high-dose chemotherapy with peripheral stem cell rescue to patients <65 years of age with MCL, despite the lack of randomized trial data showing the efficacy of this approach. Numerous unrandomized small series have been published with conflicting conclusions, possibly because of small numbers or inadequate follow-up.<sup>7–10</sup>

We undertook a retrospective study of all patients who were autografted for MCL between 1988 and 1998 and who were registered with the EBMT, in an attempt to clarify (1) whether HDC conferred a survival advantage to patients with MCL, (2) whether HDC cured patients with MCL, and (3) whether it was possible to identify different prognostic subgroups.

## MATERIALS AND METHODS

A study protocol defining study objectives and a minimum data set was agreed on by a working group from the EBMT.

All patients who were registered with the EBMT and allografted or autografted for MCL between 1988 and 1998 were initially included. Each center with eligible patients was approached for information about diagnostic methodology. Patient material that had been reviewed by a national lymphoma pathology group was included without further review. Centers that did not participate in this form of review and whose center pathologist was not part of a lymphoma review panel were asked to send material for review by an expert hematopathologist (P.I.). If the material was not made available for review, the case was excluded from further study. The patients who were allografted were excluded from this study but will be analyzed later.

The basic data set deemed necessary for inclusion in the study included age at diagnosis and transplant, sex, and updated outcome data. Disease status was defined as CR, no evidence of disease; PR, >50% response to therapy; refractory disease, <50% response to therapy; and progressive disease, disease progression after therapy. If patients had been transplanted more than once, outcome was analyzed from first transplant; however, data were collected on all patients.

Other parameters analyzed included disease stage at diagnosis, nodal disease, measurable disease, bone marrow involvement at transplantation, number of regimens used prechemotherapy, interval from diagnosis to transplantation, disease

status at transplant and 100 days posttransplant, type of conditioning used, use of in vitro purged stem cell/marrow rescue, and cytokines administered posttransplant.

The Kaplan-Meier method was used to calculate OS, PFS, and disease-free survival (DFS). Univariate analysis was done using the log-rank method. Multivariate analysis to study the relevance of individual prognostic factors on OS and PFS used the proportional hazard (Cox regression). Proportionality assumptions were tested using standard methods.

## RESULTS

Two hundred fifteen patients from 98 centers were initially identified, of whom 22 were allografted and were therefore excluded from the current study. A further 45 cases were excluded following pathology review (14 cases), because diagnostic material was not made available for central review (28 cases), or because of inadequate data (3 cases).

The final cohort of 150 patients included 112 male and 38 female patients with a mean age at diagnosis of 47 years. Disease stage at diagnosis was stage I/II ( $n = 10$ ), stage III/IV ( $n = 116$ ), and stage unknown ( $n = 34$ ). Numbers of regimens used before transplantation were 1 ( $n = 50$ ), 2 ( $n = 51$ ), >2 ( $n = 15$ ), and unknown ( $n = 34$ ). The interval from diagnosis to transplantation was 416 days (range, 48–2689 days). Eleven patients had 2 transplants, of which 2 had allografts for the second procedure.

Status at transplant was CR ( $n = 64$ ), PR or sensitive relapse ( $n = 71$ ), and refractory/progressive disease ( $n = 15$ ). Seventy-four patients were conditioned with chemotherapy and 61 with radiotherapy and chemotherapy; in the remaining cases, the conditioning data were unavailable. Mean time to engraftment was 12 days (range, 8–33 days), with 4 engraftment failures. Fifteen patients received in vitro purged marrow/stem cells, and no purging information was available on 27 patients. The outcome at 100 days was CR ( $n = 96$ ), PR ( $n = 23$ ), no change or progressive disease ( $n = 6$ ), death from progressive disease ( $n = 2$ ), toxic death ( $n = 6$ ), and unknown ( $n = 17$ ). The 5-year OS and DFS rates from transplantation were 48% and 30%, respectively (Tables 1 and 2), with no plateau in the curves. The 5-year OS from diagnosis was 61%.

Disease status at transplant was the only significant prognostic factor for OS ( $P = .0029$ ). Disease status and age at transplant (<50 years) were significant by multivariate analysis.

## DISCUSSION

The OS from diagnosis of this group of patients is 61%, with a median follow-up of 25 months, which compares favorably with conventionally treated historical

**Table 1.** Demographic and Clinical Details\*

	<i>n</i>	<i>Unknown</i>
Sex, M/F	112/38	
Median age at diagnosis, y (range)	47 (18–66)	
Stage III/IV at diagnosis	116	34
Number of regimens before HDC		34
1	50	
>1	66	
Median time to HDC, d (range)	416 (48–2689)	
Lymph nodes involved at HDC	23	43
Bone marrow involved at HDC	25	40
Measurable disease at HDC	37	46
TBI conditioning	61	14
In vitro purging	15	27
Cytokines after HDC	47	79
Median time to engraftment, d (range)	12 (4–33)	

\*HDC, high-dose chemotherapy; TBI, total body irradiation.

series. Transplanted patients are highly selected by being young and fit enough to undergo the procedure. Outcome in the EBMT patients is not as good as in the other 2 reported series with follow-up—these have OS and PFS rates of 80% and 58% at 4 and 9 years, respectively.<sup>6,7</sup> Unfortunately, there appears to be no plateau in the survival curve, indicating that the number of patients with MCL cured by high-dose chemotherapy may be small.

The success of HCVAD (cyclophosphamide, vincristine, dexamethasone, adriamycin, high-dose methotrexate, and high-dose Ara-C)—with projected 4-year OS and EFS rates of 90% and 79%, respectively, at a median follow-up of 34 months—suggests that intensifying initial treatment and transplanting in first CR or PR may improve outcome.<sup>11</sup> Data from a recently published article<sup>12</sup> showed

**Table 2.** Disease Status

	<i>Pretransplant</i>	<i>At 100 days</i>
Clinical remission	64	96
Chemosensitive disease	18	NA
Partial remission	53	23
Refractory/progressive disease	15	6
Death from mantle cell lymphoma	NA	2
Toxic death	NA	6
Unknown	NA	17



improved outcome for patients treated with transplant in first CR/PR, compared with later transplantation: OS of 93% vs. 63% at a median of 4 years from diagnosis. The current study confirms that patients transplanted in first remission have a significantly better outcome, with OS of 70% at 5 years. In contrast to the EBMT data, TBI-containing conditioning regimens were associated with improved OS and PFS at 4 years: 89% vs. 60% and 71% vs. 0%, respectively, in 1 study.<sup>7</sup>

Novel strategies such as conventional chemotherapy to maximal response followed by allogeneic transplantation or the use of *in vivo* purging agents such as the anti-CD20 antibody with autologous transplantation are currently being assessed and may improve outcome.

The logistical difficulties of carrying out this sort of retrospective analysis were compounded by our requirement for stringent pathological assessment before inclusion in the study. It is interesting that only 14 cases were excluded on review because of an incorrect diagnosis and that analysis of OS and PFS was not significantly altered by including these cases. It is encouraging that most centers have effective pathology review for patients before proceeding to high-dose chemotherapy. This may allow future retrospective studies to proceed with more confidence without central review. An alternative explanation could be that only centers with specific hematopathology expertise and interest reclassified cases in accordance with REAL criteria, and many transplants for MCL in the registry have therefore not been identified for this study.

## REFERENCES

1. Harris NL, Jaffe ES, Stein H, et al. A revised European-American classification of lymphoid neoplasms: a proposal from the International Lymphoma Study Group. *Blood* 84:361–1392, 1994.
2. Norton AJ, Matthews J, Papa V, et al. Mantle cell lymphoma: natural history defined in a serially biopsied population over a 20 year period. *Ann Oncol* 6:249–256, 1995.
3. Meusers P, Engelhard M, Bartels H, et al. Multicentre randomised therapeutic trial for advanced centrocytic lymphoma: anthracyclines do not improve prognosis. *Haematol Oncol* 7:365–380, 1987.
4. Argatoff L, Connors JM, Klasa RJ, et al. Mantle cell lymphoma: a clinicopathological study of 80 cases. *Blood* 89:2067–2078, 1997.
5. Teodorovic I, Pittaluga S, Kluin-Nelemans JC, et al. Efficacy of 4 different regimens in 64 mantle cell lymphoma cases: clinico-pathological comparison with 498 other non-Hodgkin's lymphoma subtypes. *J Clin Oncol* 13:2819–2826, 1995.
6. Conde E, Bosch F, Arranz R. Autologous stem cell transplantation (ASCT) for mantle cell lymphoma: the experience of the GEL/TAMO Spanish cooperative group. *Bone Marrow Transplant* 23:515, 1999.
7. Milpied N, Gaillard F, Moreau P, et al. High-dose therapy with stem cell transplantation for mantle cell lymphoma: results and prognostic factors, a single center experience. *Bone Marrow Transplant* 22:645–650, 1998.

8. Blay JY, Sebban C, Surbiguet C, et al. High-dose chemotherapy with hematopoietic stem cell transplantation in patients with mantle cell or diffuse centrocytic non-Hodgkin's lymphomas: a single center experience on 18 patients. *Bone Marrow Transplant* 21:51–54, 1998.
9. Kroger N, Hoffknecht M, Dreger P, et al. Long-term disease-free survival of patients with advanced mantle-cell lymphoma following high-dose chemotherapy. *Bone Marrow Transplant* 21:55–57, 1999.
10. Decaudin D, Brousse N, Brice P, et al. Efficacy of autologous transplantation in mantle cell lymphoma: a 3 year follow up study. *Bone Marrow Transplant* 25:251–256, 1999.
11. Khouri I, Romaguera J, Kantarjian H, et al. Update of hyper CVAD followed by stem cell transplantation in mantle cell lymphoma [abstract]. *Blood* 94:2713, 1999.
12. Dreger P, Martin S, Kuse R, et al. The impact of autologous stem cell transplantation on the prognosis of mantle cell lymphoma: a joint analysis of two prospective studies with 46 patients. *Haematol J* 1:1–8, 1999.

# **Involved-Field Radiation Therapy as an Adjunct to the Autotransplant Preparative Regimen for Lymphoma**

**David P. Schenkein, Terry Boyle, Jody Morr, David E. Wazer,  
Julie Morelli, Hillard M. Lazarus, Kenneth B. Miller,  
Edward Stadmauer, Andrew Pecora, Peter Cassileth**

*Department of Radiation Oncology (T.B., J. Morr, D.E.W.) and Division of Hematology-Oncology (D.P.S., J. Morelli, K.B.M.), Tupper Research Institute, New England Medical Center, Tufts University School of Medicine, Boston, Massachusetts; Ireland Cancer Center (H.M.L.), Case Western Reserve University, Cleveland, Ohio; <sup>4</sup>Bone Marrow and Stem Cell Transplant Program (E.S.), University of Pennsylvania Medical Center, Philadelphia, Pennsylvania; Hackensack University Medical Center (A.P.), Hackensack, New Jersey; Sylvester Cancer Center (P.C.), University of Miami, Miami, Florida*

## **INTRODUCTION**

Approximately 45% of adult patients with aggressive non-Hodgkin's lymphoma (NHL) will be cured of their disease with conventional chemotherapy.<sup>1-3</sup> Patients who relapse after multiagent chemotherapy have a particularly poor prognosis.<sup>4</sup> A randomized prospective trial performed by the Parma group<sup>5,6</sup> demonstrated a survival advantage with high-dose chemotherapy and autologous bone marrow transplantation (autoBMT) for patients in sensitive relapse compared with a conventional salvage regimen. Although both arms in the Parma trial received involved-field radiation therapy (IFRT), its importance to the overall treatment remains unclear.<sup>6</sup>

The rationale for the use of IFRT is supported both by the recently completed Eastern Cooperative Oncology Group (ECOG) and Southwest Oncology Group (SWOG) trials<sup>7,8</sup> and by the pattern of relapse observed by other investigators.<sup>4</sup> However, contemporary practice for the use of radiation therapy in combination with high-dose therapy largely reflects institutional preferences. Neither the appropriate fields nor the appropriate sequencing of radiation in conjunction with bone marrow transplantation has been adequately defined.

This study reviews current published data on the role of IFRT as an adjunct to autologous transplantation and reports on the impact and toxicity of IFRT in combination with high-dose sequential (HDS) chemotherapy. Schenkein et al.<sup>2</sup> (and Boyle T, Morr J, Wazer D, et al., unpublished data), have reported on the feasibility and efficacy of this treatment approach in newly diagnosed high-risk patients with NHL.

## PATIENTS AND MATERIALS

### Patient Characteristics

Between October 1993 and October 1996, 31 patients were treated according to a prospective phase 2 protocol at 5 participating centers.<sup>2</sup> HDS chemotherapy consisted of intensive, non-cross-resistant agents delivered in 5 sequential treatment phases, followed by autologous peripheral blood stem cell transplantation (PBSCT) as initially described by Gianni<sup>9</sup> and revised by Schenkein.<sup>2</sup>

IFRT was used in 15 of the 27 patients (56%) following transplantation (Boyle T, Morr J, Wazer D, et al., unpublished data). Radiotherapy was initiated at a median of 61 days (range, 31–136 days) following stem cell infusion. IFRT was delivered to 2 patients achieving complete remission (CR), 10 patients achieving partial remission (PR), and 3 patients with persistent disease. Radiotherapy was delivered to a median of 3 sites (range, 1–6 sites) as defined by the Ann Arbor Staging Manual. Patients received a median of 2400 cGy per site (range, 1980–5400 cGy). Twelve patients did not receive IFRT because of early progressive disease following transplant ( $n = 2$ ), no areas of bulky disease ( $n = 5$ ), early complications ( $n = 2$ ), and unknown reasons ( $n = 3$ ). Toxicity resulting from radiotherapy was determined from medical chart review and graded according to the ECOG system.

## RESULTS

The median follow-up for the cohort was 26 months (range, 2–59 months) after the infusion of stem cells. The overall and relapse-free survival (OS and RFS) rates were 63% and 56%, respectively. OS was 73% and 50% ( $P = .13$ ) with and without the use of IFRT, respectively (Boyle T, Morr J, Wazer D, et al., unpublished data). Relapse occurred in 12 of 27 patients (44%). Two of the patients who suffered late relapses are currently disease-free after undergoing either a second transplant or further multiagent chemotherapy. RFS was 73% for the IFRT group vs. 33% for the group that did not receive IFRT ( $P = .03$ ) at a median follow-up of 26 months.

### Patterns of Failure

Local failure following IFRT occurred in 4 of 15 patients (27%). Failure in the radiation port occurred in all 3 patients considered to have radiographic persistent disease following HDS chemotherapy. The mean radiation dose in the group of patients with in-field failure was 2434 cGy (range, 2400–4580 cGy), and radiotherapy was initiated within an average of 67 days (range, 42–93 days) from PBSC infusion. The mean radiation dose for the patients without evidence of failure was 2929 cGy (range, 2000–5400 cGy), and radiation therapy was initiated

within an average of 58 days (range, 31–105 days) from PBSC infusion. These differences did not reach statistical significance.

### Toxicity

Toxic effects occurred in 10 patients receiving IFRT following HDS chemotherapy and PBSCT (Boyle T, Morr J, Wazer D, et al., unpublished data). Grade III toxicity (hematologic) occurred in 3 patients. These patients required a significant break in the course of their radiation treatments (14–15 days) because of myelosuppression, required transfusions, and hematologic growth factors. There were no grade IV or V toxicities. Esophagitis was the most common form of toxicity recorded; however, all cases were minor grade I symptoms.

### DISCUSSION

The use of IFRT is supported historically by the fact that 70%–80% of patients with stage I NHL who are disease negative, documented by laparotomy, achieve prolonged survival with radiation alone.<sup>10,11</sup> Using 4 cycles of ProMACE-MOPP (cyclophosphamide, etoposide, doxorubicin, nitrogen mustard, procarbazine, vincristine, and high-dose methotrexate) with 4000 cGy IFRT, Longo et al.<sup>10</sup> reported durable remissions in 96% of early-stage intermediate and high-grade NHL. Philip et al.,<sup>4</sup> in their analysis of 100 patients with advanced NHL who failed conventional therapy and then went on to high-dose therapy, reported that 67% of the episodes of progression were isolated and involved initial sites of disease. It was their conclusion that local control remained a major factor. A program of CHOP (cyclophosphamide, doxorubicin, vincristine, and prednisone) for 4 cycles and IFRT to 4000–4400 cGy and 3600 cGy to proximal uninvolved nodal regions<sup>12</sup> yielded a local recurrence rate of 3.3% in 183 patients with early-stage aggressive NHL. The ECOG reported the results of a randomized trial involving 345 patients with intermediate early-stage NHL.<sup>7</sup> In that trial, patients received 8 cycles of CHOP and then were randomized to 3000 cGy to sites of pretreatment involvement vs. no further treatment. At 6 years, improved DFS was reported for the radiation therapy arm, 73% vs. 58% ( $P=.03$ ), and OS was better in the radiation therapy arm, 84% vs. 70% ( $P=.06$ ). Of interest in this trial is that 28% of PRs were converted to CRs with additional radiation therapy. The SWOG<sup>8</sup> completed a similar study but used short-course CHOP plus 4000 cGy vs. CHOP alone. Estimates of survival at 4 years favored the radiation therapy arm, 87% vs. 75% ( $P=.01$ ).

The updated LNH87-2 trial,<sup>13</sup> which compared sequential chemotherapy versus autologous transplantation as consolidation for NHL patients in first complete remission, reported superior DFS (59% vs. 39%) and OS (65% vs. 52%) for 236 high-risk patients. Haioun et al.<sup>13</sup> did not report radiation as part of either the

preparative or consolidative phase of treatment. The Parma data<sup>5</sup> demonstrated a 53% OS at 5 years with autologous transplantation for patients with chemotherapy-sensitive NHL in relapse. Forty-five percent of the patients received 130 cGy bid to a total dose of 2600 cGy to areas of bulky disease as part of the preparative regimen. There was a nonsignificant RFS advantage for the group receiving radiation therapy, compared with the group that did not receive radiation therapy, 64% vs. 45%, respectively.

Numerous authors have observed that transplant failures result from progressive lymphoma rather than toxicity. Phillips et al.<sup>14</sup> reported on a group of 68 patients with relapsed NHL treated with intensive chemotherapy, TBI, and autologous marrow transplantation. In their study, when disease could be covered with a conventional radiation port, it was treated with 2000 cGy IFRT. They reported a trend toward improved survival with the use of IFRT ( $P=.07$ ) before transplant.<sup>14</sup> Mundt et al.<sup>15</sup> reported on the use of IFRT in a group of 53 patients with aggressive NHL treated with high-dose chemotherapy and PBSCT. They reported a 61% local control rate for sites amenable to a radiation port but not irradiated. Local control for sites failing to achieve a CR was 29%; of note, adjuvant IFRT improved the local control to 100% ( $P=.05$ ). A 2-year event-free survival of 70%, reflecting the use of IFRT posttransplant, was reported by Brasacchio et al.<sup>16</sup> vs. 35% without IFRT. Advantages of IFRT for progressive Hodgkin's disease have been reported by several authors.<sup>17-20</sup> Phillips et al.<sup>17</sup> reported a trend toward increased OS ( $P=.09$ ) with the use of IFRT. Mundt et al.<sup>18</sup> noted that patients with refractory Hodgkin's disease with persistent disease posttransplant had a better RFS of 40% vs. 12% ( $P=.04$ ) with the use of IFRT. Similar observations have been made by Horning et al.,<sup>19</sup> who reported an improved 3-year RFS of 100% vs. 60% ( $P=.04$ ) with the use of IFRT posttransplant. Pezner et al.<sup>20</sup> described a 7% in-field failure rate posttransplant for sites treated with IFRT.

The issue of dose is more complex, however. Mauch<sup>21</sup> currently recommends 4000 cGy for patients with diffuse large cell lymphoma who achieve a CR to multiagent chemotherapy. In the present study (Boyle T, Morr J, Wazer D, et al., unpublished data), there was a 27% in-field failure rate at a dose of 2400 cGy. The mean radiation dose for patients without failure in the radiation portal was higher, 2935 cGy vs. 2455 cGy.

Several studies have documented the higher toxicity of IFRT when used before radiotherapy, particularly in patients receiving thoracic radiation.<sup>22</sup> In addition, the use of radiotherapy within the preparative regimen has the potential to increase the risk of secondary malignancies, in particular, MDS and acute leukemia.<sup>23</sup>

Vose et al.<sup>24</sup> have recently analyzed data from the Autologous Blood and Marrow Transplant Registry (ABMTR) on the use of autologous transplantation for 184 patients with aggressive NHL that had never achieved a remission to standard chemotherapy. In multivariate analysis, not receiving posttransplant IFRT

was an adverse prognostic factor ( $P=.05$ ). Other adverse factors included chemotherapy resistance, receiving  $>3$  prior chemotherapy regimens, Karnofsky score  $<80\%$  at transplant, and age  $>55$  years. In contrast, registry data from the ABMTR have failed to demonstrate an advantage for IFRT with transplant in patients in first relapse or second complete remission (Lazarus, HM, personal communication).

Overall, the data from nonrandomized clinical trials suggest that IFRT posttransplant is well tolerated and likely decreases field relapses at sites of prior disease. However, randomized prospective clinical trials will be needed to fully answer this question.

## REFERENCES

1. Shipp MA, Klatt MM, Yeap B, et al. Patterns of relapse in large cell lymphoma patients with bulk disease: implications for the use of adjuvant radiation therapy. *J Clin Oncol* 7:613–618, 1989.
2. Schenkein D, Roitman D, Miller K, et al. A phase II multicenter trial of high-dose sequential chemotherapy and peripheral blood stem cell transplantation as initial therapy for patients with high-risk non-Hodgkin's lymphoma. *Biol Blood Marrow Transplant* 3:210–216, 1997.
3. Fisher R, Gaynor E, Dahlberg S, et al. Comparison of a standard regimen (CHOP) with three intensive chemotherapy regimens for advanced non-Hodgkin's lymphoma. *N Engl J Med* 328:1002–1006, 1993.
4. Philip T, Armitage JO, Spitzer G, et al. High-dose therapy and autologous bone marrow transplantation after failure of conventional chemotherapy in adults with intermediate-grade or high-grade non-Hodgkin's lymphoma. *N Engl J Med* 316:1493–1498, 1987.
5. Philip T, Guglielmi C, Hagenbeek A, et al. Autologous bone marrow transplantation as compared with salvage chemotherapy in relapses of chemotherapy-sensitive non-Hodgkin's lymphoma. *N Engl J Med* 333:1540–1545, 1995.
6. Philip T, Chauvin F, Armitage J, et al. Parma International Protocol: pilot study of DHAP followed by involved-field radiotherapy and BEAC with autologous bone marrow transplantation. *Blood* 77:1587–1592, 1991.
7. Glick JH, Kim K, Earle J, et al. An ECOG randomized phase III trial of CHOP vs. CHOP + radiotherapy (XRT) for intermediate grade early stage non-Hodgkin's lymphoma (NHL) [abstract]. *Proc ASCO* 14:391, 1995. Abstract 1221.
8. Miller TP, Dahlberg S, Cassady JR, et al. Chemotherapy alone compared with chemotherapy plus radiotherapy for localized intermediate- and high-grade non-Hodgkin's lymphoma. *N Engl J Med* 339:21–26, 1998.
9. Gianni A, Bregni M, Siena S, et al. High-dose chemotherapy and autologous bone marrow transplantation compared with MACOP-B in aggressive B-cell lymphoma. *N Engl J Med* 336:1290–1297, 1997.
10. Longo D, Glatstein E, Duffey P, et al. Treatment of localized aggressive lymphomas with combination chemotherapy followed by involved-field radiation therapy. *J Clin Oncol* 7:1295–1302, 1989.

11. Connors J, Klimo P, Fairey R, et al. Brief chemotherapy and involved field radiation for limited-stage histologically aggressive lymphoma. *Ann Intern Med* 107:25–29, 1987.
12. Tondini C, Zanini M, Lombardi F, et al. Combined modality treatment with primary CHOP chemotherapy followed by locoregional irradiation in stage I or II histologically aggressive non-Hodgkin's lymphoma. *J Clin Oncol* 11:720–725, 1993.
13. Haioun C, Lepage E, Gisselbrecht C, et al. Benefit of autologous bone marrow transplantation over sequential chemotherapy in poor-risk aggressive non-Hodgkin's lymphoma: updated results of the prospective study LNH87–2. *J Clin Oncol* 15:1131–1137, 1997.
14. Phillips G, Fay J, Herzig R, et al. The treatment of progressive non-Hodgkin's lymphoma with intensive chemoradiotherapy and autologous marrow transplantation. *Blood* 75: 831–838, 1990.
15. Mundt AJ, Williams SF, Hallahan D. High dose chemotherapy and stem cell rescue for aggressive non-Hodgkin's lymphoma: pattern of failure and implications for involved-field radiotherapy. *Int J Radiat Oncol Biol Phys* 39:617–625, 1997.
16. Brasacchio R, Constine L, Rapoport A, et al. Dose escalation of consolidation radiation therapy (involved field) following autologous bone marrow transplant for recurrent Hodgkin's disease and lymphoma [abstract]. *Proc 38th ASTRO* 171, 1997. Abstract 25.
17. Phillips G, Wolff R, Herzig H, et al. Treatment of progressive Hodgkin's disease with intensive chemoradiotherapy and autologous bone marrow transplantation. *Blood* 73:2086–2092, 1989.
18. Mundt AJ, Sibley G, William S, et al. Patterns of failure following high-dose chemotherapy and autologous bone marrow transplantation with involved field radiotherapy for relapsed/refractory Hodgkin's disease. *Int J Radiat Oncol Biol Phys* 33:261–270, 1995.
19. Poen JC, Hoppe RT, Horning SJ. High-dose therapy and autologous bone marrow transplantation for relapsed/refractory Hodgkin's disease: the impact of involved field radiotherapy on patterns of failure and survival. *Int J Radiat Oncol Biol Phys* 36:3–12, 1996.
20. Pezner RD, Nademanee A, Niland JC, et al. Involved field radiation therapy for Hodgkin's disease autologous bone marrow transplantation regimens. *Radiother Oncol* 34:23–29, 1995.
21. Shafman T, Mauch P. The large cell lymphomas. *Semin Radiat Oncol* 5:267–280, 1995.
22. Tsang RW, Gospodarowicz MK, Sutcliffe SB, Crump M, Keating A. Thoracic radiation therapy before autologous bone marrow transplantation is relapsed or refractory Hodgkin's disease. *Eur J Cancer* 35:73–78, 1999.
23. Armitage JO. Myelodysplasia and acute leukemia after autologous bone marrow transplantation. *J Clin Oncol* 18:945–946, 2000.
24. Vose JM, Zhang MJ, Rowlings PA. Autologous transplantation for diffuse aggressive non-Hodgkin's lymphoma in patients never achieving remission: a report from the Autologous Blood and Marrow Transplant Registry. *J Clin Oncol* 19:406–413, 2001.



# CD34<sup>+</sup>-Enriched Peripheral Blood Progenitor Cell Collections in Lymphoma Autotransplants Are Associated With Increased Morbidity

Hillard M. Lazarus, Judah Friedman, Omer N. Koç

*The Ireland Cancer Center and Department of Medicine, University Hospitals of Cleveland, Case Western Reserve University, Cleveland, Ohio*

## ABSTRACT

**Background.** CD34<sup>+</sup> enrichment of peripheral blood progenitor cells (PBPCs) may reduce tumor burden but could compromise immunologic reconstitution and increase infectious risk in the autologous PBPC transplant patient.

**Design.** We compared infectious complications in lymphoma autotransplant patients treated with a single high-dose chemotherapy regimen and supported either with CD34<sup>+</sup>-enriched PBPCs ( $n = 19$ ) or unmanipulated PBPCs ( $n = 24$ ). Analysis was limited to patients followed for a minimum of 1 year after discharge from initial hospitalization and free of lymphoma recurrence.

**Results.** We observed a statistically significant increase in the number of patients with 1 or more infectious events in the CD34<sup>+</sup>-enriched group (14 of 19) compared with the unmanipulated PBPCs group (9 of 24,  $P < .01$ ). Greater numbers of patients with 2 or more infectious events were observed in the CD34<sup>+</sup>-enriched population (7 of 19 vs. 2 of 24,  $P < .03$ ) as well as an increased incidence of bacterial infections (10 of 19 vs. 5 of 24,  $P < .05$ ). Two deaths due to infectious complications were observed in the CD34<sup>+</sup>-enriched subjects. There was no significant difference in blood lymphocyte or monocyte recovery between groups.

**Conclusions.** Lymphoma patients undergoing autotransplant using CD34<sup>+</sup>-enriched rather than unmanipulated PBPC collections have a significant increase in long-term incidence of infectious events. Patients who undergo CD34<sup>+</sup> selection of PBPC transplantation should be followed closely for infectious complications, and prolonged infectious prophylaxis should be considered.

## INTRODUCTION

High-dose chemotherapy followed by autologous peripheral blood progenitor cell transplantation can provide prolonged disease-free survival for refractory and

relapsed Hodgkin's disease and non-Hodgkin's lymphoma patients.<sup>1-7</sup> A number of investigators have provided evidence in leukemia, lymphoma, breast cancer, and neuroblastoma that contaminating tumor cells in the harvested PBPC collections may be responsible for relapse after transplantation.<sup>8-17</sup> Positive selection of PBPC collections for CD34<sup>+</sup> progenitors may reduce the number of contaminating tumor cells while preserving hematopoietic engraftment.<sup>18-20</sup> Along with reducing tumor burden, the CD34<sup>+</sup> cell enrichment procedure may also compromise immunologic reconstitution by depleting the grafts of mature T and B lymphocytes<sup>20-22</sup>; an increase in the number of opportunistic infections may result. Severe viral infections, including cytomegalovirus (CMV) retinitis, adenovirus-associated hemorrhagic cystitis, fatal herpes pneumonitis, and severe cryptosporidiosis, have been reported after autologous CD34<sup>+</sup>-enriched PBPC transplants.<sup>21,22</sup> One study found a higher frequency of CMV disease in patients transplanted with the CD34<sup>+</sup>-enriched PBPCs compared with patients transplanted with unselected PBPCs.<sup>23</sup> We therefore compared infectious morbidity associated with CD34<sup>+</sup>-enriched PBPC transplantation in lymphoma patients with that in patients treated with an identical high-dose chemotherapy regimen but who received unmanipulated PBPCs. In this single-institution study, we determined that patients supported with autologous CD34<sup>+</sup>-enriched PBPCs had a higher 1-year infectious morbidity after transplantation.

## PATIENTS AND METHODS

We reviewed the records of all lymphoma patients undergoing autologous PBPC transplantation at the Ireland Cancer Center, University Hospitals of Cleveland, Case Western Reserve University. Patients with relapsed, primary refractory (induction failure), or high-risk non-Hodgkin's lymphoma or Hodgkin's disease were treated with high-dose carmustine (BCNU), etoposide, and cisplatin<sup>7</sup> and were supported using either CD34<sup>+</sup>-enriched autologous PBPCs (1996-1998) or unmanipulated autologous PBPCs (1993-1998). A total of 19 CD34<sup>+</sup>-enriched and 24 unmanipulated PBPC transplant patients who had a minimum of 1 year of follow-up and were free of malignant disease recurrence were included in this analysis. All patients achieved myeloid engraftment before discharge from the hospital.<sup>19,24</sup> The total leukocyte, absolute lymphocyte, and monocyte counts were recorded from patient charts at approximate intervals of 3 weeks, 6 weeks, 6 months, and 1 year after autotransplant. The records were reviewed for complications after transplant, commencing at discharge from the initial hospitalization and limited to 1 year after transplantation. Complications incurred during the inpatient autotransplant hospitalization are not part of this report. The demographic and clinical characteristics of the study patients are included in Table 1.

## Eligibility for Autotransplant

Patients were required to have an Eastern Cooperative Oncology Group performance status of 0 or 1 and have adequate visceral organ function, including left ventricular ejection fraction at least 45% of predicted, no uncontrolled congestive heart failure or hypertension, no myocardial infarction in the previous 6 months, 1-second forced expiratory volume and pulmonary carbon monoxide diffusing capacity >50% of predicted, actual or calculated creatinine clearance >60 mL/min, alanine transaminase and aspartate transaminase <3 times normal, and no active infections or severe endocrine or neurologic disorders. Patients were excluded if they had cumulative exposure to BCNU >200 mg/m<sup>2</sup>, cumulative exposure to bleomycin >100 U/m<sup>2</sup>, cumulative exposure to doxorubicin >550 mg/mg<sup>2</sup>, evidence of active infection, or a history of another malignant disease within the past 5 years. Patients were not excluded for evidence of tumor on routine histologic staining of bilateral paraffin-embedded posterior iliac crest bone marrow biopsies.

## Mobilization and Collection of PBPCs

The PBPC mobilization regimen consisted of cyclophosphamide 4.0 g/m<sup>2</sup> intravenously over 3–6 hours on the first day of mobilization; mesna 3.0 g/m<sup>2</sup> was contained within the cyclophosphamide dosing bag, followed by 500 mg every 3 hours by mouth or by vein for 8 doses.<sup>19,24</sup> Prednisone 2 mg/kg per day was given orally for the first 4 days of mobilization. Granulocyte colony-stimulating factor (Amgen, Thousand Oaks, CA) 10 µg/kg per day was given subcutaneously beginning between 36 and 48 hours after the completion of cyclophosphamide until combined PBPC collections provided at least  $2.0 \times 10^6$  CD34<sup>+</sup> cells/kg patient weight.

## Positive Selection of CD34<sup>+</sup> Cells From Mobilized PBPCs

Mononuclear cells from each leukapheresis collection were prepared and passed over the immunoaffinity column device (Ceprate, SC System) as directed by the manufacturer (CellPro, Bothell, WA).<sup>19,24</sup> Absorbed CD34<sup>+</sup> cells were resuspended at  $2 \times 10^7$  cells/mL and frozen using a controlled-rate liquid nitrogen freezer in the presence of 7.5% (final concentration) dimethylsulfoxide (Sigma, St. Louis, MO).<sup>19,24</sup>

## Evaluation

This study included only patients who were followed frequently at the Ireland Cancer Center, ie, who returned for follow-up approximately every 2 months. Patients were given antimicrobial prophylaxis with trimethoprim-sulfamethoxazole

for up to 3–4 months after discharge from the initial transplant hospitalization. Acyclovir and ciprofloxacin were not given routinely as prophylaxis. Furthermore, vaccination with pneumococcus and Hemophilus influenza b vaccines and diphtheria/tetanus toxoid was not begun until 1 year after transplant.

Complications and infections occurring during the initial hospitalization while patients were neutropenic are not reported herein. Patients lacking documentation of follow-up visits and those with documented disease relapse in the year after transplantation also were excluded from analysis, as were patients who received rituximab (Genentech, South San Francisco, CA), anti-B-cell monoclonal antibody therapy. Bacterial, viral, and fungal infections were defined either by clinical symptoms and response to treatment or by confirmation with laboratory culture. Infections leading to sepsis and multiorgan failure, adult respiratory distress syndrome (ARDS), and death were considered as one infectious event. Infections occurring in different anatomical sites concurrently were recorded as separate infections. Presumed infectious complications that had an unproven or unknown etiology were included in a “presumed infectious complications” category. Such events included upper respiratory infections, flu-like illnesses, and unexplained fevers unrelated to malignancy.

### **Statistical Methods**

The Fisher exact test was used to compare the frequency of infectious and noninfectious complications between the CD34<sup>+</sup>-enriched transplant patients and the unmanipulated PBPC transplant patients.

## **RESULTS**

### **Demographics**

Study patients' clinical characteristics are summarized in Table 1. Median age at transplant was similar in the 2 groups, as was the number of prior chemotherapy regimens. Patients transplanted using unmanipulated PBPCs included a greater number of women, and more patients had received localized radiation therapy, either in conjunction with transplant or earlier in the treatment course.

### **Infectious Complications**

The CD34<sup>+</sup>-enriched population had a significantly increased number of patients with 1 or more infectious events compared with the unmanipulated PBPCs group (14 of 19 vs. 9 of 24,  $P < .01$ ) (Table 2). Additionally, there were increased numbers of patients with 2 or more infectious events in the CD34<sup>+</sup>-enriched group

**Table 1.** Characteristics of Lymphoma Patients Undergoing Autotransplants\*

	<i>CD34<sup>+</sup>-Enriched PBPCs</i>	<i>Unmanipulated PBPCs</i>
Patients	19	24
Age, y	39 (22–58)	44 (22–59)
Sex, M/F	9/10	15/9
Diagnosis		
Hodgkin's disease	7	6
Non-Hodgkin's lymphoma	12	18
Number of prior chemotherapy regimens	2 (1–3)	2 (1–4)
Prior radiation†	7 (37)	13 (54)

\*Data are *n*, median (range), or *n* (%). PBPC, peripheral blood progenitor cell. †Includes any previous exposure to local radiation therapy, either in conjunction with transplantation or earlier in the treatment course.

(7 of 19 vs. 2 of 24,  $P < .03$ ). This difference reflected an increased incidence of bacterial infections observed in the CD34<sup>+</sup>-enriched group (10 of 19 in the CD34<sup>+</sup>-enriched group vs. 5 of 24 in the unmanipulated PBPCs group,  $P < .05$ ). The greater numbers of viral infections and the presumed infections found in the CD34<sup>+</sup>-enriched group was not significantly different from those in the unmanipulated PBPCs group. Only 1 fungal infection (hepatosplenic candidiasis) was noted; it occurred in the unmanipulated PBPC transplant population. A detailed documentation of the infectious complications in individual patients, including the type and timing of bacterial, viral, and fungal infections, appears in Table 3. Infectious events occurred at a median of 4 months in the CD34<sup>+</sup>-enriched patients and

**Table 2.** Comparison of Infectious Complications Within 1–12 Months in Patients Given Unmanipulated vs. CD34<sup>+</sup>-Enriched Peripheral Blood Progenitor Cells

<i>Complication</i>	<i>Unmanipulated</i>	<i>CD34<sup>+</sup>-Enriched</i>	<i>P*</i>
<i>n</i>	24	19	—
No infections	15	5	.01†
>1 infectious complication	9	14	—
>2 infectious complications	2	7	—
One or more bacterial infections	5	10	.05
One or more viral infections	2	5	.21
One or more fungal infections	1	0	NS
One or more presumed infections	3	5	NS
Infectious deaths	0	2	NS

\*Fisher exact test; †ordered columns, 2×3 table.

**Table 3.** Infectious Complications and Time to Occurrence After Transplant in Patients Receiving CD34<sup>+</sup>-Enriched and Unmanipulated PBPC Collections\*

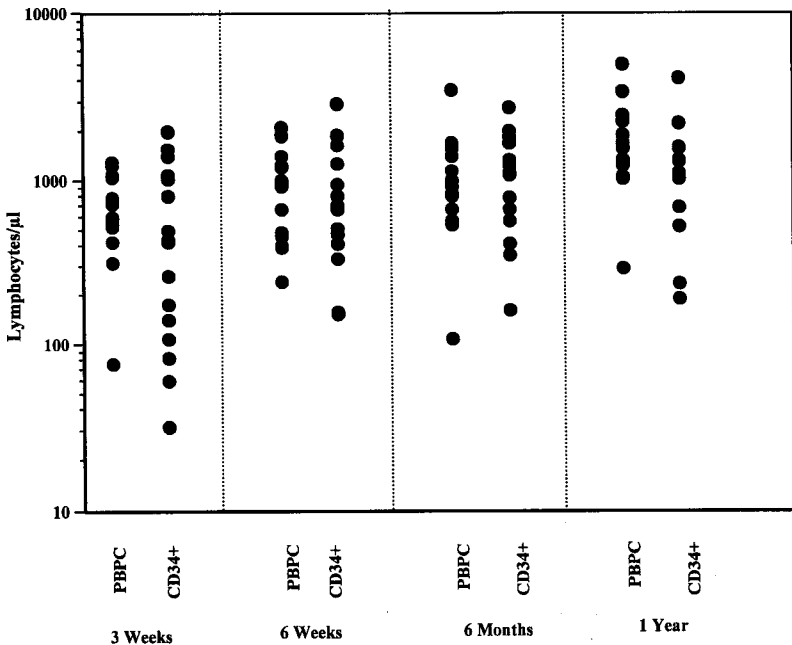
<i>Patient</i>	<i>Infectious Complication</i>
CD34 <sup>+</sup> -enriched PBPCs	
1	Flu-like illness, 1 mo
2	Sinusitis/mastoiditis, 7 mo
3	Sinusitis, 3 mo and 10 mo
4	URI, 1 mo and 9 mo
5	<i>Streptococcal sp</i> pharyngitis, 11 mo
6	<i>S. aureus</i> sepsis, 1 mo Flu-like illness, 12 mo
7	pericolonic <i>Pseudomonas sp</i> abscess, 1 mo
8	Sinusitis, 1 mo
9	Flu-like illness and Guillain-Barré syndrome, 5 mo Sepsis, ARDS, death, 5 mo
10	Varicella zoster, 4 mo Viral thyroiditis, 4 mo Perianal HSV-II, 4 mo Pneumonia, 7 mo
11	Bronchitis ( <i>Pseudomonas sp</i> ), 1 mo UTI, 2 mo and 3 mo Pneumonia, ARDS, death, 4 mo
12	FUO, 1 mo
13	URI, 2 mo and 7 mo Pneumonia, 4 mo Varicella zoster, 7 mo
14	Varicella zoster, 10 mo
Unmanipulated PBPCs	
1	FUO, 3 mo Hepatosplenic candidiasis, 5 mo Varicella zoster, 11 mo
2	Sinusitis, 12 mo
3	Polymicrobial sepsis, 1 mo
4	Vestibulitis, 1 mo
5	Varicella zoster, 4 mo
6	Varicella zoster, 5 mo
7	Bacterial conjunctivitis, 5 mo URI, 5 mo
8	Flu-like illness, 1 mo
9	Sinusitis, 10 mo

\*ARDS, adult respiratory distress syndrome; FUO, fever of unknown origin; HSV, herpes-simplex virus; URI, upper respiratory infection; UTI, urinary tract infection.

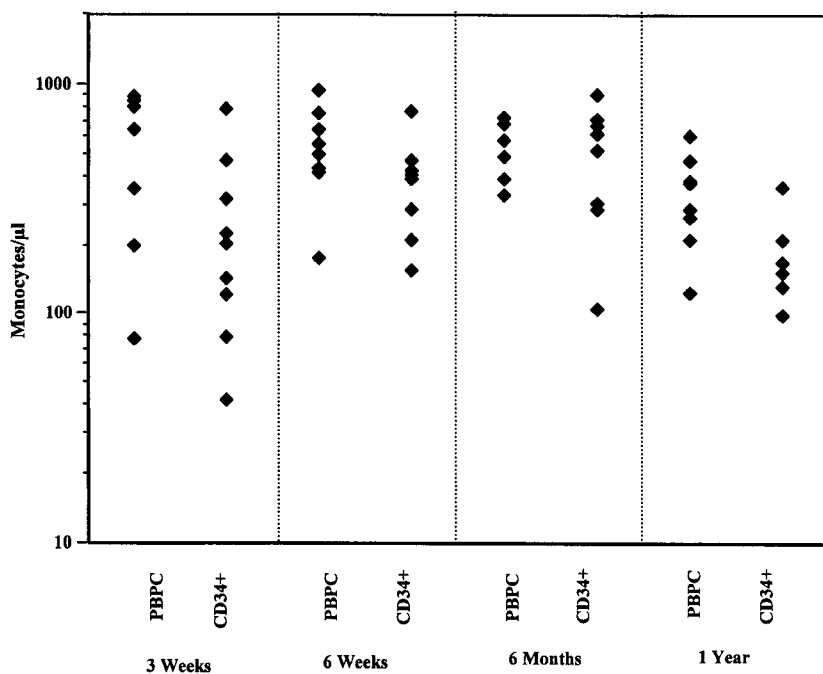
5 months in the unmanipulated PBPC recipients. Sixty-nine percent of the infections in the CD34<sup>+</sup>-selected patients occurred before 6 months, and 75% in the unmanipulated PBPC transplant patients. There were 2 infectious deaths in the CD34<sup>+</sup>-selected group and none in the unmanipulated PBPC patients. This low event rate precludes a statistically significant conclusion; infectious deaths in lymphoma patients undergoing autologous PBPC transplantation, however, is uncommon at our center and thus has clinical significance.

### Lymphocyte and Monocyte Counts

Peripheral blood lymphocyte and monocyte counts at 3 weeks, 6 weeks, 6 months, and 1 year after transplant are shown in Figures 1 and 2. There was no significant difference in mean lymphocyte and monocyte counts between study groups during the 12-month posttransplant follow-up period. There appeared to be a greater variability in blood lymphocyte and monocyte counts obtained from patients transplanted using CD34<sup>+</sup>-enriched cells.



**Figure 1.** Peripheral blood lymphocyte counts obtained from patients undergoing autotransplant using autologous unmanipulated peripheral blood progenitor cells (PBPC) or CD34<sup>+</sup>-enriched PBPCs. Scattergram of lymphocyte counts after transplant at indicated time points.



**Figure 2.** Peripheral blood monocyte counts obtained from patients undergoing auto-transplant using autologous unmodified peripheral blood progenitor cells (PBPC) or CD34<sup>+</sup>-enriched PBPC. Scattergram of monocyte counts after transplant at indicated time points.

## DISCUSSION

We report a significant increase in the incidence of 1 or more late infectious complications in lymphoma patients transplanted using autologous CD34<sup>+</sup>-enriched PBPCs compared with unmanipulated PBPCs within the first year after transplantation. The two patient groups had comparable demographics, and both populations were monitored frequently after autograft. Interestingly, there was an increased incidence of bacterial infections but neither fungal nor viral infections in the CD34<sup>+</sup>-enriched patients. This finding may be due to a low detection rate of viral infections, because viral cultures are not routinely performed in these patients. Only 1 documented fungal infection occurred in the entire study population, and the low event rate precludes meaningful comparison between cohorts for fungal infections.

The increased morbidity in the CD34<sup>+</sup>-enriched transplant patients may be attributed to either qualitative or quantitative differences in the reconstituted immune systems of the patients. The absolute lymphocyte and monocyte counts do not appear to differ between groups, and it is more likely that qualitative and



quantitative differences in CD4<sup>+</sup> or CD8<sup>+</sup> lymphocyte subsets may be responsible for the increased infection rate in this group. Others investigating the lymphoid reconstitution of patients given CD34<sup>+</sup>-selected PBPC collections found fewer circulating B-cells and CD4<sup>+</sup> T-cells after autotransplant compared with subjects who received unmanipulated PBPC grafts.<sup>25</sup> According to reverse transcription–polymerase chain reaction amplification of the T-cell receptor antigen binding region (VDJ regions), T cells in the CD34<sup>+</sup>-enriched transplant patients had decreased diversity of VDJ regions compared with those in the unmanipulated PBPC transplant group. These studies suggest that the CD34<sup>+</sup> enrichment process may result in both quantitative and qualitative deficiencies in a reconstituted immune system compared with the immune system of patients reconstituted with the unmodified PBPC graft. A lower CD4<sup>+</sup>/CD8<sup>+</sup> ratio and/or fewer B lymphocytes could result in a clinically significant defect in immunity of the patients transplanted with CD34<sup>+</sup>-enriched cells. Two studies found that chemotherapy exposure alters blood lymphocyte subsets, ie, PBPC collections obtained from patients have a decreased CD4<sup>+</sup>/CD8<sup>+</sup> ratio compared with the peripheral blood of normal volunteers.<sup>26,27</sup> Furthermore, the autotransplant patients had increased suppressor T-cell activity.<sup>22</sup> The use of an additional step in the processing of PBPCs for transplantation, such as the CD34<sup>+</sup> enrichment process, may further alter the lymphoid reconstitution of autologous PBPC recipients.

We did not focus on infectious events that occurred during the initial hospitalization but chose to address those episodes that occurred during posttransplant months 1–12. Patients transplanted with CD34<sup>+</sup>-enriched cells may require increased infectious prophylaxis and closer monitoring than patients receiving unmanipulated PBPC grafts. To address the mechanism responsible for our observation, it may be necessary to prospectively examine B-cell and CD4<sup>+</sup>CD8<sup>+</sup> T-lymphocyte engraftment and function after autotransplant. The problem of an increased infectious diathesis may be magnified with the increased use of the newly developed anti-B-cell or anti-T-cell targeted therapies designed to decrease tumor recurrence. Such agents may further decrease tumor burden, but also could delay immune reconstitution and increase infections when used in the autotransplant setting.

## ACKNOWLEDGMENTS

This work was supported, in part, by Public Health Service Grant P30CA43703.

## REFERENCES

1. Armitage JO. Bone marrow transplantation. *N Engl J Med* 330:827–838, 1994.
2. Pettengell R, Radford JA, Morgenstern GR, et al. Survival benefit from high-dose therapy with autologous blood progenitor-cell transplantation in poor-prognosis non-

- Hodgkin's lymphoma. *J Clin Oncol* 14:586–592, 1996.
3. Lazarus HM, Rowlings PA, Zhang M-J, et al. Autotransplants for Hodgkin disease in patients never achieving remission: a report from the Autologous Blood and Marrow Transplant Registry (ABMTR). *J Clin Oncol* 17:534–545, 1999.
  4. Linch DC, Winfield D, Goldstone AH, et al. Dose intensification with autologous bone-marrow transplantation in relapsed and resistant Hodgkin's disease: results of a BNLI randomised trial. *Lancet* 341:1051–1054, 1993.
  5. Haioun C, Lepage E, Gisselbrecht C, et al. Benefit of autologous bone marrow transplantation over sequential chemotherapy in poor-risk aggressive non-Hodgkin's lymphoma: updated results of the prospective study LNH87–2. *J Clin Oncol* 15:1131–1137, 1997.
  6. Philip T, Guglielmi C, Hagenbeek A, et al. Autologous bone marrow transplantation as compared with salvage chemotherapy in relapses of chemotherapy-sensitive non-Hodgkin's lymphoma. *N Engl J Med* 333:1540–1545, 1995.
  7. Lazarus HM, Crilly P, Ciobanu N, et al. High-dose carmustine, etoposide, and cisplatin and autologous bone marrow transplantation for relapsed and refractory lymphoma. *J Clin Oncol* 10:1682–1689, 1992.
  8. Sharp JG, Kessinger A, Mann S, et al. Outcome of high-dose therapy and autologous transplantation in non-Hodgkin's lymphoma based on the presence of tumor in the marrow or infused hematopoietic harvest. *J Clin Oncol* 14:214–219, 1996.
  9. Brenner MK, Rill DR, Moen RC, et al. Gene-marking to trace origin of relapse after autologous bone-marrow transplantation. *Lancet* 341:85–86, 1993.
  10. Grande M, Barbu V, Van den Akker J, et al. Autologous bone marrow transplantation in ALL: relapse linked to infusion of tumor cells with the back-up marrow. *Bone Marrow Transplant* 14:477–480, 1994.
  11. Deisseroth A, Zu Z, Claxton D, et al. Genetic marking shows that Ph<sup>+</sup> cells present in autologous transplants of chronic myelogenous leukemia (CML) contribute to relapse after autologous bone marrow in CML. *Blood* 83:3068–3076, 1994.
  12. Vredenburgh JJ, Silva O, Broadwater G, et al. The significance of tumor contamination in the bone marrow from high-risk primary breast cancer patients treated with high-dose chemotherapy and hematopoietic support. *Biol Blood Marrow Transplant* 3:91–97, 1997.
  13. Rill DR, Santana VM, Roberts WM, et al. Direct demonstration that autologous bone marrow transplantation for solid tumors can return a multiplicity of tumorigenic cells. *Blood* 84:380–383, 1994.
  14. Bertolini F, Lanza A, Peccatori F, et al. Hematopoietic progenitor cell collection and neoplastic cell contamination in breast cancer patients receiving chemotherapy plus granulocyte colony-stimulating factor (G-CSF) or G-CSF alone for mobilization. *Ann Oncol* 9:913–916, 1998.
  15. Mori M, Mimori K, Inoue H, et al. Detection of cancer micrometastases lymph nodes by reverse transcriptase polymerase chain reaction. *Cancer Res* 55:3417–3420, 1995.
  16. Schulze R, Schulze M, Wischnik A, et al. Tumor cell contamination of peripheral blood stem cell transplant and bone marrow in high-risk breast cancer patients. *Bone Marrow Transplant* 19:1223–1228, 1997.
  17. Pedrazzoli P, Battaglia M, Da Prada GA, et al. Role of tumor cells contaminating the graft

- in breast cancer recurrence after high dose chemotherapy. *Bone Marrow Transplant* 20:167–169, 1997.
18. Schiller G, Vescio R, Freytes C, et al. Transplantation of CD34<sup>+</sup> peripheral blood progenitor cells after high dose chemotherapy for patients with advanced multiple myeloma. *Blood* 86:390–397, 1995.
  19. Koc ON, Gerson SL, Phillips GL, et al. Autologous CD34<sup>+</sup> cell transplantation for patients with advanced lymphoma: effects of overnight storage on peripheral blood progenitor cell enrichment and engraftment. *Bone Marrow Transplant* 21:337–343, 1998.
  20. Nachbaur D, Fink F-M, Nussbaumer W, et al. CD34<sup>+</sup>-selected autologous peripheral blood stem cell transplantation (PBSCT) in patients with poor-risk hematologic malignancies and solid tumors: a single-centre experience. *Bone Marrow Transplant* 20:827–834, 1997.
  21. Miyamoto T, Gondo H, Miyoshi Y. Early viral complications following CD34-selected autologous peripheral blood stem cell transplantation for non-Hodgkin's lymphoma. *Br J Haematol* 100:348–350, 1998.
  22. Nachbaur D, Kropshofer G, Feichtinger H, Allerberger F, Niederwieser D: Cryptosporidiosis after CD34-selected autologous peripheral blood stem cell transplantation. *Bone Marrow Transplant* 19:1261–1263, 1997.
  23. Holmberg L, Boeckh M, Hooper H, et al. Increased incidence of cytomegalovirus disease after autologous CD34-selected peripheral blood stem cell transplantation. *Blood* 94:4029–4035, 1999.
  24. Lazarus HM, Pecora AL, Shea TC, et al. CD34<sup>+</sup> selection of hematopoietic blood cell collections and autotransplantation in lymphoma: overnight storage of product at 4°C does not affect outcome. *Bone Marrow Transplant* 25:559–566, 2000.
  25. Bomberger C, Singh-Jairam M, Rodey G, et al. Lymphoid reconstitution after autologous PBSC transplantation with FACS-sorted CD34<sup>+</sup> hematopoietic progenitors. *Blood* 91:2588–2600, 1998.
  26. Kiesel S, Pezzutto A, Körbling M, et al. Autologous peripheral blood stem cell transplantation: analysis of autografted cells and lymphocyte recovery. *Transplant Proc* 21:3084–3088, 1989.
  27. Talmadge JE, Reed EC, Kessinger A, et al. Immunologic attributes of cytokine mobilized blood stem cells and recovery following transplantation. *Bone Marrow Transplant* 17:101–109, 1996.

# Engraftment After High-Dose Therapy for Lymphoma With Low Doses of CD34<sup>+</sup> Peripheral Blood Stem Cells and Ex Vivo Expanded Bone Marrow Cells

**Gerald Effenbein, Shahid Malik, Andrew Pecora, Robert Preti,  
Mary Falvey, Deborah Morgan, Stuart Goldberg**

*Blood and Marrow Transplant Program (G.E., S.M., M.F., D.M.),  
Roger Williams Cancer Center, Providence, Rhode Island; Adult Blood  
and Marrow Stem Cell Program (A.P., S.G.), Hackensack University  
Medical Center, Hackensack, New Jersey; Progenitor Cell Therapy (R.P.),  
Hackensack, New Jersey*

## ABSTRACT

Limitation in the numbers of collected CD34<sup>+</sup> cells in a peripheral blood stem cell collection can mean that an otherwise curable patient may not receive high-dose chemotherapy because of the risk of delayed engraftment or nonengraftment. We explored the feasibility of adding ex vivo expanded bone marrow cells to limited CD34<sup>+</sup> cell dose peripheral blood stem cells—either of which would be expected to produce delayed engraftment—to accelerate engraftment. Rapid granulocyte recovery was seen in all 5 patients. Rapid platelet recovery was seen in 3 patients but in 2 patients who had previously received fludarabine, delayed platelet recovery was seen (perhaps only coincidentally).

## INTRODUCTION

The anticipation of delayed engraftment or failure to engraft after peripheral blood stem cell (PBSC) transplant is a contraindication to high-dose chemotherapy (HDCT), even though the patient's specific malignancy may be treatable with curative intent. The quantity and quality of PBSCs obtained after mobilization therapy may be inadequate to ensure prompt engraftment. Consequent prolonged pancytopenia after suboptimal-dose PBSC transplant may be too risky, in certain subpopulations of patients, because of high probabilities of infection, bleeding, and vital organ compromise.

There are a number of identifiable risk factors for potential poor engraftment after autologous PBSC transplant,<sup>1</sup> including older patient age, involvement of

bone marrow by the malignant disease process, prior chemotherapeutic drug exposures (eg, fludarabine or nitrogen mustard), and poor mobilization of stem cells into the peripheral blood (ie, low numbers of CD34<sup>+</sup> cells collected).<sup>2,3</sup> After the first attempt at PBSC collection has been considered poor, second attempts at mobilization have been tried.<sup>4</sup> Expansion of bone marrow cells (BMCs) *ex vivo* has been shown to be feasible on a large scale<sup>5</sup> and has resulted in successful hematopoietic engraftment.<sup>6</sup> The combination of expanded BMCs along with PBSCs may be advantageous to prevent delayed engraftment or failure to engraft.

After autologous PBSC transplants following HDCT when more than  $2 \times 10^6$  CD34<sup>+</sup> cells/kg are infused, engraftment is usually prompt, and when fewer than  $2 \times 10^6$  CD34<sup>+</sup> cells/kg are infused, engraftment may be delayed.<sup>2,3,7</sup> For patients with breast cancer receiving BMCs collected after granulocyte colony-stimulating factor (G-CSF) treatment and expanded *ex vivo* in the AastromReplicell, engraftment is disconcertingly slow.<sup>8</sup> However, when *ex vivo* expanded BMCs are infused along with very low doses of PBSCs ( $<1 \times 10^6$  CD34<sup>+</sup> cells/kg), the pace of engraftment is, surprisingly, nearly normal.<sup>8</sup>

We hypothesized that, for patients with Hodgkin's disease and non-Hodgkin's lymphoma (NHL) who have poor collections of PBSCs and other risk factors for poor engraftment, adding *ex vivo* expanded BMCs to suboptimal doses of PBSCs may improve the pace of engraftment after PBSC transplant.<sup>9</sup> This pilot feasibility study was performed at 2 institutions, the Roger Williams Medical Center (RWMC) in Providence, Rhode Island, and the Hackensack University Medical Center (HUMC) in Hackensack, New Jersey.

## MATERIALS AND METHODS

All patients who participated in this phase 1/2 study gave written informed consent to participate in protocols that were approved and annually reviewed by the respective institutional review boards of RWMC and HUMC. Characteristics of the 5 patients and their diseases that form the basis of this report of preliminary data are given in Table 1. Patients were deemed eligible to enter this study if their first PBSC mobilization regimen was suboptimal because it yielded fewer than  $1 \times 10^6$  CD34<sup>+</sup> cells/kg body weight (Table 2).

At RWMC, the mobilization regimen for PBSCs, called CPG, was cyclophosphamide (total of 3500 mg/m<sup>2</sup> in 2 doses per day), prednisone (2 mg/kg per day for 4 days) and G-CSF (10  $\mu$ g/kg per day starting on day 3 of chemotherapy). PBSCs were collected starting the day after the white blood cell count rose above 1000/ $\mu$ L. In poor PBSC mobilizers, in addition, G-CSF (alone) was given at 10  $\mu$ g/kg per day for 3 days, after which PBSC collection commenced with continuation of daily G-CSF. At HUMC, the mobilization regimen for PBSCs was G-CSF alone at 16  $\mu$ g/kg twice a day, commencing PBSC collection on the third day of G-CSF.

**Table 1.** Patient and Disease Characteristics\*

Patient	Age, y	Sex	Lymphoma		Shown in Bone Marrow Biopsy	Prior Therapy With Fludarabine or Nitrogen Mustard
			Histologic Type	Relevant Characteristic		
1	54	F	NHL	Intermediate Grade	Yes	Yes
2	69	M	NHL	Intermediate Grade	No	No
3	69	F	NHL	Low Grade	Yes	Yes
4	64	M	NHL	Low Grade	Yes	No
5	34	M	HD	Primary refractory	No	Yes

\*HD, Hodgkin's disease; NHL, non-Hodgkin's lymphoma.

At RWMC, the high-dose chemotherapy regimen, called CTC, consisted of cyclophosphamide (6000 mg/m<sup>2</sup>), thiotepa (500 mg/m<sup>2</sup>), and carboplatin (800 mg/m<sup>2</sup>) in 3 divided doses per day. The PBSC infusion was given 48–96 hours after the conclusion of chemotherapy, and G-CSF (5 µg/kg per day) was begun 1 day after the PBSC infusion. At HUMC, the high-dose chemotherapy regimen, called CBVA, was cyclophosphamide (90 mg/kg), BCNU (600 mg/m<sup>2</sup>), VP-16 (etoposide) (1600 mg/m<sup>2</sup>), and cytosine arabinoside (Ara-C) (15 mg/m<sup>2</sup>). The PBSC infusion was given 48 hours after the final dose of chemotherapy, and G-CSF (10 µg/kg per day) was begun 1 day after the PBSC infusion.

The clinical end points measured were, for myeloid engraftment, the first day of 3 consecutive days that the absolute granulocyte count (AGC) exceeded 500/µL and, for megakaryocytic engraftment, the first day of 3 consecutive days that the platelet count (PLT) exceeded 20,000/µL without platelet transfusion support.

Ex vivo marrow expansion was performed as follows. Upon bone marrow biopsy, if the cellularity was at least 20%, then a small marrow harvest (SMH)

**Table 2.** Stem Cell Harvests and Engraftment Times\*

Patient	CD34 <sup>+</sup> PBSCs After CPG, ×10 <sup>6</sup> /kg	CD34 <sup>+</sup> PBSCs After G-CSF, ×10 <sup>6</sup> /kg	Expanded BMCs, ×10 <sup>7</sup> /kg	First Day of ANC >500/µL	First Day of PLT >20,000/µL
1	0.3	1.0	3.0	14	>120
2	0.04	2.3	2.6	10	16
3	0.4	0.5	6.6	14	>120
4	—	0.8	1.0	13	20
5	0.4	0.6	1.0	10	16

\*ANC, absolute neutrophil count; BMC, bone marrow cell; CPG, cyclophosphamide, prednisone, G-CSF; G-CSF, granulocyte colony-stimulating factor; PBSC, peripheral blood stem cell; PLT, platelet count.

(80 mL bone marrow) was collected into heparinized syringes. The SMH was transported at 4°C to Progenitor Cell Therapy (Hackensack, NJ). Cells were cryopreserved using 10% dimethylsulfoxide (DMSO) (Research Industries) and stored at -135°C until use. On day -12 of transplant, the SMH cells were thawed and washed using a Gentran (Baxter) and Pulmozyme (Genentech) solution. Washed SMH cells were inoculated at a seeding density of 366 to 500 × 10<sup>6</sup> cells into each of 3 cell cassettes. Inoculates were cultured at 37°C for 12 days in the AastromReplicell using Iscove's modified Dulbecco's medium supplemented with fetal bovine serum, horse serum, hydrocortisone (Complete Medium; Aastrom BioSciences), erythropoietin (Amgen or Ortho Biotech), flt3-ligand (Immunex), PIXY321 (Immunex), L-glutamine (Gibco), gentamycin (Gibco), and vancomycin (Eli Lilly). Medium perfusion started on day 3 of culture. On the day of transplant, the expanded cells were released from the growth surface of the cell cassettes using trypsin, then washed, pooled, and transported to the transplant center at 4°C. The ex vivo expanded cells were reinfused at least 2 hours before the thawing and reinfusion of PBSCs (which were considered to be a suboptimal dose).

## RESULTS

Five patients were enrolled in this feasibility study. All had at least 2 and up to 4 risk factors for poor engraftment (Table 1), all had poor collections of PBSCs after their first attempt at mobilization (Table 2), and all had SMH expanded ex vivo (Table 3). For these 5 patients, ex vivo BMC expansion (Table 4) resulted on the average in a 60% increase in nucleated cells; a 75% reduction in CD34<sup>+</sup>, CD3<sup>-</sup>, CD11b<sup>-</sup>, CD15<sup>-</sup>, CD20<sup>-</sup>, glyA<sup>-</sup> cells (CD34<sup>+</sup> lineage-negative hematopoietic progenitors); a 13-fold increase in CD13<sup>+</sup>, CD3<sup>-</sup>, CD11b<sup>-</sup>, CD14<sup>-</sup>, CD20<sup>-</sup>, glyA<sup>-</sup> cells (CD13<sup>+</sup> myeloid progenitors); and a 6.2-fold increase in colony-forming units-granulocyte/macrophage (CFU-GM). All 5 patients had prompt AGC recovery (median, day 13) after limited-dose PBSCs and expanded BMCs were infused (Table 2). Three patients had prompt PLT recovery, but 2 patients had delayed PLT recovery. The median time of PLT recovery was day 20. In the only patient studied, CD20<sup>+</sup> cells were depleted from the ex vivo expanded BMC. It is worthy of note that 4 patients had sufficient hematopoietic reserve after the combination transplant to tolerate subsequent immunoconsolidation therapy with anti-CD20 antibody (*n* = 3) or extensive field irradiation therapy (*n* = 1).

## DISCUSSION

It is attractive to believe that any source of hematopoietic progenitor cells that are limited in number (ie, contain a low number of CD34<sup>+</sup> cells) may be expanded ex vivo and produce prompt and durable engraftment. One such example is

**Table 3.** Expanded Bone Marrow Cell Doses\*

Patient	Nucleated BMCs, $\times 10^7/\text{kg}$	$CD34^+Lin^-$ , $\times 10^6/\text{kg}^\ddagger$	$CD13^+LinB^-$ , $\times 10^6/\text{kg}^\ddagger$	CFU-GM, $\times 10^5/\text{kg}$
1	3.0	0.02	4.67	0.81
2	2.6	0.02	7.43	0.82
3	6.6	0.04	10.1	2.54
4	1.0	0.01	2.25	0.16
5	1.0	0.01	1.65	0.02
Mean	2.8	0.02	5.22	0.87

\*BMC, bone marrow cell; CFU-GM, colony-forming unit-granulocyte/macrophage;  $\ddagger Lin^- = CD3^-, CD11b^-, CD15^-, CD20^-, \text{ and } glyA^-$ ;  $\ddagger LinB^- = CD3^-, CD11b^-, CD14^-, CD20^-, \text{ and } glyA^-$ .

umbilical cord blood.<sup>10</sup> It is also attractive to believe that, if the first mobilization of  $CD34^+$  cells is insufficient to ensure rapid engraftment, it would be advantageous to collect more hematopoietic progenitor cells from the same source (the blood) or an alternative source (the marrow) to exceed a critical value of  $CD34^+$  cell content when the 2 collections are added together. Unfortunately, this does not always ensure prompt engraftment. When mobilization of a critical number of  $CD34^+$  cells into a blood-derived stem cell collection does not occur, merely exceeding the critical number with a second collection of hematopoietic progenitor cells derived from the bone marrow does not always ensure prompt engraftment.<sup>11</sup> As seen in breast cancer patients, ex vivo expanded BMCs alone did not ensure prompt engraftment, but adding ex vivo expanded BMCs to limited numbers of PBSCs was advantageous in preventing delayed engraftment.<sup>8</sup> Perhaps the same would be true in lymphoma patients, providing proof for the nascent principle.

From the observations reported in this communication, it is reasonable to conclude that it is feasible to harvest and expand a small amount of bone marrow even from patients with NHL who have disease in their marrow. In patients receiving suboptimal doses of PBSCs plus expanded BMCs, prompt granulocyte

**Table 4.** Bone Marrow Cell Fold Expansion\*

Patient	Nucleated BMCs	$CD34^+Lin^-$ Cells $^\ddagger$	$CD13^+LinB^-$ Cells $^\ddagger$	CFU-GM
1	2.0	0.19	13.2	9.2
2	1.4	0.62	10.4	8.0
3	1.8	0.27	13.17	8.4
4	1.0	0.10	8.82	4.8
5	0.6	0.08	18.0	0.6
Mean	1.4	0.25	12.72	6.2

\*BMC, bone marrow cell; CFU-GM, colony-forming unit-granulocyte/macrophage;  $\ddagger Lin^- = CD3^-, CD11b^-, CD15^-, CD20^-, \text{ and } glyA^-$ ;  $\ddagger LinB^- = CD3^-, CD11b^-, CD14^-, CD20^-, \text{ and } glyA^-$ .



recovery was seen in all patients, but delayed platelet recovery was seen in the 2 NHL patients with prior exposure to fludarabine (perhaps only coincidentally). These observations lead us to conclude that poor PBSC-mobilizing patients may still be candidates for curative intent therapy with high-dose chemotherapy as long as both small marrow harvest and an ex vivo expansion of BMCs can be performed.

At this point, only speculation can be made as to what cell population in the expanded bone marrow is responsible for the hastening of engraftment of PBSCs with limited CD34<sup>+</sup> cell content. One school of thought is that it is the additional CD34<sup>+</sup> cells. We, however, favor the hypothesis that it is microenvironmental progenitor cells that are responsible.<sup>12,13</sup>

## REFERENCES

1. Bensinger W, Appelbaum F, Rowley S, et al. Factors that influence collection and engraftment of autologous peripheral-blood stem cells. *J Clin Oncol* 13:2547–2555, 1995.
2. Pecora AL, Preti RA, Gleim GW, et al. CD34<sup>+</sup>CD33<sup>-</sup> cells influence days to engraftment and transfusion requirements in autologous blood stem cell recipients. *J Clin Oncol* 16:2093–2104, 1998.
3. Weaver CH, Hazelton B, Birch R, et al. An analysis of engraftment kinetics as a function of the CD34<sup>+</sup> content of peripheral blood progenitor cell collections in 692 patients after the administration of myeloablative chemotherapy. *Blood* 86:3961–3969, 1995.
4. Weaver CH, Tauer K, Zhen B, et al. Second attempts at mobilization of peripheral blood stem cells in patients with initial low CD34<sup>+</sup> cell yields. *J Hematother* 7:241–249, 1998.
5. Koller MR, Emerson SG, Palsson BO. Large-scale expansion of human stem and progenitor cells from bone marrow mononuclear cells in continuous perfusion cultures. *Blood* 82:378–384, 1993.
6. Stiff PJ, Oldenberg D, Hsi E, et al. Successful hematopoietic engraftment following high dose chemotherapy using only ex vivo expanded bone marrow grown in Aastrom (stromal based) bioreactors [abstract]. *Proc ASCO* 16:88, 1997.
7. Elfenbein GJ. Clinical factors contributing to the pace of engraftment after allogeneic and autologous stem cell transplantation: multivariate analyses. In: Abraham NG, Tabilio A, Martelli M, Asano S, Donfransco A, eds. *Molecular Biology of Hematopoiesis* 6. New York: Plenum Publishing, 1999, p. 103–111.
8. Pecora AL, Preti R, Jennis A, et al. AastromReplicell™ system expanded bone marrow enhances hematopoietic recovery in patients receiving low doses of G-CSF primed blood stem cells [abstract]. *Blood* 92 (Suppl 1):126, 1998.
9. Malik S, Pecora AL, Preti RA, et al. Engraftment after high dose therapy for non-Hodgkin's lymphoma (NHL) with low doses of CD34<sup>+</sup> peripheral blood stem cells and in vitro expanded bone marrow cells [abstract]. *Blood* 94 (Suppl 1):558, 1999.
10. Pecora AL, Stiff P, Jennis A, et al. Prompt and durable engraftment in two older adult patients with high risk chronic myelogenous leukemia (CML) using ex vivo expanded and unmanipulated unrelated umbilical cord blood: a case report. *Bone Marrow Transplant* 25:797–799, 2000.

11. Janssen WE, Elfenbein GJ, Perkins JB, et al. Final report of the first prospective, stratified, randomized trial comparing G-CSF primed bone marrow cells with G-CSF mobilized peripheral blood cells for pace of hematopoietic engraftment and disease free survival after high dose therapy and autotransplant. In: Dicke KA, Keating A, eds. *Autologous Blood and Marrow Transplantation: Proceedings of the Ninth International Symposium, Arlington, Texas*. Charlottesville, VA: Carden Jennings, 1999, p. 580–598.
12. Elfenbein GJ, Janssen WE, Perkins JB. Relative contributions of marrow microenvironment, growth factors, and stem cells to hematopoiesis in vivo in man: review of results from autologous stem cell transplant trials and laboratory studies at the Moffitt Cancer Center. In: Sackstein R, Janssen WE, Elfenbein GJ, eds. *Bone Marrow Transplantation: Foundations for the 21st Century; Annals of the New York Academy of Sciences*. Vol 770. New York, NY: New York Academy of Sciences, 1995, p. 315–339.
13. Elfenbein GJ, Janssen WE, Perkins JB, Partyka JS, Fields KK. Mathematical modeling of human hematopoiesis: lessons learned from the bedside following autologous peripheral blood stem cell transplants. In: Dicke KA, Keating A, eds. *Autologous Blood and Marrow Transplantation: Proceedings of the Eighth International Symposium, Arlington, Texas*. Charlottesville, VA: Carden Jennings, 1997, p. 443–466.

# **CHAPTER 14**

## **CORD BLOOD**



# Long-Term Engrafting Umbilical Cord Blood Cells Are Preserved After Ex Vivo Culture in Stroma-Free Culture

**K. Theunissen, I.D. Lewis, H. Liu, G. Almeida-Porada, J. Du,  
C. Scheller, A. Schmidt, I.R. Lemischka, K.A. Moore,  
J.E. Wagner, E.D. Zanjani, C.M. Verfaillie**

*Stem Cell Institute (K.T., I.D.L., H.L., J.D., C.S., A.S., J.E.W., C.M.V.),  
Department of Medicine and Cancer Center, University of Minnesota,  
Minneapolis, Minnesota; Department of Medicine (G.A.-P., E.D.Z.), Veterans  
Affairs Medical Center, University of Nevada, Reno, Nevada; Department of  
Molecular Biology (I.R.L., K.A.M.), Princeton University, Princeton, New Jersey*

## ABSTRACT

This article describes stroma-based and clinically applicable stroma-free cultures that maintain long-term engrafting umbilical cord blood (UCB) cells for at least 14 days ex vivo. UCB CD34<sup>+</sup> cells were cultured in transwells above AFT024 feeders (AFT-NC) with Flt-3 ligand (FL), stem cell factor (SCF), interleukin (IL)-7, and/or thrombopoietin (TPO) or in stroma-free cultures with glycosaminoglycans (GAGs) and the same cytokines found in stromal supernatants (SF). Progeny were transplanted into NOD-SCID mice or preimmune fetal sheep. SCID repopulating cells (SRCs) with multilineage differentiation potential were maintained in AFT-NC culture with FL/SCF/IL-7- or FL/TPO-containing cultures for up to 28 days. Marrow from mice engrafted with high levels of uncultured or expanded cells induced multilineage human hematopoiesis in 50% of secondary but no tertiary recipients. Day-7 expanded cells engrafted primary, secondary, and tertiary fetal sheep recipients. Whereas day-14 expanded cells engrafted primary and to a lesser degree secondary fetal sheep, they failed to engraft tertiary recipients. Likewise,  $\geq$ 14-day SF cultures maintained SRCs that could be transferred to secondary NOD-SCID recipients. This is the first demonstration that ex vivo culture in AFT-NC and stroma-free cultures maintains long-term engrafting cells—defined by their capacity to engraft secondary or tertiary hosts—and supports retroviral gene transfer into SRCs.

## INTRODUCTION

We have developed/examined a number of *ex vivo* expansion systems for primitive progenitors from adult bone marrow (BM), mobilized peripheral blood (PB), and UCB. Emphasis has been placed on stroma-based contact and noncontact systems. To determine the capacity of a given culture system to expand primitive progenitors, we enumerated the number of long-term culture–initiating cells (LTC-ICs), natural killer–initiating cells (NK-ICs), and *in vivo* repopulating cells before and after *ex vivo* culture. LTC-ICs are defined as cells able to generate colony-forming unit colonies after 5 weeks of culture.<sup>1</sup> NK-ICs are defined as cells capable of generating lymphoid progeny after 5 weeks of culture.<sup>2</sup> The majority of progeny cells are NK cells (CD56<sup>+</sup>CD3<sup>-</sup>), although there are also B-cell progenitors (CD19<sup>+</sup>) and dendritic-like cells (CD1a<sup>+</sup>). Finally, SRCs are defined as cells that can initiate human hematopoiesis in NOD-SCID mice (ie, >1% human CD45<sup>+</sup> cells 6 weeks after transplantation that coexpress human myeloid [CD15/CD33] antigens and lymphoid [CD19] antigens, determined by fluorescence-activated cell sorting [FACS] analysis).<sup>3</sup>

## PRECLINICAL STUDIES

LTC-ICs as well as NK-ICs can be maintained in a noncontact culture system in which the feeder is normal human BM stroma,<sup>1</sup> the M2-10B4 murine BM fibroblast feeder,<sup>4,5</sup> or the murine fetal liver feeder AFT-024.<sup>6–8</sup> Highest levels of expansion of UCB LTC-ICs and NK-ICs are obtained when cultured in a AFT024 contact or noncontact system containing combinations of SCF, IL-7, FL, and TPO. Culture in contact and noncontact systems leads to similar expansion.

We also showed that UCB NOD-SCID and fetal SRCs are maintained for 1–2 weeks in AFT024 noncontact cultures containing SCF, IL-7, and FL.<sup>7</sup> In experiments in which repopulating cells were enumerated in both primary and secondary recipients, we showed that UCB repopulating cells are maintained for up to 2 weeks *in vitro* in an AFT24 noncontact culture supplemented with SCF, IL-7, and FL.

We have identified factors secreted by hematopoietic supportive stromal feeders (M2-1-B4, AFT-024, or primary BM) that are important for the survival/expansion of LTC-ICs (and NK-ICs).<sup>4,9–12</sup> These include cytokines such as SCF, granulocyte- and granulocyte-macrophage colony-stimulating factor (G-CSF and GM-CSF), macrophage inflammatory protein (MIP)-1 $\alpha$ , IL-8, monocyte chemoattractant protein (MCP)-1, and vascular endothelial growth factor (VEGF). We have shown that highly 6-*O*-sulfated heparins produced by hematopoiesis-supportive feeders (M2-10B4, AFT024) mediate the formation of progenitor niches by colocalizing specific heparin-binding cytokines and matrix components (IL-3, MIP-1 $\alpha$ , platelet

factor [PF]-4, and thrombospondin [TSP]) with CD34<sup>+</sup> cells, thereby orchestrating the controlled growth and differentiation of stem cells. We demonstrated that addition of *O*-sulfated heparin to stroma-free cultures significantly improves maintenance/expansion of LTC-ICs and NK-ICs. We have shown that this is due to binding of MIP-1 $\alpha$ , IL-3, TSP, PF-4, VEGF, and fibronectin in a concentration-dependent manner to 6-*O*-sulfated heparin. In contrast, nonsupportive LTC-IC completely desulfated heparin, and *N*-sulfated heparin showed no binding to any of these proteins. Unmodified heparin, possessing a high degree of both *O*- and *N*-sulfation, also bound to all these proteins. The affinity of heparin for TSP was 4-fold higher than the affinity of *O*-sulfated heparin. Real-time binding kinetics by surface plasmon resonance showed that unmodified and *O*-sulfated heparins possess comparable affinities for the chemokine PF-4. However, the rates of association (on rate) and dissociation (off rate) of unmodified heparin were 2-log higher than those of *O*-sulfated heparin. Thus, the 6-*O*-sulfated nature of heparin sulfate glycosaminoglycans from the supportive cell line M210-B4 and AFT024 may allow adhesion of progenitors and cytokines, recreating the putative progenitor niche.

### CLINICALLY APPLICABLE EXPANSION CULTURES

Based on this information, we have reconstituted artificial stroma-conditioned medium: RPMI, 20% fetal calf serum, 6-*O*-sulfated heparin, 20–200 pg/mL SCF, G-CSF, GM-CSF, leukemia inhibitory factor, and MIP-1 $\alpha$ ; 10 ng/mL VEGF, IL-8, and MCP-1; and 10–20 ng/mL SCF, IL-7, and FL. This medium allows expansion of UCB LTC-ICs and NK-ICs at 2 and 5 weeks.<sup>13</sup> We have also examined the ability of these cultures to support SRCs *ex vivo*. Preliminary studies suggest that SRCs survive for 1 and 2 weeks *ex vivo* in this culture system. Additional studies are needed to demonstrate definitively whether SRCs are supported.<sup>8</sup>

### RETROVIRAL TRANSDUCTION OF CORD BLOOD PROGENITORS

We have used an adaptation of the AFT024 noncontact culture that allows expansion of LTC-ICs and NK-ICs and supports the growth and proliferation of myeloid/lymphoid-initiating cells (ML-ICs) to transduce primitive progenitors with murine leukemia virus-based vectors. We showed that a combination of 2 different means of overcoming Brownian motion, which interferes with cell-virus interaction (CH296 or transwell flow-through system), significantly enhances the transduction of BM, UCB, or PB CD34<sup>+</sup> cells and LTC-ICs.<sup>14</sup> When SCF, FL, IL-7, and SCF are added to the noncontact cultures on AFT024, we can obtain >80% transduction of ML-ICs, and possibly SRCs. The use of artificial

conditioned medium rather than the AFT024 noncontact culture system for transduction purposes is now being examined.

## CONCLUSIONS

We have developed a clinically applicable expansion culture system for cord blood cells that supports expansion of CFCs, LTC-ICs, and NK-ICs. This system at the least maintains SRCs that can be transferred to secondary recipients and also cells that engraft in the fetal sheep model that can be transferred to secondary and tertiary animals. However, the culture system still contains serum. We are in the process of reevaluating the media and determining whether similar results can be obtained with serum-free medium.

## ACKNOWLEDGMENTS

Supported in part by RO1-DK-53673 (C.M.V.), PO1-CA-65493 (C.M.V.), HL-52955 (E.D.Z.), HL-49042 (E.D.Z.), DK-51427 (E.D.Z.), the Veterans Administration, and Fairview University of Minnesota. C.M.V. is a Scholar of the Leukemia Society of America.

## REFERENCES

1. Verfaillie C, Blakolmer K, McGlave P. Purified primitive human hematopoietic progenitor cells with long-term in vitro repopulating capacity adhere selectively to irradiated BM stroma. *J Exp Med* 172:509–520, 1990.
2. Miller JS, Verfaillie CM, McGlave PB. The generation of natural killer cells from CD34<sup>+</sup>/DR<sup>-</sup> primitive progenitors in human long-term bone marrow culture. *Blood* 80:2182–2187, 1992.
3. Bhatia M, Bonnet D, Kapp U, Wang JC, Murdoch B, Dick JE. Quantitative analysis reveals expansion of human hematopoietic repopulating cells after short-term ex vivo culture. *J Exp Med* 186:619–624, 1997.
4. Burroughs J, Gupta P, Blazar B, Verfaillie C. Diffusible factors from the murine cell line M2-10B4 support human in vitro hematopoiesis. *Exp Hematol* 22:1095–1101, 1994.
5. Verfaillie C, Catanzarro P, Lin W-L. MIP-1 $\alpha$  combined with IL3 conserves primitive human LTBMIC for at least 8 weeks in ex vivo “stroma-non-contact” cultures. *J Exp Med* 179:643–649, 1994.
6. Punzel M, Wissink S, Aselson K, et al. Development of an in vitro assay that can enumerate myeloid-lymphoid initiating cells (ML-IC) in adult human bone marrow. *Blood* 93:3750–3756, 1999.
7. Lewis ID, Du J, Almeida-Porada J, Zanjani ED, Verfaillie CM. Long-term repopulating cord blood stem cells are preserved after ex-vivo culture in a non-contact system. *Blood*. In press.



8. Lewis ID, Verfaillie CM. Multi-lineage expansion potential of primitive hematopoietic progenitors: superiority of umbilical cord blood compared to mobilized peripheral blood. *Exp Hematol* 28:1087–1095, 2000.
9. Punzel M, Gupta P, Roodell A, Mortari F, Verfaillie C. Factor(s) secreted by AFT024 fetal liver cells following stimulation with human cytokines are important for human LTC-IC growth. *Leukemia* 13:1079–1084, 1999.
10. Gupta P, Oegema TJ, Brazil J, Dudek A, Slungaard A, Verfaillie C. Structurally specific heparan sulfates support primitive human hematopoiesis by formation of a multimolecular stem cell niche. *Blood* 92:4641–4651, 1998.
11. Gupta P, Oegema T, Verfaillie C. Differences in the LTC-IC maintaining capacity of stromal cells correlates with patterns of sulfation of their heparan sulfate glycosaminoglycans. *Blood*. In press.
12. Gupta P, McCarthy J, Verfaillie C. Stromal fibroblast heparan sulfate is required for cytokine-mediated ex vivo maintenance of human long-term culture-initiating cells. *Blood* 87:3229–3236, 1996.
13. Bhatia R, McGlave PB, Miller SJ, Wissink S, Lin WN, Verfaillie CM. A clinically suitable ex vivo expansion culture system for LTC-IC and CFC using stroma-conditioned medium. *Exp Hematol* 25:980–991, 1997.
14. Liu HJ, Hung Y, Wissink SD, Verfaillie CM. Improved retroviral transduction of hematopoietic progenitors by combining methods to enhance virus-cell interaction. *Leukemia* 14:307–311, 2000.

# Culture Conditions for Ex Vivo Expansion of Hematopoietic Primitive Cells

*L. Douay*

*St. Antoine and Trousseau Hospitals, Paris, France*

## ABSTRACT

The clinical value of ex vivo expansion of hematopoietic stem cells (HSCs) might be to increase the number of mature cells or the number of primitive stem cells. It is therefore essential to define the aims of hematopoietic cell expansion and adapt the experimental conditions to obtain the expected cell population for successful therapeutic use. HSC transplantation, indeed, requires expansion of all cellular subsets including precursors, progenitors, and primitive stem cells for short- and long-term engraftment of patients.

In this context, we and others have identified a number of important experimental parameters for bone marrow (BM) or cord blood (CB) expansion, notably: (1) CD34<sup>+</sup> cell selection rather than expansion of the total cells; (2) the importance of the input cell concentration; (3) the efficiency of a stroma-free system; and (4) a serum-free medium vs. the presence of serum. We further defined various combinations of cytokines that are able to expand precursors, progenitors, and the primitive compartment. Six cytokines were selected: stem cell factor (SCF), Flt3 ligand (FL), megakaryocyte growth and development factor (MGDF), interleukin (IL)-3, IL-6, and granulocyte colony-stimulating factor (G-CSF). We demonstrated the clinical relevance of culturing the cells in gas-permeable polypropylene bags, the functional capacity of the expanded mature cells, and the feasibility of subsequently freezing the expanded cells.

These conditions allow up to 1500-fold expansion of total cells, 150-fold increase of colony-forming cells (CFCs), and 40-fold augmentation of long-term culture-initiating cells (LTC-ICs) with the presence of primitive B and natural killer (NK) lymphoid progenitors. We also report the long-term multilineage capacity of ex vivo expanded cells under these conditions.

The potential clinical utility of the ex vivo expansion of HSCs is extensive. The aim can be to increase the number of mature cells, produce specific cells for adoptive therapy, or increase the number of primitive stem cells. In our experience, the establishment of controlled culture conditions is a prerequisite for the successful expansion of these cells for therapeutic use. In this context, we have

identified a number of important experimental parameters, notably the importance of the input-cell concentration, the value of a serum-free medium, and the efficiency of the cell container. We describe the long-term multilineage capacity of *ex vivo* expanded cells under these well-defined conditions.

## MATERIALS AND METHODS

### CB and BM Cell Preparation

CB samples were obtained after informed consent from healthy donors at the end of full-term deliveries, into sterile bags containing anticoagulant citrate-phosphate dextrose, at the Hospital Saint-Vincent de Paul, Paris. BM cells were obtained with informed consent from healthy donors. Samples were diluted 1:3 in phosphate-buffered saline (PBS) without  $\text{Ca}^{2+}$  and  $\text{Mg}^{2+}$  (Gibco, Life Technologies, Paisley, UK) before separation over Ficoll-Isopaque (density 1.077 g/mL; Seromed, Biochrom, Berlin, Germany). Low-density mononuclear cells were separated, washed, and resuspended in cold PBS without  $\text{Ca}^{2+}$  and  $\text{Mg}^{2+}$  plus 0.1% bovine serum albumin (StemCell Technologies, Vancouver, BC, Canada).  $\text{CD34}^+$  cells were isolated with superparamagnetic microbead selection using high-gradient magnetic field and miniMACS columns (Miltenyi Biotech, Glodbach, Germany).

### Liquid Cultures

$\text{CD34}^+$  cells were suspended at various concentrations ( $5 \times 10^3$ ,  $10^4$ ,  $5 \times 10^4$ , or  $10^5$  cells/mL) in serum-free long-term culture medium (LTCM)<sup>1,2</sup> supplemented with mast cell growth factor (MGF) or SCF (100 ng/mL), FL (100 ng/mL), IL-3 (5 ng/mL), IL-6 (10 ng/mL), and G-CSF (10 ng/mL)  $\pm$  MGDF (100 ng/mL) or erythropoietin (Epo) (0.5 U/mL) (complete LTCM). MGF and FL were kindly provided by Immunex (Seattle, WA), IL-3 and IL-6 by Sandoz (Basel, Switzerland), Epo by Behring (Marburg, Germany), G-CSF by Shugai Rhone Poulenc (Ukima, Japan), and MGDF by Amgen (Thousand Oaks, CA). The cell suspensions were incubated at 37°C in a 5%  $\text{CO}_2$ /95% air atmosphere for 14 days, after which the cells were collected, washed, and analyzed for progenitor cells, LTC-IC, immunophenotype, and cytology.

Culture assays were performed in either gas-permeable bags or tissue culture flasks. Using gas-permeable polypropylene bags (11.2 cm  $\times$  7.5 cm, PL2417; Baxter),  $\text{CD34}^+$  cells were seeded in 4 mL complete LTCM according to the manufacturer's recommendations. Fresh medium containing cytokines (16 mL) was added to each bag on day 6. According to our previous studies,<sup>3</sup> cells were removed on day 14 with a syringe and washed in Iscove's modified Dulbecco's

medium (IMDM) before analysis. Using tissue culture flasks (25-cm<sup>2</sup> T-flasks; Falcon, Heidelberg, Germany), CD34<sup>+</sup> cells were seeded in 4 mL complete LTCM according to our previously published procedure.<sup>4</sup> Fresh medium containing cytokines (4 mL) was added to each flask on day 6. On day 14, nonadherent cells were collected and mixed with adherent cells, which were recovered with a rubber scraper. The viable cells were then washed in Iscove's medium and assayed for progenitors.

### Progenitor Cell Assays

Burst forming units-erythroid (BFU-E) and colony forming units-granulocyte/macrophage (CFU-GM) were assayed in single-layer methylcellulose cultures. Cells were stimulated with 20 ng/mL G-CSF and granulocyte-macrophage (GM)-CSF (Shugai Rhone Poulenc), 10 ng/mL IL-3, 3 U/mL Epo, and 50 ng/mL SCF.

### Limiting Dilution Assay for LTC-IC

LTC-IC and extended (E)-LTC-IC were assayed as previously described,<sup>3</sup> with the cultures being performed during 5 and 10 weeks, respectively, on stroma layers established with a murine cell line (MS5) generously provided by K. Mori (Japan). LTC-IC and E-LTC-IC frequencies were determined by scaling the cultures down to a volume of 100  $\mu$ L in 96-well microtiter plates and performing limiting dilution assays with 20–50 replicates per step. Dilution steps were 2–64 cells/well for day 0 or day 14 CD34<sup>+</sup> cells. The total expanded population was assayed from 32 to  $1 \times 10^4$  cells/well, taking into account the cell expansion rate. Frequencies were calculated using Poisson statistics, from which we could deduce the absolute number of LTC-IC and E-LTC-IC as well as the number of CFC/LTC-IC.

### NK and B Lymphopoiesis Assays With Ex Vivo Expanded Cells

NK and B progenitors were assayed as previously described<sup>5</sup> in cultures on murine MS5 stroma layers in 24-well plates. Briefly,  $2 \times 10^4$  CD34<sup>+</sup> cells/well from day 0 and  $5 \times 10^5$  cells/well from day 14 of ex vivo expansion were plated in IMDM. For the B lymphopoiesis assay, the IMDM was supplemented with 3% fetal calf serum (FCS), 1% L-glutamine, 50 mM  $\beta$ 2-mercaptoethanol (M7522; Sigma), and 100 ng/ml FL. After 6 weeks of coculture, the cells were harvested for immunophenotyping.

For NK lymphopoiesis, the medium was supplemented with 1% L-glutamine, 10% human AB serum, 1000 U/mL IL-2 (Proleukine; Chiron, Suresne, France) and 24  $\mu$ M  $\beta$ 2-mercaptoethanol. After 5 weeks, the nonadherent cells were harvested for cytology and immunophenotype analysis.

## Functional Analyses

Normal bone marrow cells served as positive control cells in functional assays. Contaminating erythrocytes in the bone marrow samples were lysed by hypotonic shock before evaluation of the functional capacity of the remaining cells.

**Phagocytosis Assay.** Leukocyte phagocytosis was evaluated using heat-killed yeast (*Saccharomyces cerevisiae*; Sigma, St. Quentin Fallavier, France) as the test particle.<sup>6</sup> Results were expressed as the mean percentage of cells having internalized *S. cerevisiae* among the population of cells the most apt to phagocytose, in the range, namely, from monocytes or metamyelocytes to segmented neutrophils.

**Hydrogen Peroxide Assay.** H<sub>2</sub>O<sub>2</sub> production was measured by means of a flow cytometric assay employing 2',7'-dichlorofluorescein-diacetate (DCFH-DA; Kodak, France), as previously described. After preincubation with DCFH-DA at 37°C for 15 minutes, aliquots containing 10<sup>6</sup> cells/mL were incubated for a further 15 minutes in PBS with or without 50 ng/mL phorbol myristate acetate (PMA). Mean fluorescence intensities of cells were determined using a FACScan flow cytometer. Data were analyzed with Lysis II software, and the effect of PMA on H<sub>2</sub>O<sub>2</sub> production was calculated according to a stimulation index (ratio of mean fluorescence intensity of stimulated cells to that of unstimulated cells).

## Mice

NOD-LtSz-scid/scid (NOD-SCID) breeding pairs were originally obtained from Dr. J. Dick (Toronto, Ontario, Canada). Mice were produced in the animal facilities of the Institut Gustave Roussy (Villejuif, France) under sterile conditions in air-filtered containers. Before transplantation, 8-week-old NOD-SCID mice were given a sublethal dose of irradiation (3.5 Gy) (cobalt-60 Eldorado S irradiator; AECL Medical, Ontario, Canada). Mice were anesthetized briefly with ether during the intravenous injection of human hematopoietic cord blood CD34<sup>+</sup> cells (2×10<sup>3</sup> to 5×10<sup>4</sup> cells/mouse) or expanded cells generated from the same number of initial CD34<sup>+</sup> cells in the retro-orbital vein. Twenty weeks after transplantation, mice were killed and BM cells were obtained by flushing the mouse femurs and tibias with  $\alpha$ -minimal essential medium ( $\alpha$ -MEM)/10% FCS. Nucleated cells were counted and used for phenotypic analysis and/or assessment of hematopoietic progenitor cells. Human cell engraftment is expressed as the absolute number of different cell types calculated by multiplying the total number of cells obtained from 2 femurs and 2 tibias by the percent of human CD45<sup>+</sup> cells measured by flow cytometry.

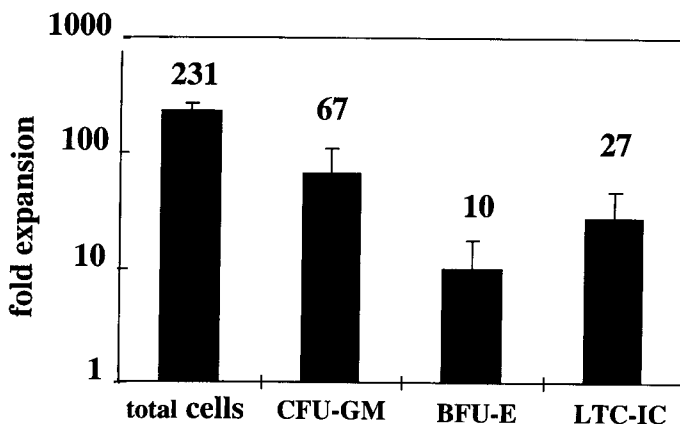
## RESULTS

Decreasing cell input from  $10 \times 10^4$  to  $0.5 \times 10^4$ /mL increases the expansion of all compartments: total cells, CD34<sup>+</sup>, CFU-GM, BFU-E, and LTC-IC, whatever the combination of cytokines used. Interestingly, the proportions of erythroid, monocytic, and granulocytic cells among expanded cells were found to depend also on the initial number of input cells to the culture: a lower cell input favored the production of erythroid cells, whereas a higher initial cell concentration favored the production of granulocytic cells, with terminal differentiation, up to neutrophils.

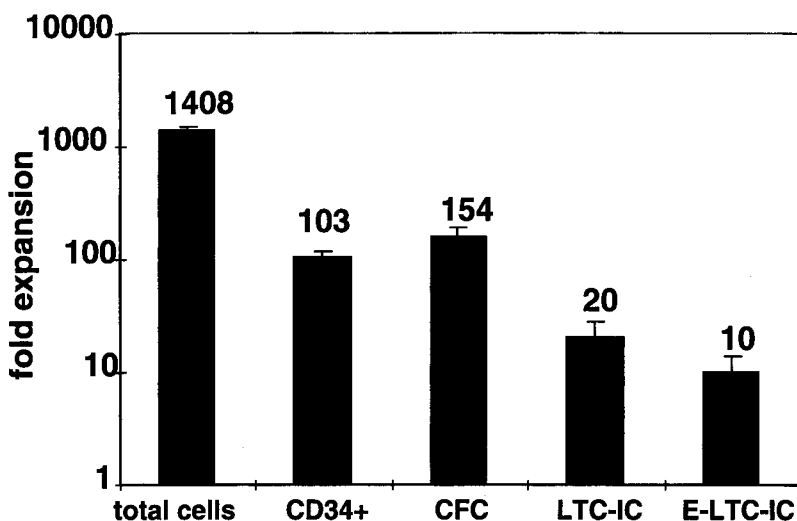
A serum-free medium is, in any case, better for cell expansion than any serum- or plasma-containing medium, from human or animal origin.

Flasks are not suitable for therapeutic use of expanded cells, because of the risk of sample contamination and the difficulty of manipulating large volumes of culture medium. Gas-permeable polypropylene bags are therefore of interest. In addition to their convenience, they allow a 2-fold higher expansion of nucleated cells, compared with flasks.

These observations taken together identify the most efficient conditions to date, in our hands: gas-permeable polypropylene bags,  $5 \times 10^4$  CD34<sup>+</sup> cells/mL for BM or  $1 \times 10^4$ /mL for CB, and serum-free and stroma-free medium for 14 days. The combination of cytokines we finally found to allow high-level expansion of all compartments appeared to differ for BM and CB cells: SCF, FL, MGDF, G-CSF, IL-6, and IL-3 for BM and SCF, FL, MGDF, and G-CSF for CB.



**Figure 1.** Expansion of bone marrow cells. BFU-E, burst-forming unit-erythroid; CFU-GM, colony-forming unit-granulocyte/macrophage; LTC-IC, long-term culture-initiating cell.



**Figure 2.** Cell expansion. CFC, colony-forming cell; E-LTC-IC, extended long-term culture-initiating cell; LTC-IC, long-term culture-initiating cell.

The levels of expansion of BM cells reached under these conditions are shown in Figure 1. In the case of the expansion of CD34<sup>+</sup> cord blood cells, under similar experimental conditions but with an initial cell concentration of  $1 \times 10^4$ /mL and a combination of SCF, FL, MGDF, and G-CSF, the results are as follows: the mean total cell expansion is 1500-fold, 100-fold for CD34<sup>+</sup> cells. When considering the myeloid compartment, CFCs are expanded up to 150-fold, 5-week LTC-ICs up to 20-fold, and 10-week E-LTC-ICs up to 10-fold (Figure 2).

To estimate the ability of the expanded cells to maintain their functions *in vivo* after infusion into patients, we analyzed various functional properties, such as phagocytosis and oxidative metabolism. Compared with normal BM cells, these

**Table 1.** Functional Capacity of Mature Expanded Bone Marrow Cells

	Normal Bone Marrow Control	Expanded Cells*
Percent phagocytic cells†	58 ± 4	45 ± 6
Intracellular H <sub>2</sub> O <sub>2</sub> production‡		
Responsive cells	35 ± 3	30 ± 5
Stimulation index	9 ± 1	3 ± 0.1

\*CD34<sup>+</sup> cells ( $5 \times 10^4$ /mL) in the presence of stem cell factor, interleukin-3, Flt-3 ligand, granulocyte colony-stimulating factor, and erythropoietin for 14 days. †Phagocytic activity toward heat-killed yeast opsonized with AB serum. ‡Flow analysis of dichlorofluorescein fluorescence after preincubation with 2',7'-dichlorofluorescein-diacetate.

expanded cells have the capacity to perform their biological functions, although at slightly lower levels (Table 1).

Consequently, extrapolating our data, we can expect the following doses of hematopoietic cells from a 50-mL bone marrow starting graft after 14 days of expansion:  $1 \times 10^6$  CD34<sup>+</sup> cells/kg,  $1 \times 10^5$  CFU-GM/kg, and  $3 \times 10^4$  LTC-IC/kg. Such an expansion would require only 500 mL of culture medium, which is clinically relevant. In fact, this suggests that reduced volumes of bone marrow could be expanded *ex vivo* in bags, with a view to potential clinical application for transplantation.

The infusion of expanded cells into a patient compels clinicians to carefully manage timing. Therefore, we investigated the possibility of cryopreserving the final *ex vivo* products. The total cell recovery after thawing was 45%, while the recovery of progenitors, LTC-IC, and E-LTC-IC ranged from 65% to 90%. Data are similar for BM and CB cells. The conclusion is clearly that expanded cells can be cryopreserved.

The question we then raised was related to the expansion of lymphoid cells under conditions that promote the expansion of myeloid progenitor/stem cells. Indeed, in the population harvested after 14 days, <0.2% of the cells expressed lymphoid antigens. The expanded cells were therefore assayed for lymphopoiesis and NK and B lineage differentiation. After 4 to 8 additional weeks of culture, the cells were harvested for immunophenotyping. In the day-14 expanded population, the mean detectable level of NK committed cells—that is, CD3<sup>7</sup>/CD56<sup>+</sup> cells—was 0.2%. After 5 weeks under NK conditions, this population reached a mean level of 71%, which corresponds to a 600-fold expansion in terms of absolute number. Similarly, in the day-14 expanded fraction, the mean concentration of CD19<sup>+</sup> cells was very low, <0.2%. When cultured under B conditions, the CD19<sup>+</sup> population progressively reached a plateau of 30%. Most of these cells were positive for CD10 but negative for CD14, CD33, and CD2. Taking into account the total cell expansion, this corresponds to a 65-fold expansion of the CD19<sup>+</sup> cells of the day-14 population (Table 2). We conclude from these data that the expanded products contain not only cells with myeloid potential, but also cells with lymphoid potential.

**Table 2.** Lymphopoiesis Assays in Expanded Cord Blood and Bone Marrow Populations\*

	NK Culture, %		B Culture, %	
	CD3 <sup>7</sup> /CD56 <sup>+</sup>	CD19 <sup>+</sup>	CD19 <sup>+</sup>	CD19 <sup>+</sup> /CD10 <sup>bright</sup>
Starting population	0.2 ± 0.1	0.1 ± 0.1	0.1 ± 0.1	0.1 ± 0.1
After culture	79 ± 9	23 ± 5	19 ± 3	

\*Data are mean ± SEM from 3–7 experiments.



We explored the capacity of these populations to generate dendritic cells. For that purpose,  $10^6$  day-14 expanded cells/mL were maintained in presence of GM-CSF, tumor necrosis factor (TNF)- $\alpha$ , SCF, and FL for the 5 first days. IL-13 was added from day 5 to day 12. As shown in the lower part of the slide, the generation of CD1a<sup>+</sup>/DR<sup>+</sup>/CD86<sup>+</sup>/CD14<sup>-</sup> dendritic cells was observed at day 12. Further incubation with lipopolysaccharide induced terminal differentiation, notably with expression of CD83 and an increase of other dendritic cell markers. As a whole,  $10^6$  expanded cells could generate  $9 \times 10^5$  dendritic cells.

We then addressed the question of the repopulating capacity of these expanded cells compared with that of nonexpanded CD34<sup>+</sup> cells, using the NOD-SCID mouse model. NOD-SCID mice were injected with fresh CD34<sup>+</sup> cells or day-14 expanded cells, after sublethal irradiation. The criteria for human cell engraftment were the presence of at least 0.1% CD45<sup>+</sup> cells, the presence of human myeloid and B-lymphoid cells, and the conservation of the cloning efficiency of the engrafted cells. To assess long-term engraftment, mice were analyzed 5 months after injection of  $5 \times 10^4$  CD34<sup>+</sup> cells, or the total cells obtained from their amplification. In both groups, all the mice had engrafted. A detailed analysis shows that human cell engraftment was comparable in terms of CD34<sup>+</sup> cells, myeloid CD15<sup>+</sup> and glycophorine A<sup>+</sup> cells, and B-lymphoid CD19<sup>+</sup> cells in the bone marrow of mice transplanted with expanded vs. nonexpanded cells. These grafted cells were able to give rise to human CFU-GM and BFU-E progenitors. Data on the engrafted mice argue strongly in favor of both the preservation of the multilineage capacity of these expanded cells and the conservation of their long-term reconstitution capacity.

## DISCUSSION

Considerable effort is currently directed to define culture conditions that enable optimal expansion of hematopoietic cells while maintaining LTC-IC levels during precursor/progenitor cell proliferation.<sup>9-11</sup> However, the majority of investigations to date have not been aimed at developing clinically feasible culture systems. The classic material support, a T-flask, does not allow easy medium replacement and requires complex manipulation, with the result that serious risks of contamination appear in some procedures. Gas-permeable bags represent an interesting alternative approach for large-scale expansion, notably through the use of a closed and easily manipulated system. The initial input concentration of cells in the bags influences the expansion of all hematopoietic compartments. Increasing this initial concentration induced the production of granulocytic cells with terminal differentiation while decreasing the overall extent of expansion. To assess the functional capacity of expanded neutrophils and monocytes, we tested their phagocytic activity and oxidative metabolism, two properties representing the terminal stages of functional granulocytic differentiation.<sup>12</sup> The expanded cells produced in cultures displayed

lower but nonnegligible phagocytic activity compared with normal control cells. These results suggest that the cultured cells have the capacity to perform the biological functions essential to host defense against bacterial infection, even if such functions are not equivalent to those of control cells from normal bone marrow.

It is of major importance for the clinician to collect all parameters relating to the expanded product before its infusion into the patient. The possibility of freezing expanded cells has not yet been investigated. Our data clearly demonstrate that it is possible to cryopreserve expanded progenitor/stem cells, including E-LTC-IC, although, as expected, the mature cells were less well recovered.

An objective of the present study was to show that a combination of cytokines—namely SCF, FL, MGDF, and G-CSF for CB or SCF, FL, MGDF, G-CSF, IL-3, and IL-6 for BM—can efficiently support the expansion of CD34<sup>+</sup> cord blood cells in a serum-free, stroma-free medium.<sup>13,14</sup> Thus, we showed that these conditions allowed high-level expansion of total nucleated cells, CD34<sup>+</sup> cells, CFU-GM, BFU-E, LTC-IC, and E-LTC-IC without loss of their CFC-generating capacity.<sup>15</sup> These results obtained in a clinical setting are consistent with previous studies using highly enriched progenitor preparations such as CD34<sup>+</sup>/CD38<sup>-</sup> or CD34<sup>+</sup>/Lin<sup>-</sup> cells.<sup>16,17</sup>

We then explored the lymphoid potential of the expanded CB cells. In the population harvested after 14 days, <0.2% of the cells expressed lymphoid antigens. Our data show that they nevertheless clearly retained NK- and B-cell potential. The present data suggest the persistence, or expansion, of B and NK lymphoid progenitors.<sup>5</sup>

One major objective was to collect *in vivo* evidence for the long-term multilineage reconstitution capacity of the above *ex vivo* expanded cells. Transplanted human cells can home and function during several months in the microenvironment of the murine NOD-SCID BM, where they proliferate and differentiate to produce large numbers of LTC-IC, CFC, and immature and mature myeloid, erythroid, and lymphoid cells.<sup>16-18</sup> Our current data indicate that after expansion, CB cells include a primitive compartment capable of long-term lymphoid/myeloid engraftment in the marrow of the NOD/SCID mice.

Taken together, our data showing the capacity of engrafted human cells to generate myeloid (LTC-IC and E-LTC-IC) and lymphoid (B, NK) progenitors strongly argue in favor of the totipotency of these expanded cells.

The experiments reported here show that CD34<sup>+</sup> cells, after 14-day expansion in serum-free, stroma-free liquid culture in presence of SCF, FL, MGDF, and G-CSF, retain their capacity to engraft sublethally irradiated NOD/SCID mice, with the ability for both long-term hematopoiesis and multipotent differentiation into myeloid and B-, NK-, T-lymphoid cells. These data constitute rationale for the clinical use of *ex vivo* expanded cells.

In conclusion, culture conditions are critical parameters that can affect the extent of expansion of the various hematopoietic pools. Careful monitoring of these

conditions allows the production of expanded populations that retain high levels of primitive progenitor/stem cells with myeloid and lymphoid potential. The capacity of these expanded populations to sustain multilineage long-term human hematopoiesis in NOD-SCID mice confirms the efficiency of this approach.

## REFERENCES

1. Drouet X, Douay L, Giarratana MC, Gorin NC. Human liquid bone marrow culture in serum-free medium. *Br J Hematol* 73:143–147, 1989.
2. Douay L, Giarratana MC, Mary JY, Gorin NC. Interleukin-2 interacts with myeloid growth factors in serum-free long-term bone marrow culture. *Br J Hematol* 86:475–482, 1994.
3. Kobari L, Giarratana MC, Poloni A, et al. Flt-3 ligand, MGFDF, Epo and G-CSF enhance ex vivo expansion of hematopoietic cell compartments in the presence of SCF, IL3 and IL6. *Bone Marrow Transplant* 21:759–767, 1998.
4. Poloni A, Giarratana MC, Firat H, Kobari L, Gorin NC, Douay L. The ex vivo expansion capacity of normal human bone marrow cells is dependent on experimental conditions: role of cell concentration, serum and CD34<sup>+</sup> cell selection in stroma-free cultures. *Hematol Cell Ther* 39:49–58, 1997.
5. Giarratana MC, Vergez V, Schmith C, et al. Presence of primitive lymphoid progenitors with NK or B potential in ex vivo expanded bone marrow cell cultures. *Exp Hematol* 28:46–54, 2000.
6. Verhasselt B, Kerre T, Naessens E, et al. Thymic repopulation by CD34<sup>+</sup> human cord blood cells after expansion in stroma-free culture. *Blood* 94:3644–3652, 1999.
9. Karlsson S. Treatment of genetic defects in hematopoietic cell function by gene transfer. *Blood* 78:2481–2492, 1991.
10. Emerson SG. Ex vivo expansion of hematopoietic precursors, progenitors, and stem cells: the next generation of cellular therapeutics [review]. *Blood* 87:3082–3088, 1996.
11. Von Kalle C, Glimm H, Schulz G, Mertelsmann R, Henschler R. New developments in hematopoietic stem cell expansion [review]. *Curr Opin Hematol* 5:79–86, 1998.
12. Glasser L, Fiederlein RL. Functional differentiation of normal human neutrophils. *Blood* 69:937–944, 1987.
13. Fernandez MN, Millan I, Gluckman E. Cord-blood transplants. *N Engl J Med* 340:1287–1288, 1999.
14. Laporte JP, Lesage S, Portnoi MF, et al. Unrelated mismatched cord blood transplantation in patients with hematologic malignancies: a single institution experience [abstract]. *Bone Marrow Transplant* 22 (Suppl 1):576, 1998.
15. Tsuji T, Itoh K, Nishimura-Morita Y, et al. CD34<sup>high</sup> CD38<sup>low/-</sup> cells generated in a xenogenic coculture system are capable of both long-term hematopoiesis and multiple differentiation. *Leukemia* 13:1409–1419, 1999.
16. Shah AJ, Smogorzewska EM, Hannum C, Crooks GM. Flt3 ligand induces proliferation of quiescent human bone marrow CD34<sup>+</sup>CD38<sup>-</sup> cells and maintains progenitor cells in vitro. *Blood* 87:3563–3570, 1996.
17. Petzer AL, Zandstra PW, Piret JM, Eaves CJ. Differential cytokines effects on primitive

- (CD34<sup>+</sup>CD38<sup>-</sup>) human hematopoietic cells: novel responses to Flt3-ligand and thrombopoietin. *J Exp Med* 183:2551–2558, 1996.
18. Lapidot T, Pflumio F, Doedens M, Murdoch B, Williams D, Dick J. Cytokine stimulation of multilineage hematopoiesis from immature human cells engrafted in SCID mice. *Science* 255:1137–1141, 1992.

# **CHAPTER 15**

## **TUMOR CELL CONTAMINATION**



# **Tumor Contamination of Transplanted Autologous Stem Cell Harvests and Outcome: Potential Confounding Impact of Stem Cell Dose**

**J. Graham Sharp, James O. Armitage, Philip J. Bierman,  
Wing C. Chan, Anne Kessinger, James C. Lynch, Elizabeth C. Reed,  
Stefano Tarantolo, Monica Traystman, Julie M. Vose**

*Cell Biology and Anatomy, Radiology and Radiation Oncology (J.G.S.);  
Office of the Dean, College of Medicine and Internal Medicine (J.O.A., M.T.);  
Pathology and Microbiology (P.J.B.); Internal Medicine-Oncology/Hematology  
(W.C.C., A.K., E.C.R., S.T., J.M.V.); Preventive and Societal Medicine  
(J.C.L.), University of Nebraska Medical Center, Omaha, Nebraska*

## **ABSTRACT**

A sequential series of studies examining the impact of minimal tumor contamination of stem cell harvests on outcome following autologous transplantation has been performed for patients with non-Hodgkin's lymphoma (NHL), Hodgkin's disease, and breast cancer with a follow-up of 5 or 10 years. In all patient groups where tumor cells were detected in the harvest, no matter the source of stem cells, a faster time to progression and/or death was observed than for recipients of tumor-negative harvests, although these differences were usually minor for patients with lower tumor burdens. Despite differences in time to progression, overall survival did not differ significantly for recipients of tumor-positive vs. tumor-negative harvests. These data imply that the detection of tumor cells in the stem cell harvests is a surrogate measure of tumor burden in the patients. In comparing blood vs. bone marrow as the source of reconstituting stem cells, recipients of tumor-contaminated bone marrow harvests generally progressed faster than recipients of blood stem cell harvests, perhaps because clonogenic differences between tumor cells in marrow vs. blood. A potential confounding influence was the 3–5 times increased number of mononuclear, stem, and progenitor cells infused with blood vs. marrow graft products, since infusion of a higher stem cell dose has been associated with better outcomes. This might explain the slight advantage in outcomes of blood stem cell vs. marrow autotransplant recipients in some studies and emphasizes the need for multivariate analysis of all potential variables in studies of tumor contamination of autologous stem cell harvests and outcomes.

## INTRODUCTION

High-dose therapy and autologous stem cell transplantation are increasingly employed as salvage and consolidative adjuvant therapy for patients with various malignancies.<sup>1,2</sup> Over the past decade, the preferred source of stem cells has changed from bone marrow to blood, because mobilized blood stem cells were found to provide advantages of rapid hematopoietic recovery of the recipient, economy, and convenience.<sup>3</sup>

Interest in defining the importance and impact of minimal tumor contamination of transplanted autologous stem cell harvests continues.<sup>4</sup> Many studies have reported on the incidence and frequency of tumor cell detection in stem cell harvests.<sup>5</sup> The variable results are influenced by the different sensitivities of the detection technologies used.<sup>6</sup> The few available reports on the clinical consequences of reinfusing tumor cells in stem cell harvests suggest that patients receiving even a minimally contaminated bone marrow harvest do less well than recipients of tumor-negative marrow harvests.<sup>7,8</sup> Whether this is due to relapse caused by reinfused tumor cells, as has been observed by genetically marking the contaminating tumor cells,<sup>9-11</sup> or whether the detection of tumor cells in the stem cell harvest is a surrogate marker of a greater tumor burden and consequently a poorer outcome is not clear. The importance (if any) of tumor contamination in blood stem cell harvests is uncertain, because few clinical studies have been reported of the impact of tumor contamination of blood stem cells on outcome.<sup>12</sup>

This report presents a reappraisal of the results of a series of studies of outcomes based on minimal tumor contamination of stem cell harvests transplanted at the University of Nebraska Medical Center from 1985 to 1999. The objective was to assess the significance of the contaminating tumor cells.

## MATERIALS AND METHODS

### Patients

The evaluable patient subgroups analyzed in these studies comprised 65 patients with NHL undergoing high-dose therapy and bone marrow or nonmobilized blood stem cell transplants from November 1985 to November 1988; 96 patients randomized to receive blood vs. bone marrow transplants from November 1993 to June 1997; 45 patients with Hodgkin's disease undergoing high-dose therapy and blood stem cell transplantation from June 1988 to March 1991; 38 patients with metastatic breast cancer undergoing high-dose therapy and bone marrow or nonmobilized blood stem cell transplants from January 1986 to October 1989; and 32 patients with stage II breast cancer, 4-9 positive lymph nodes, undergoing adjuvant high-dose therapy and mobilized blood stem cell transplantation from



February 1996 to May 1999. All patients gave informed consent for high-dose therapy and transplantation, as well as for the application of tumor detection techniques to their stem cell harvests. Most patients were followed until progression and death or to the present time. A small number of patients have been lost to follow-up.

### **Stem Cell Collection and Stem and Progenitor Cell Enumeration**

These procedures have been described elsewhere.<sup>13,14</sup> In general, for mobilized cell collections, either granulocyte colony-stimulating factor (G-CSF) or granulocyte-macrophage colony-stimulating factor (GM-CSF) was used as the mobilizing cytokine.

### **High-Dose Therapy and Transplant**

The high-dose therapy regimens employed for the lymphoma patients in these studies have been described for NHL patients,<sup>7,8</sup> for Hodgkin's disease patients,<sup>15</sup> for metastatic breast cancer patients,<sup>16</sup> and for the stage II, 4–9 positive node, breast cancer patients.<sup>3</sup>

### **Tumor Detection Techniques**

The most recent descriptions of the lymphoma detection technology employed in NHL were reported by Wu et al.<sup>17</sup> and Sharp and Chan.<sup>18</sup> The detection of morphologically abnormal CD30<sup>+</sup> cells in Hodgkin's disease is described in Sharp and Chan<sup>18</sup> and Sharp et al.<sup>19</sup> The detection of breast cancer cells by culture assays is described in reports by Sharp et al.<sup>20</sup> and by immunocytochemical and molecular techniques in Traystman et al.<sup>6</sup> For the purpose of this analysis, harvests were characterized as either positive or negative at the level of sensitivity of the assay employed, and no attempt was made to quantify the number of tumor cells in each harvest.

### **Statistical Analysis**

The median time to progression of the patients who progressed or died was calculated for each patient category along with the percentage of long-term disease-free survivors. Because the patient groups are relatively small, the confidence limits on these estimates are correspondingly large.

**Table 1.** Summary of the Impact of Tumor Contamination of Autologous Stem Cell Harvests on Time to Progression or Death and Overall Survival of Recipients

<i>Disease and Subgroup</i>	<i>Stem Cell Source</i>	<i>Median Time to Progression/Death, mo*</i>		<i>5- or 10-y Survival, %†</i>	
		<i>Tumor+</i>	<i>Tumor-</i>	<i>Tumor+</i>	<i>Tumor-</i>
Non-Hodgkin's lymphoma, 1985–1988	Bone marrow	14	55	18‡	36‡
	Nonmobilized blood	6	50	50‡	42‡
Non-Hodgkin's lymphoma, 1993–1997	Bone marrow	3	4	43§	78§
	Mobilized blood	11	25	38§	50§
Hodgkin's disease	Nonmobilized blood	15	52	41‡	42‡
Breast cancer stage IV	Bone marrow	2	5	0§	0§
	Nonmobilized blood	7	27	6§	8§
Breast cancer stage II (4–9 positive nodes)	Mobilized blood	12	16	67§	76§

\*Of patients who progressed. †All differences were nonsignificant. ‡10-year follow-up; §5-year follow-up.

## RESULTS

In all patient groups where tumor cells were detected, a faster time to progression or death was observed compared with recipients of tumor-negative harvests (Table 1). In some instances, the differences were minor. The proportion of long-term survivors did not differ between recipients of tumor-positive or -negative harvests (Table 1), suggesting that the primary difference in outcomes between recipients of tumor-positive and -negative harvests was time to progression. In situations where comparisons could be made (NHL 1993–1997 and breast cancer stage IV), the majority of recipients of marrow autografts progressed faster than recipients of blood stem cell harvests. For nonmobilized blood stem cell recipients, patients (with NHL, Hodgkin's disease, or stage IV breast cancer) who received tumor-negative harvests experienced slower progression than recipients of tumor-positive harvests. The ultimate proportion of disease-free survivors did not differ between tumor-positive and -negative recipients, however, again suggesting that the primary difference in outcome between tumor-positive and -negative recipients was in time to progression.

Patients with earlier stage disease, eg, stage II (4–9 positive lymph nodes) breast cancer or NHL 1993–1997 (Table 1), with presumed lower tumor burdens, who received mobilized blood stem cell harvests exhibited less difference in time to progression or death between tumor-positive and -negative recipients. Because these studies involved patients with earlier stage disease, follow-up may be too short for valid conclusions. Comparisons of the proportion of marrow and blood

**Table 2.** Molecularly Positive Harvests Exhibiting Significant (1-Month) Growth of Tumor Cells in Culture

<i>Disease</i>	<i>Stem Cell Source</i>	<i>n</i>	<i>Molecularly Tumor-Positive Harvests, %</i>	<i>Positive Harvests Exhibiting Tumor Growth in Culture, %</i>
Non-Hodgkin's lymphoma	Bone marrow	81	42	74
	Mobilized blood	29	66	56
Breast cancer (high risk and metastatic)	Bone marrow	45	35	100
	Mobilized blood	23	48	9

harvests with molecularly detected tumor cells vs. the proportion that grew in culture (Table 2) showed that mobilized blood stem cell harvests containing molecularly detected tumor cells were less likely to be clonogenic in culture than tumor cells present in bone marrow harvests (Table 2).

The estimated number of both hematopoietic stem and progenitor cells and mononuclear cells transplanted differed between the recipients of cytokine-mobilized and nonmobilized blood stem cell transplants and bone marrow harvests (Table 3). The recipients of both nonmobilized and cytokine-mobilized blood stem cell transplants received 3- to 5-fold higher mononuclear cell doses than recipients of bone marrow transplants. The recipients of cytokine-mobilized blood stem cell harvests received 3- to 4-fold greater stem and progenitor cell doses than the marrow recipients (Table 3). Nonmobilized blood stem cell recipients received the lowest stem cell dose. A confounding factor in the interpretation of the importance to clinical outcome of tumor cells in transplanted stem cell harvests is the dose of cell subpopulations infused.<sup>21-24</sup> In this series, the outcome for nonmobilized blood stem cell recipients was not different from that of bone marrow recipients who received a higher stem cell dose but lower mononuclear cell dose, and the outcomes of recipients of cytokine-mobilized harvests appeared slightly better than those of bone marrow based on time to progression, but not overall survival. Consequently, the individual roles in outcomes of transplanted mononuclear vs. stem/progenitor cell dose in this series cannot be resolved.

## DISCUSSION

The primary difference in outcomes for recipients of tumor-contaminated stem cell harvests compared with negative harvests was a faster time to progression. This aspect of the studies supports, but does not confirm, the hypothesis that reinfused tumor cells contribute to relapse. The observation of longer times to progression of recipients of nonmobilized blood stem cell harvests that are less likely contaminated with tumor cells than bone marrow harvests or cytokine-

**Table 3.** Estimated Number of Stem/Progenitor Cells Transplanted in Recipients of Bone Marrow vs. Blood Stem Cell Transplants

Disease	Stem Cell Source	Average No. Cells Transplanted	
		Mononuclear, $\times 10^8/\text{kg}$	CFC-GM, $\times 10^4/\text{kg}^*$
Non-Hodgkin's lymphoma	Bone marrow	1-2.0†	3.2
	Nonmobilized blood	10.5	0.5
	Mobilized blood	9.0	12.6
Breast cancer	Bone marrow	~2.0	3.1
	Nonmobilized blood	7.2	0.7
	Mobilized blood	9.2	8.4

\*Colony-forming cell-granulocyte/macrophage (CFC-GM) was the only consistently applied stem/progenitor cell assay for all patients and is employed as a surrogate for infused stem/progenitor cell content. †Harvests were collected to achieve a predetermined mononuclear cell target, in the case of marrow  $2 \times 10^8/\text{kg}$  predicted on the basis of the cell count after 300 mL harvest. This target was achieved more often in breast cancer patients than in lymphoma patients.

mobilized blood stem cell harvests in patients with the same disease<sup>5,25,26</sup> is also supportive of this conclusion.

If this were the sole explanation, recipients of tumor-negative harvests should have a significantly greater disease-free survival. In fact, the proportion of long-term survivors did not differ significantly between recipients of tumor-negative vs. tumor-positive harvests. Consequently, alternative explanations are likely. The data are more compatible with the proposition that the detection of tumor cells in stem cell harvests identifies patients with a greater tumor burden and, consequently, a shorter time to progression of their disease. The stem cell harvests judged to be tumor negative likely were not free of tumor cells. Rather, the tumor burden of these patients was low and tumor cells in the harvests too rare to be detected by the techniques employed. Indeed, recent applications of tumor-enrichment techniques have demonstrated an increased frequency of contamination.<sup>25,27</sup> Although a much longer time elapses (up to 10 years) before patients with purportedly negative harvests progress, this ultimately occurs, resulting in no significant differences in overall survival between recipients of tumor-positive and -negative harvests. A reanalysis in the next few years of the high-risk breast cancer patients who received tumor-positive or -negative bone marrow harvests reported by Vredenburgh et al.<sup>28</sup> will be informative in this regard. Seven years from diagnosis, the recipients of tumor-negative harvests had a significantly better outcome, but this advantage may be lost with time. A somewhat related situation exists when the detection of micrometastasis is used to predict the long-term

outcome of breast cancer patients undergoing surgical removal of their primary tumors. Micrometastasis detection is an independent predictor of a poorer outcome initially but not long term.<sup>29</sup>

The above explanation of observations is relevant to the interpretation of studies comparing high-dose therapy and transplantation to intense standard therapy. High-dose therapy is postulated to increase tumor cell kill, with a corresponding reduction in tumor burden, compared with intense standard therapy, leading to the prediction that the most likely difference between the 2 arms will be in time to progression of relapsing patients rather than a difference in long-term survival. Only those patients with tumor burdens that can be reduced to a very low value (or zero) by the high-dose therapy compared with conventional therapy could be expected to be cured. If the discredited South African study is discounted, 2 studies (Peters et al.<sup>30</sup> and PEGASE<sup>31</sup>) showed an increased time to progression in the high-dose therapy arm, as predicted. It is too early to evaluate long-term survival. Potential problems with other studies have been described by Peters et al.<sup>30</sup> As the tumor burden is decreased, the range of tumor burdens in the patient cohort is compressed, and it may be increasingly difficult to demonstrate a difference in time to progression (Table 1). In this group of patients, however, the proportion achieving cured status should increase. The most relevant end point might differ based on the tumor burdens of the patients undergoing therapy.

Controversy has developed as to whether blood is a better stem cell source than bone marrow, based on tumor contamination.<sup>32</sup> Faster hematopoietic reconstitution, convenience, and economic issues have swung the pendulum firmly in favor of the use of blood stem cells without regard to the role of tumor contamination.<sup>3</sup> Generally, the number of tumor cells per nucleated cell in the blood is lower than in bone marrow and is translated into a lower frequency of patients with contaminated blood stem cell harvests.<sup>5,33</sup> The application, since 1991, of cytokines to mobilize blood stem cells, concurrently with increasing sensitivity of tumor detection techniques, appeared to suggest that the use of cytokines mobilized tumor cells as well as stem cells into the circulation (Table 2). There is no doubt that in individual patients tumor cell mobilization occurs,<sup>5,34,35</sup> but this may affect a minority of patients. In a multivariate analysis performed in NHL patients, the only significant correlate of tumor cell contamination of the harvest was the mononuclear cell count.<sup>36</sup> Since the use of cytokines for mobilization increased the number of mononuclear cells as well as stem and progenitor cell content of the harvest, this may be the basis of the association of cytokine use with increased stem cell harvest contamination rather than tumor cell mobilization per se.

The biological properties of tumor cells in the circulation and in bone marrow appear to differ, even though they overlap. Molecularly detected tumor cells in blood are less likely to be clonogenic compared with similarly detected cells from bone marrow, especially in the case of breast cancer (epithelial) cells (Table 2).

Tumor cells in bone marrow also associate with stromal cells and/or certain extracellular molecules and appear to express genes that inhibit apoptosis and confer chemoresistance.<sup>37,38</sup> This may be the basis of the predictive ability of the presence of bone marrow micrometastases for outcome.<sup>39</sup> The observation of tumor cells in the circulation or in blood stem cell harvests is much less predictive of outcomes, probably because many of these cells are effete, non-clonogenic, or destined to undergo apoptosis. The importance of these differences will be amplified if, as proposed above, the primary significance of the detection of tumor cells in stem cell harvests is as a surrogate for tumor burden.

There is an additional, more recently recognized, uncontrolled variable in most studies of transplanted blood vs. bone marrow stem cell harvests, in that the infused mononuclear cell and stem cell content of a cytokine-mobilized blood stem cell harvest is generally greater than that of a bone marrow harvest (Table 3). A preliminary analysis showed that for recipients of normal donor cells, the posttransplant recovery of immune cells (CD4, CD8, CD56, CD19) tracked much more closely with the infused mononuclear and CD34<sup>+</sup> (also CD56<sup>+</sup>) cell dose than with the infused immune cell (CD4<sup>+</sup> or CD8<sup>+</sup>) dose.<sup>40</sup> Similar observations were reported by Hangretinger et al.<sup>41</sup> in studies of megadoses of transplanted CD34<sup>+</sup> cells in the haploidentical situation. The high CD34<sup>+</sup> cell doses were associated with faster immunological recoveries. Higher stem cell doses are reported to be associated with improved outcomes in elderly leukemia patients<sup>22</sup> and recipients of mafosfamide purged stem cell harvests<sup>23</sup> as well as in allogeneic transplant recipients.<sup>21,24</sup> Consequently, the prediction from these observations is that a greater proportion of the patients who relapse, regardless of the tumor contamination of their harvest, might have received lower numbers of transplanted stem cells. Cytokine-mobilized blood stem cell recipients, because they generally receive more stem cells, should have fewer relapses (or perhaps, longer average times to progression) than bone marrow recipients. This does not appear to be the case for nonmobilized blood stem cell recipients who, based on the colony-forming cell-granulocyte/macrophage (CFC-GM) content of their harvest, received low stem cell doses but did not have a worse outcome. Other factors such as mononuclear cell dose may also be important. A multivariate analysis of the outcomes of these patients based on both stem cell number transplanted and tumor-negative vs. -positive harvests should further segregate good outcomes for recipients of tumor-negative, high stem cell number harvests compared with recipients of tumor-positive, low stem cell number harvests with poorer outcomes.

Testing these postulates is important because they contradict the trend toward minimizing the number of apheresis employed, providing a sufficient number of CD34<sup>+</sup> cells to achieve rapid hematologic reconstitution is obtained. This number of CD34<sup>+</sup> cells may not be sufficient for rapid immunological reconstitution or optimal outcomes.<sup>40</sup> However, increasing the mononuclear and stem cell doses will

also increase the likelihood of tumor contamination. This influence could be decreased by purging the tumor cells from the harvest, but only if this can be accomplished without significant loss of stem or progenitor cells.<sup>22</sup> How these two interrelated but opposing influences on clinical outcome ultimately play out remains to be determined.

## ACKNOWLEDGMENTS

It is a privilege to thank the members of the UNMC Transplant Teams and the laboratory technologists who assisted with these studies and Penni Davis, who typed the manuscript. These studies were originally supported by the American Cancer Society, and subsequently by the National Institutes of Health. This support is gratefully acknowledged.

## REFERENCES

1. Armitage JO. The development of bone marrow transplantation as a treatment for patients with lymphoma: Twentieth Richard and Hinda Rosenthal Foundation Award Lecture. *Clin Cancer Res* 3:829–836, 1997.
2. Vahdat K, Antman K. Dose-intensive therapy for breast cancer. In: JO Armitage, Antman KH, eds. *High-Dose Cancer Therapy: Pharmacology, Hematopoietins, Stem Cells*. 3rd ed. Philadelphia, PA: Lippincott Williams & Wilkins, 2000, p. 821–839.
3. McGuire TR, Tarantolo S, Reed E. Peripheral blood progenitor cells: enabling outpatient transplantation. *Pharmacotherapy* 18:17s-23s, 1998.
4. Sharp JG. Marrow contamination: minimal disease: detection and significance. In: JO Armitage, Antman KH, eds. *High-Dose Cancer Therapy: Pharmacology, Hematopoietins, Stem Cells*. 3rd ed. Philadelphia, PA: Lippincott Williams & Wilkins, 2000, p. 301–330.
5. Ross AA, Layton TJ, Ostrander AB, et al. Comparative analysis of breast cancer contamination in mobilized and nonmobilized hematopoietic grafts. *J Hematother* 5:549–552, 1996.
6. Traystman MD, Cochran GT, Hake SJ, et al. Comparison of molecular cytokeratin 19 reverse transcriptase polymerase chain reaction (CK19 RT-PCR) and immunocytochemical detection of micrometastatic breast cancer cells in hematopoietic harvests. *J Hematother* 6:551–561, 1997.
7. Sharp JG, Joshi SS, Armitage JO, et al. Significance of detection of occult non-Hodgkin's lymphoma in histologically uninvolved bone marrow by a culture technique. *Blood* 79:1074–1080, 1992.
8. Sharp JG, Kessinger A, Mann S, et al. Outcome of high-dose therapy and autologous transplantation in non-Hodgkin's lymphoma based on the presence of tumor in the marrow or infused hematopoietic harvest. *J Clin Oncol* 14:214–219, 1996.
9. Brenner MK, Rill DR, Moen RC, et al. Gene-marking to trace origin of relapse after autologous marrow transplantation. *Lancet* 341:85–86, 1993.
10. Rill DR, Santana VM, Roberts WM, et al. Direct demonstration that autologous marrow

- transplantation for solid tumors can return a multiplicity of tumorigenic cells. *Blood* 84: 380–383, 1994.
11. Deisseroth AB, Zu Z, Claxton D, et al. Genetic marking shows that Ph<sup>+</sup> cells present in autologous transplants of chronic myelogenous leukemia (CML) contribute to relapse after autologous bone marrow transplantation in CML. *Blood* 83:3068–3076, 1994.
  12. Sharp JG, Chan W, Wu G, et al. Comparison of culture versus molecular detection of lymphoma in the context of a randomized prospective trial of blood versus marrow for reconstitution after high dose therapy: an interim analysis. In: Dicke KA, Keating A, eds. *Autologous Marrow and Blood Transplantation: Proceedings of the Eighth International Symposium, Arlington, Texas*. Charlottesville, VA: Carden Jennings, 1997, p. 473–484.
  13. Kessinger A, Bishop MR, Jackson JD, et al. Erythropoietin for mobilization of circulating progenitor cells in patients with previously-treated relapsed malignancies. *Exp Hematol* 23:609–612, 1995.
  14. Kessinger A. Collection of autologous peripheral blood stem cells in steady state. In: Gorin, Ed. *Baillière's Best Practice & Research, Clinical Haematology, Peripheral Stem Cells in Bone Marrow Transplantation*, Vol. 12. London, UK: Bailliere Tindal, 1999, p. 19–26.
  15. Bierman P, Jagannath S, Armitage J, et al. High dose cyclophosphamide, carmustine, and etoposide in Hodgkin disease: follow-up of 128 patients. In: Dicke KA, Armitage JO, Dicke-Evinger MJ, eds. *Proceedings of the Fifth International Symposium: Autologous Bone Marrow Transplantation*. Omaha, NE: University of Nebraska Medical Center, 1991, p. 519–527.
  16. Sharp JG, Vaughan WP, Kessinger A, et al. Significance of detection of tumor cells in hematopoietic stem cell harvests of patients with breast cancer. In: Dicke KA, Armitage JO, Dicke-Evinger MJ, eds. *Proceedings of the Fifth International Symposium: Autologous Bone Marrow Transplantation*. Omaha: University of Nebraska Medical Center, 1991, p. 385–391.
  17. Wu GQ, Sharp JG, Vose J, Greiner TC, Chan WC. The detection of minimal lymphoma by molecular and combined culture-molecular methods. *Br J Haematol* 99:873–881, 1997.
  18. Sharp JG, Chan WC. Detection and relevance of minimal disease in lymphomas. *Cancer Metastasis Rev* 18:127–142, 1999.
  19. Sharp JG, Kessinger A, Armitage JO, et al. Clinical significance of occult tumor cell contamination of hematopoietic harvests in non-Hodgkin's lymphoma and Hodgkin's disease. In: Zander AR, Barlogie B, eds. *Autologous Bone Marrow Transplantation for Hodgkin's Disease, Non-Hodgkin's Lymphoma and Multiple Myeloma*. Berlin, Germany: Springer-Verlag, 1993, p. 123–132.
  20. Sharp JG, Mann SL, Murphy B, Weekes C. Culture methods for the detection of minimal tumor contamination of hematopoietic harvests: a review. *J Hematother* 4:141–148, 1995.
  21. Sierra J, Storer B, Hansen JA, et al. Transplantation of marrow cells from unrelated donors for treatment of high risk acute leukemia: the effect of leukemic burden, donor HLA-matching and marrow dose. *Blood* 89:4226–4235, 1997.
  22. Gorin NC, Labopin M, Laporte JP, et al. Importance of marrow dose on posttransplant



- outcome in acute leukemia: models derived from patients autografted with mafosphamide-purged marrow at a single institution. *Exp Hematol* 27:822–1830, 1999a.
23. Gorin NC, Labopin M, Richard P, Sierra J, Frassoni F. High dose of peripheral blood stem cells is critical to improve the outcome of patients over 60 years of age autografted for acute myelocytic leukemia (AML) [abstract]. Presented at the Peripheral Blood Stem Cell Transplantation International Symposium, Mulhouse, France, Sept. 5–8, 1999.
  24. Anasetti C, Heimfeld S, Rowley S, et al. Higher CD34<sup>+</sup> cell dose is associated with improved survival after marrow transplantation from unrelated donors [abstract]. *Blood* 561a (Suppl 1), 1999.
  25. Ross AA, Cooper BW, Lazarus HM, et al. Detection and viability of tumor cells in peripheral blood stem cell collections from breast cancer patients using immunocytochemical and clonogenic assay techniques. *Blood* 82:2605–2610, 1993.
  26. Dominice C, Deb G, Angioni A, et al. Peripheral blood stem cells in children with solid tumors, II: immunocytologic detection of tumor cells in marrow and peripheral blood stem cells harvests. *Anticancer Res* 13:2573–2575, 1993.
  27. Krag D, Ashikaga T, Moss T, et al. Breast cancer cells in the blood: a pilot study. *Breast J* 5:354–358, 1999.
  28. Vredenburgh JJ, Silva O, Broadwater G, et al. The significance of tumor contamination in the marrow from high-risk primary breast cancer patients treated with high-dose chemotherapy and hematopoietic support. *Biol Blood Marrow Transplant* 3:91–97, 1997.
  29. Mansi JL, Gogas H, Bliss JM, Gazet JC, Berger U, Combes RC. Outcome of primary-breast-cancer patients with micrometastases: a long-term follow-up. *Lancet* 354:197–202, 1999.
  30. Peters WP, Dansey RD, Klein JL, Baynes RD. High dose chemotherapy and peripheral blood cell transplantation in the treatment of breast cancer. *Oncologist* 5:1–13, 2000.
  31. Gluck S, Stewart D. High-dose therapy in breast cancer: out of favor but not out of promise. *Bone Marrow Transplant* 25:1017–1019, 2000.
  32. Kessinger A. Is blood or bone marrow better? *Stem Cells* 11:290–295, 1993.
  33. Ross AA. Minimal residual disease in solid tumor malignancies: a review. *J Hematother* 7:9–18, 1998.
  34. Brugger W, Bross KJ, Glatt M, Weber F, Mertelsmann R, Kanz L. Mobilization of tumor cells and hematopoietic progenitor cells into peripheral blood of patients with solid tumors. *Blood* 83:636–640, 1994.
  35. Shpall EJ, Jones RB. Release of tumor cells from marrow. *Blood* 83:623–625, 1994.
  36. Demirkazik A, Armitage JO, Bierman PJ, Lynch J, Vose J, Sharp JG. Factors affecting progenitor cell and tumor cell content of blood stem cell harvests of lymphoma patients [abstract]. *Blood* 92 (Suppl 1):118a, 1998.
  37. Weekes CD, Pirruccello SJ, Vose JM, Kuszynski C, Sharp JG. Lymphoma cells associated with bone marrow stromal cells in culture exhibit altered growth and survival. *Leuk Lymphoma* 31:151–165, 1998.
  38. Weekes CD, Kuszynski CA, Sharp JG. VLA-4 mediated adhesion to bone marrow stromal cells confers chemoresistance to adherent lymphoma cells. *Leuk Lymphoma*. In press.
  39. Braun S, Pantel K, Muller P, et al. Cytokeratin-positive cells in the bone marrow and survival of patients with stage I, II, or III breast cancer. *N Engl J Med* 342:525–533, 2000.

40. Sharp JG, Kessiner A, Lynch JC, Pavletic ZS, Joshi SS. Blood stem cell transplantation: factors influencing immunological reconstitution. *J Hematother*. In press.
41. Handgretinger R, Schumm M, L'nag P, et al. Transplantation of megadoses of purified haploidentical stem cells. *Ann N Y Acad Sci* 872:351–362, 1999.

# Clinical Relevance of Micrometastases in Solid Tumors

*Klaus Pantel, Marcus Otte*

*Molekulare Diagnostik und Therapie, Universitätsfrauen-klinik,  
Universitäts-Krankenhaus Eppendorf, Hamburg, Germany*

## ABSTRACT

Malignant tumors of epithelial tissue, the most common form of cancer, are responsible for the majority of cancer-related deaths in Western industrialized countries. As a result of progress in surgical treatment of these tumors, lethality is linked increasingly with early metastasis, which is generally occult at the time of primary diagnosis. The decision whether systemic adjuvant therapy should be applied for secondary prevention of metastatic relapse following resection of the primary tumor is based solely on statistical prognosis. For this reason, the direct identification of minimal residual cancer is of particular importance. The studies described below demonstrate the utility of immunocytochemical and molecular analysis in the diagnosis and characterization of minimal residual cancer. For the first time, these methods give access to this critical stage of tumor progression and also contribute to the development of new approaches to therapy aimed at preventing manifest metastasis.

## INTRODUCTION

Research into the molecular basis for tumor metastasis has resulted in the identification of numerous proteins that influence this critical property of tumor cells. The conditions necessary for the growth of epithelial cells that must be present in mesenchymal organs such as bone marrow are extensively unknown. The factors determining tumor cell dormancy, ie, the period from the dissemination of tumor cells until the appearance of clinically manifest metastases, during which time these cells appear to remain latent, are also unclear.

In contrast to solid metastases, isolated micrometastatic tumor cells are appropriate targets for intravenously applied therapeutics because of their accessibility for macromolecules and immunocompetent effector cells. From analyses of single cells, it would appear that most disseminated tumor cells do not proliferate.<sup>1</sup> For this reason, forms of treatment aimed at both dormant and proliferating cells are particularly interesting as adjuvant therapy.

## IMMUNOCYTOCHEMICAL DETECTION OF MICROMETASTASES

Whereas even micrometastatic tumor cell aggregates have been identified using conventional histopathological methods,<sup>2</sup> individual disseminated carcinoma cells in bone marrow have generally resisted clear cytological identification.<sup>3</sup> In the last 15 years, more sensitive immunocytochemical and molecular procedures have been developed that permit the identification of individual disseminated tumor cells in organs remote from the primary tumor on the basis of qualitative features.<sup>4-6</sup> Because some epithelial tumors tend to develop skeletal metastases, this relatively easily accessible compartment is particularly amenable to exploration by iliac crest aspiration. In addition, the medullary space is a site of particularly intensive cell exchange between circulating blood and mesenchymal interstitium.

The identification of individual disseminated tumor cells in cytological bone marrow preparations on the basis of cytomorphological criteria is extremely difficult and not very practical because of the lack of sensitivity. Experience to date has shown that cytokeratins (CKs) as integral components of the cytoskeleton of epithelial cells are stably expressed characteristics of tumor cells that can be clearly identified in individual carcinoma cells by means of specific monoclonal antibodies. Mucin-like tumor-associated cell membrane proteins, on the other hand, are less well suited for analysis on account of their expression through hematopoietic cells.<sup>3,7</sup> Immunohistochemical examination of bone marrow biopsies has shown that CK-positive tumor cells are mostly situated in interstitial tissue outside the sinusoidal vessels, which indicates that extravasation, one of the last processes in the metastasis cascade, has been successfully completed.<sup>8</sup> Although ectopic or illegitimate mRNA expression of cytokeratins in mesenchymal cells cannot be ruled out,<sup>9-11</sup> numerous negative findings in patients without identifiable malignant processes show that ectopic expression of cytokeratin proteins in bone marrow is very rarely identifiable by immunocytochemistry.<sup>3,5,7</sup> The time-consuming microscopic screening of large amounts of cytological samples could be facilitated in future through automated analysis of stained preparations using an image-analysis system (scanner). As an alternative, density gradients and antibody-charged magnetic particles can be used to enrich tumor cells over several logarithmic units.<sup>12</sup> However, the reproducibility of these enrichment techniques needs to be confirmed on clinical samples.

## MOLECULAR DETECTION OF MICROMETASTASES

In the last few years, molecular detection procedures have been used increasingly to identify disseminated tumor cells in organs remote from the primary tumor. In principle, cDNA of disseminated tumor cells can be amplified millions of times as a result of polymerase chain reaction (PCR), so that even the

smallest quantities of such tumor cells can be detected.<sup>6</sup> For this to happen, however, the tumor cell must have specific changes in its genome or mRNA expression pattern distinguishing it from the surrounding hematopoietic cells. Because solid tumors are notable for their extreme genetic heterogeneity, the detection of tumor-specific genomic changes at the level of a single cell is highly complex. Each individual primary tumor must be genotyped so that the corresponding patient-specific genetic lesion can be identified and the appropriate PCR probes (primers) selected.<sup>13,14</sup> This method is currently beyond the means of routine clinical diagnosis.

The detection of tumor-specific expressed mRNA species, on the other hand, appears to present fewer obstacles to widespread use of the PCR method.<sup>15,16</sup> The cell mRNA is transcribed into cDNA by means of reverse transcriptase (RT), and the cDNA is amplified in the subsequent PCR reaction. Although this method offers great potential for future clinical use, the specificity of tumor cell identification is currently the greatest barrier. Apart from the mRNA of the few tumor cells, the basic material for the PCR reaction also contains the mRNA of the large surplus of hematopoietic cells (in a ratio of  $10^6:1$ ), and a false-positive result can be obtained even with minimal expression of the corresponding marker mRNA in these hematopoietic cells. Although a series of RT-PCR assays has been developed to detect tumor cells in bone marrow, blood, and lymph nodes (Table 1), a number of reports have questioned the specificity of this method.<sup>9,11</sup> Some of the discrepancies could be clarified by methodical comparison in future ring tests for standardization of this extremely interesting detection technique. Apart from these methodological aspects, however, the prognostic significance of RT-PCR assays was demonstrated in some studies on smaller groups of patients with melanomas and various types of carcinomas.<sup>16-18</sup>

### PROGNOSTIC RELEVANCE OF MICROMETASTASES

Although the prognostic relevance of the immunocytochemical identification procedure has been confirmed in prospective clinical studies by various working groups (Table 2), doubts as to the value of the method have been expressed.<sup>4,32</sup> A closer analysis of these reports shows that the techniques used differ considerably in terms of reproducibility. This might also explain the different detection rates, ranging from 4% to 45%, that have been published, for example, for mammary carcinoma.<sup>4</sup> It is therefore necessary to define the critical variables in the immunocytochemical method<sup>7</sup> and to introduce standardization so as to allow a reproducible and more precise determination of the residual cancer cell count.<sup>33</sup>

Several studies have confirmed the result of the cytokeratin assay as a prognostic factor unaffected by conventional risk factors (Table 2). The observed correlation to the total relapse rate is of particular interest, as clinically manifest

**Table 1.** Detection of Disseminated Tumor Cells by Molecular Methods

<i>Tissue and Tumor Organ</i>	<i>mRNA/DNA Marker</i>
Bone marrow	
Breast tissue	CK-19, CEA
Colorectum	CEA, CK-19, CK-20
Stomach	CEA, CK-20
Pancreas	CEA
Prostate	PSA, CK-19
Head and neck	E48
Lymph nodes	
Breast tissue	CK-19, MUC1, $\beta$ -hCG
Cervix	HPV16, E6/E7
Colorectum	CEA, CK-19, CK-20, p53, and Ki-ras mutations
Prostate	PSA, PSM
Skin (melanoma)	Tyrosinase
Lung	p53, Ki-ras mutations
Pancreas	Ki-ras mutations
Head and neck	p53 mutations
Blood	
Breast tissue	CK-19, EGF-R, $\beta$ -hCG
Colorectum	Ki-ras mutations, CK-20
Pancreas	ras mutations
Prostate	PSA, PSM
Skin (melanoma)	Tyrosinase, p97, MUC18, MAGE-3
Lung	Microsatellite alterations
Stomach	CK-20
Liver	$\alpha$ -Fetoprotein
Head and neck	Microsatellite alterations
Liver	
Pancreas	Ki-ras mutations
Tumor resection margins	
Head and neck	p53 mutations

skeletal metastases are very rare in colon carcinoma. It would therefore appear that the presence of epithelial cells in bone marrow is more likely to be an indicator of early systemic tumor cell dissemination, the growth in bone marrow or other organs being determined by the milieu in question. In this context, it is interesting that the repeat identification over a 2-year period of tumor cells in the bone marrow of patients with operable gastric carcinoma had even greater prognostic value than the primary identification of disseminated cells when the primary tumor was resected.<sup>26</sup>

**Table 2.** Immunocytochemical Studies of the Prognostic Relevance of Disseminated Tumor Cells in Bone Marrow

Type of Tumor	Marker, Proteins	Detection Rate, %	Prognostic Value	Reference
Mammary carcinoma	CK	99/552 (36)	DFS, OS*	19
	EMA	189/350 (25)	DFS, OS	20
	EMA, TAG12, CK	38/100 (38)	DFS, OS*	21
	CK	18/49 (37)	DFS*	22
	TAG12	315/727 (43)	DFS, OS*	23
Colorectal carcinoma	CK-18	28/88 (32)	DFS*	24
Gastric carcinoma	CK-18	34/97 (35)	DFS	25
	CK-18	47/78 (60)	DFS	26
	CK-18	95/180 (53)	DFS*	27
Esophagus carcinoma	CK	37/90 (41)	DFS, OS	28
Bronchial carcinoma (NSCLC)	CK	17/43 (40)	DFS	29
	CK-18	83/139 (60)	DFS*, OS	30
	CK-18	15/39 (39)	DFS	31

\*Prognostic value as independent parameter confirmed through multivariate analysis. CK, cytokeratin; DFS, disease-free survival; EMA, epithelial membrane antigen; NSCLC, non-small-cell lung cancer; OS, overall survival; TAG, tumor-associated glycoprotein.

Circulating tumor cells can also be identified in peripheral blood. Repeat blood sampling is superior to sequential aspiration of bone marrow as a monitoring procedure. Recent examinations of patients with prostate and colorectal carcinoma and melanomas whose peripheral blood was examined perioperatively by molecular methods (see below) have shown that a temporary intraoperative dissemination of tumor cells in the bed of the vessels can occur.<sup>34-37</sup> Whether these cells reach and survive in secondary organs and there form manifest metastases is as yet unknown.

Early hematogenous tumor cell dissemination is the most common method of metastasis, but a second means, namely lymphogenous dissemination, is also of great clinical importance. Researchers have attempted to detect epithelial tumor cells in histopathologically unremarkable lymph nodes of patients with operable non-small-cell lung carcinoma (NSCLC). In patients with lung and esophageal cancer, antiepithelial antibody BerEp4, which homogeneously stained >90% of the primary carcinomas examined, has been used.<sup>38</sup> More recent experimental studies have shown that BerEp4 recognizes the 17-1A antigen.<sup>39</sup> In 15.2% of the studied carcinoma patients, individual tumor cells were identified with the monoclonal antibody BerEp4. Tumor cells were found in lymph nodes irrespective of the

**Table 3.** Phenotype of Cytokeratin-Positive Cells in Bone Marrow\*

Marker	Tumor Origin	Number of Patients With Marker <sup>+</sup> /CK <sup>-</sup> Cells, %
Growth factor receptors		
erbB2	Mamma	48/71 (67.6)
	Colorectum/stomach	14/50 (28.0)
Transferrin receptor	Mamma	17/59 (28.8)
	Colorectum	7/41 (41.1)
MHC class I antigens		
	Mamma	9/26 (34.6)
	Colon/stomach	37/65 (56.9)
Adhesion molecules		
EpCAM	Mamma	20/31 (64.5)
	Colorectum	4/6
ICAM-1	Lung (NSCLC)	13/31 (41.9)
Placoglobin	Lung (NSCLC)	4/12 (33.3)
	Colorectum	4/13 (30.8)
Proliferation-associated proteins		
Ki-67	Mamma	1/12 (8.3)
	Colorectum/stomach	0/21
p120	Mamma	1/11 (9.1)
	Colorectum/stomach	9/32 (28.1)

\*MHC, major histocompatibility complex; NSCLC, non-small-cell lung cancer.

established risk factors such as the T stage and degree of tumor differentiation. A correlation with the systemic dissemination in bone marrow could not be established, however. The autonomy of this lymph node assay as a prognostic aid with respect to the total relapse rate and overall survival was confirmed by multivariate analysis ( $P=.009$ ).<sup>39</sup> The results emphasize the importance of additional verification of lymph node dissemination. The clinical importance of this type of dissemination was recently confirmed in a similar manner for carcinoma of the esophagus<sup>40</sup> and colon.<sup>18</sup>

### PHENOTYPING OF MICROMETASTASES

Immunocytochemical double-staining methods have been developed for more precise characterization of disseminated tumor cells. In view of the malignant potential of CK-positive cells, a number of tumor-associated characteristics have been identified in this way (Table 3), including expression of Lewis Y blood group precursor antigens, overexpression of the erbB2 oncogene, and deficient expression of major histocompatibility complex (MHC) class I molecules, which, as restrictive elements, help T-lymphocyte-mediated tumor cell recognition.<sup>41,42</sup>



The malignant nature of CK-positive cells in bone marrow has been further confirmed through genomic analysis, which revealed several chromosomal alterations<sup>43,44</sup> and amplification of the *erbB2* gene in these cells.<sup>45</sup> Extensive cell culture experiments have also shown that cells disseminating into bone marrow have a time-limited proliferative potential at the time of primary diagnosis of the tumor.<sup>46</sup> It may therefore be assumed that at the primary stage, these cells do not yet proliferate autonomously but are in a latent state known as dormancy.<sup>1</sup> This observation is consistent with the rare frequency of *p53* mutations in CK-positive cells in bone marrow at the time of primary diagnosis.<sup>47</sup> The low proliferation rate could explain the relative resistance of micrometastatic tumor cells to chemotherapy<sup>48</sup> and would confirm the appropriateness of therapy strategies independent of the proliferation potential such as antibody therapy.<sup>49,50</sup>

The low frequency of epithelial tumor cells in bone marrow and their localization in such a well-supplied organ offer ideal conditions for elimination by immunocompetent cells. As the clinical history of epithelial tumor cells shows, however, micrometastatic tumor cells can be ignored for many years by the immune system. In this context, particular attention should be paid to the deficient expression of MHC class I molecules (Table 3). This low regulation could limit the prospects for immunogenetic treatment with tumor cell vaccines.<sup>51</sup> The tumor-killing immunological effect of antibody administration, on the other hand, is independent of MHC antigen expression.

## CONCLUSIONS

Although great progress has been made in oncological surgery in recent decades, minimal residual cancer significantly limits the current prospects for further improvements in lethality rates. Adjuvant therapy should therefore be standard with such residual disease. The statistical risk estimate based on conventional tumor classification gives only a relatively inaccurate assessment of the individual risk to a cancer patient. In the last 15 years, immunocytochemical and molecular analysis procedures have therefore been developed to diagnose and characterize minimal residual cancer. Extensive studies are currently in progress to standardize these processes with a view to ensuring reproducibility of the clinically relevant results.

As far as adjuvant therapy is concerned, success or failure can be assessed only after an observation period of several years. It is possible that control examinations of bone marrow and peripheral blood during therapy could provide indications as to the efficacy of the therapeutic approach used. The availability of a surrogate marker for monitoring is of great importance in the development of adjuvant therapy processes. Monitoring procedures of this type, which are not currently available for clinical therapy studies involving solid tumors, would be of consid-

erable value. Because of their easy accessibility, bone marrow or peripheral blood would be obvious contenders for monitoring controls and would make it possible for the first time for adjuvant therapies to be monitored at the subclinical stage of minimal residual cancer.

Our experience to date indicates that immunocytochemical or molecular monitoring of disseminated cells is possible in principle for individual patients,<sup>48,52</sup> although reproducible enrichment of the rare tumor cells would be desirable so as to reduce the chance factor in such longitudinal studies. In addition, long-term observations are required to establish whether the therapy-associated reduction in individual disseminated cells also correlates with improved prognosis. Tumor cells disseminated in bone marrow or peripheral blood, if they prove to be suitable as surrogate markers for early assessment of the efficacy of an adjuvant therapy, would have a significant influence on future oncological diagnosis and treatment. To achieve this goal, we have recently initiated a multicenter randomized trial on patients with nodal-positive breast cancer in which bone marrow and peripheral blood is being monitored to assess the effect of adjuvant chemotherapy and subsequent therapy with monoclonal antibody edrecolomab (Panorex) against EpCAM (Table 3) on micrometastatic disease.

## REFERENCES

1. Pantel K, Schlimok G, Braun S, et al. Differential expression of proliferation-associated molecules in individual micrometastatic carcinoma cells. *J Natl Cancer Inst* 85: 1419–1424, 1993.
2. Burkhardt R, Frisch B, Kettner G. The clinical study of micrometastatic cancer by bone biopsies. *Bull Cancer* 67:291–305, 1980.
3. Schlimok G, Funke I, Holzmann B, et al. Micrometastatic cancer cells in bone marrow: in vitro detection with anti-cytokeratin and in vivo labeling with anti-17-1A monoclonal antibodies. *Proc Natl Acad Sci U S A* 84:8672–8676, 1987.
4. Osborne MP, Rosen PP. Detection and management of bone marrow micrometastases in breast cancer. *Oncology* 8:25–36, 1994.
5. Pantel K, Riethmuller G. Micrometastasis detection and treatment with monoclonal antibodies. *Curr Top Microbiol Immunol* 213:1–18, 1996.
7. Pantel K, Schlimok G, Angstwurm M, et al. Methodological analysis of immunocytochemical screening for disseminated epithelial tumor cells in bone marrow. *J Hematother* 3:165–173, 1994.
8. Schlimok G. Mikrometastasen epithelialer Tumoren im Knochenmark: Immunzytochemischer Nachweis und in vivo Markierung mit Hilfe monoklonaler Antikörper. Habilitation 1988. Ludwig-Maximilians-Universität München, 1988.
9. Krismann M, Todt B, Schröder J, et al. Low specificity of cytokeratin 19 reverse transcriptase-polymerase chain reaction analyses for detection of hematogenous lung cancer dissemination. *J Clin Oncol* 13:2769–2775, 1995.
10. Traweek ST, Liu J, Battifora H. Keratin gene expression in non-epithelial tissues: detec-

- tion with polymerase chain reaction. *Am J Pathol* 142:1111–1118, 1993.
11. Zippelius A, Kufer P, Honold G, Riethmüller G. Limitations of reverse-transcriptase polymerase chain reaction analyses for detection of micrometastatic epithelial cancer cells in bone marrow. *J Clin Oncol* 15:2701–2708, 1997.
  12. Naume B, Borgen E, Beiske K, et al. Detection of isolated breast carcinoma cells in peripheral blood or bone marrow by immunomagnetic techniques. *J Hematother* 6:103–111, 1997.
  13. Hayashi N, Ito I, Yanagisawa A, et al. Genetic diagnosis of lymph-node metastasis in colorectal cancer. *Lancet* 345:1257–1259, 1995.
  14. Tada M, Omata M, Kawai SH, et al. Detection of ras gene mutations in Pancreatic Juice and Peripheral Blood of patients with pancreatic adenocarcinoma. *Cancer Res* 53:2472–2474, 1993.
  15. Neumaier M, Gerhard M, Wagener C. Diagnosis of micrometastases by the amplification of tissue-specific genes. *Gene* 159:43–47, 1995.
  16. Soeth E, Vogel I, Röder C, et al. Comparative analysis of bone marrow and venous blood isolates from gastrointestinal cancer patients for the detection of disseminated tumor cells using reverse transcription PCR. *Cancer Res* 57:3106–3110, 1997.
  17. Fields KK, Elfenbein GJ, Trudeau WL, Perkins JB, Janssen WE, Moscinski LC. Clinical significance of bone marrow metastases as detected using the polymerase chain reaction in patients with breast cancer undergoing high-dose chemotherapy and autologous bone marrow transplantation. *J Clin Oncol* 14:1868–1876, 1996.
  18. Liefers GJ, JA Cleton, van de Velde CJ, et al. Micrometastases and survival in stage II colorectal cancer. *N Engl J Med* 339:223–228, 1998.
  19. Braun S, Pantel K, Muller P, et al. Cytokeratin-positive bone marrow micrometastases and survival of breast cancer patients with stage I-III disease. *N Engl J Med* 342:525–533, 2000.
  20. Mansi JL, Gogas H, Bliss JM, Gazet JC, Berger U, Coombes RC. Outcome of primary-breast-cancer patients with micrometastases: a long-term follow-up study. *Lancet* 354:197–202, 1999.
  21. Harbeck N, Untch M, Pache L, Eiermann W. Tumor cell detection in the bone marrow of breast cancer patients at primary therapy: results of a 3-year median follow up. *Br J Cancer* 69:566–571, 1994.
  22. Cote RJ, Rosen PP, Lesser ML, Old MP. Prediction of early relapse in patients with operable breast cancer by detection of occult bone marrow micrometastases. *J Clin Oncol* 9:1749–1756, 1991.
  23. Diel IJ, Kaufmann M, Costa SD, et al. Micrometastatic breast cancer cells in bone marrow at primary surgery: prognostic value in comparison with nodal status. *J Natl Cancer Inst* 88:1652–1658, 1996.
  24. Lindemann F, Schlimok G, Dirschedl P, Witte J, Riethmüller G. Prognostic significance of micrometastatic tumor cells in bone marrow of colorectal cancer patients. *Lancet* 340:685–689, 1992.
  25. Schlimok G, Funke I, Pantel K, et al. Micrometastatic tumour cells in bone marrow of patients with gastric cancer: methodological aspects of detection and prognostic significance. *Eur J Cancer* 27:1461–1465, 1991.

26. Heiss MM, Allgayer H, Gruetzner KU, et al. Individual development and uPA-receptor expression of disseminated tumor cells in bone marrow: a reference to early systemic disease in solid cancer. *Nat Med* 1:1035–1039, 1995.
27. Jauch KW, Heiss MM, Gruetzner U, et al. Prognostic significance of bone marrow micrometastases in patients with gastric cancer. *J Clin Oncol* 14:1810–1817, 1996.
28. Thorban S, Roder JD, Pantel K, Siewert JR. Epithelial tumor cells in bone marrow of patients with pancreatic carcinoma detected by immunocytochemical staining. *Eur J Cancer* 32A:363–365, 1996.
29. Cote RJ, Beattie EJ, Chaiwun B, et al. Detection of occult bone marrow micrometastases in patients with operable lung carcinoma. *Ann Surg* 222:415–425, 1995.
30. Pantel K, Izbicki J, Passlick B, et al. Prognostic significance of isolated tumor cells in bone marrow of patients with non-small cell carcinomas without overt metastases. *Lancet* 347:649–653, 1996.
31. Ohgami A, Mitsudomi T, Sugio K, et al. Micrometastatic tumor cells in the bone marrow of patients with non-small cell lung cancer. *Ann Thorac Surg* 64:363–367, 1997.
32. Funke I, Schraut W. Meta-analyses of studies on bone marrow micrometastases: an independent prognostic impact remains to be substantiated. *J Clin Oncol* 16:557–566, 1998.
33. Borgen E, Naume B, Nesland JM, et al. Standardization of the immunocytochemical detection of cancer cells in BM and blood, I: establishment of objective criteria for the evaluation of immunostained cells. *Cytotherapy* 1:377–388, 1999.
34. Denis MG, Tessier M-H, Dréno B, Lustenberger P. Circulating micrometastases following oncological surgery. *Lancet* 347:913, 1996.
35. Eschwège P, Dumas F, Blanchet P, et al. Haematogenous dissemination of prostatic epithelial cells during radical prostatectomy. *Lancet* 346:1528–1530, 1995.
36. Hansen E, Wolff N, Knuechel R, Ruschoff J, Hofstaedter F, Taeger K. Tumor cells in blood shed from the surgical field. *Arch Surg* 130:387–393, 1995.
37. Weitz J, Kienle P, Lacroix J, et al. Dissemination of tumor cells in patients undergoing surgery for colorectal cancer. *Clin Cancer Res* 4:343–348, 1998.
38. Passlick B, Izbicki JR, Kubuschok B, et al. Immunohistochemical assessment of individual tumor cells in lymph nodes of patients with non-small cell lung cancer. *J Clin Oncol* 12:1827–1832, 1994.
39. Kubuschok B, Passlick B, Izbicki J, Thetter O, Pantel K. Disseminated tumor cells in lymph nodes as a determinant for survival in surgically resected non-small cell lung cancer. *J Clin Oncol* 17:19–24, 1999.
40. Izbicki JR, Hosch SB, Pichlmeier U, et al. Prognostic value of immunohistochemically identifiable tumor cells in lymph nodes of patients with completely resected esophageal cancer. *N Engl J Med* 337:1188–1194, 1997.
41. Hämmerling G, Maschek V, Sturmhöfel K, Momburg F. Regulation and functional role of MHC expression on tumors. In: Melchers F, ed. *Progress in Immunology*. Berlin, Germany: Springer, 1989, p. 1071–1078.
42. Wallich R, Bulbue N, Hämmerling GJ, Katzav S, Sagl S, Feldman M. Abrogation of metastatic properties of tumor cells by de novo expression of H-2K antigens following H-2 gene transfection. *Nature* 315:301–305, 1985.
43. Klein CA, Schmidt-Kittler O, Schradt JA, Pantel K, Speicher MR, Riehmüller G.

- Comparative genomic hybridization, loss of heterozygosity and DNA sequence analysis of single cells. *Proc Natl Acad Sci U S A* 96:4494–4499, 1999.
44. Dietmaier W, Hartmann A, Wallinger S, et al. Multiple mutation analysis in single tumor cells with improved whole genome amplification. *Am J Pathol* 154:83–95, 1999.
  45. Müller P, Weckermann D, Riethmüller G, Schlimok G. Detection of genetic alterations in micrometastatic cells in bone marrow of cancer patients by fluorescence in situ hybridization. *Cancer Genet Cytogenet* 88:8–16, 1996.
  46. Pantel K, Dickmanns A, Zippelius A, et al. Establishment of micrometastatic carcinoma cell lines: a novel source of tumor cell vaccines. *J Natl Cancer Inst* 87:1162–1168, 1995.
  47. Offner S, Schmaus W, Witter K, et al. p53 gene mutations are not required for early dissemination of cancer cells. *Proc Natl Acad Sci U S A* 96:6942–6946, 1999.
  48. Braun S, Kantenich C, Janni W, et al. Lack of effect of adjuvant chemotherapy on the elimination of single dormant cells in bone marrow of high risk breast cancer patients. *J Clin Oncol* 18:80–86, 2000.
  49. Riethmüller G, Holz E, Schlimok G, et al. Monoclonal antibody therapy for resected Dukes' C colorectal cancer: seven-year outcome of a multicenter randomized trial. *J Clin Oncol* 16:1788–1794, 1998.
  50. Braun S, Hepp F, Kantenich CRM, et al. Monoclonal antibody therapy with ercolomab in breast cancer patients: monitoring of elimination of disseminated cytokeratin-positive tumor cells in bone marrow. *Clin Cancer Res* 5:3999–4004, 1999.
  51. Pardoll DM. Cancer vaccines. *Immunol Today* 14:310–316, 1993.
  52. Pantel K, Enzmann T, Kollermann J, Caprano J, Riethmüller G, Kollermann MW. Immunocytochemical monitoring of micrometastatic disease: reduction of prostate cancer cells in bone marrow by androgen deprivation. *Int J Cancer* 71:521–525, 1997.

# **Enhanced Detection of Breast Cancer Cells Following CD34<sup>+</sup> Cell Selection Combined With Tumor Cell Purging**

**Amy A. Ross, Ginny Ofstein, Tamika Segura,  
Vu To, Peggie Mitsky, Bonnie Mills**

*Nexell Therapeutics Inc., Irvine, California*

## **ABSTRACT**

Numerous studies have documented the presence of contaminating tumor cells in autologous stem cell grafts (autoSCGs) from breast cancer patients. It is presently unclear if the infusion of tumor cells in autoSCGs contributes to posttransplant relapse. Two studies using standard immunocytochemical (ICC) assays found no correlation with tumor cell contamination of autoSCG and posttransplant relapse in patients with metastatic disease. However, recent reports on high-risk breast cancer patients (>9 positive nodes) concluded that the infusion of tumor-contaminated autoSCGs was significantly correlated with relapse and disease-free survival at median follow-up of 42 and 21 months. Thus, infusion of tumor-contaminated autoSCGs may be associated with an increased risk of relapse in this patient population. Nexell Therapeutics is currently investigating tumor depletion of peripheral blood stem cells (PBSCs) in high-risk/metastatic breast cancer patients by CD34<sup>+</sup> selection (Isolex 300i Magnetic Cell Selection System, version 1.12, for positive selection) and by CD34<sup>+</sup> selection followed by additional tumor purging (Isolex 300i system, version 2.0, with investigational software for positive/negative selection). Peripheral blood stem cell apheresis collections (not for infusion) were shipped to Nexell for cell selection (positive or positive/negative) and analysis of tumor contamination. To document tumor cell presence and evaluate removal, we developed a bead-enriched, double-immunostaining ICC (dsICC) assay that is capable of detecting 1 tumor cell in 50 million hematopoietic cells in PBSCs. Use of the dsICC assay allowed us to detect the presence or absence of purging antibodies on cytokeratin-positive tumor cells. Validation studies indicate that the dsICC procedure provides improved tumor detection capabilities over standard immunocytochemical assays. We analyzed the preselected apheresis product, CD34<sup>-</sup> (waste), and CD34<sup>+</sup> fractions from both selection procedures using standard ICC. The CD34<sup>-</sup> and CD34<sup>+</sup> fractions were

processed and analyzed using the dsICC procedure. Preliminary results from patient specimens enrolled in clinical trials ( $n = 10$ ) confirm that the dsICC assay is capable of enhanced detection of tumor contamination in CD34<sup>-</sup> and CD34<sup>+</sup> fractions from both selection procedures.

## INTRODUCTION

The clinical use of autologous stem cell transplantation (autoSCT) as a means of hematopoietic reconstitution following high-dose chemotherapy (HDC) for the treatment of breast cancer has heightened the concern about tumor contamination of the autoSCG. Several studies have indicated that mobilization regimens used in HDC/autoSCT can contribute to tumor contamination of PBSC collections.<sup>1-3</sup> Although no study to date has demonstrated that infused tumor cells in contaminated autoSCG grafts are solely responsible for posttransplant relapse, the presence of gene-marked, infused tumor cells at sites of disease relapse has been documented in 3 malignancies.<sup>4-6</sup>

No comparable data exist using gene-marking techniques in breast cancer patients treated with HDC/autoSCT. However, 2 studies using immunocytochemical techniques to document tumor contamination of autoSCG found no correlation with tumor cell infusion and posttransplant relapse.<sup>7,8</sup> In contrast, others have reported that tumor contamination of autologous grafts in breast cancer patients approaches or achieves statistical significance in predicting poor posttransplant outcome.<sup>9-11</sup> Two recent studies using ICC and reverse transcriptase-polymerase chain reaction (RT-PCR) assays reported significant correlation of tumor-contaminated autoSCGs with posttransplant relapse and disease-free survival.<sup>12,13</sup>

As the above-mentioned studies illustrate, it is unclear if the infusion of tumor cells contributes to posttransplant relapse in breast cancer patients treated with HDC/autoSCT. However, tumor contamination of autoSCGs can be reduced or eliminated by *in vitro* pharmacological methods,<sup>14,15</sup> negative tumor depletion,<sup>16</sup> or positive progenitor cell selection.<sup>17-19</sup> Whereas pharmacological methods have been shown to adversely affect the hematopoietic reconstituting abilities of hematopoietic progenitor cells, immunomagnetic cell selection methods have been shown to be safe and effective for hematopoietic reconstitution in breast cancer patients treated with HDC/autoSCT.<sup>17-19</sup> Thus, positive selection for CD34<sup>+</sup> hematopoietic progenitor cells provides effective tumor purging without compromising hematopoietic reconstitution.

In a recent study of high-risk stage II/III and metastatic stage IV breast cancer patients, Umiel *et al.*<sup>20</sup> used an enriched ICC assay to document tumor purging in CD34<sup>+</sup>-selected autologous PBSC grafts. This enhanced assay was capable of increasing tumor cell detection sensitivity ~50-fold over their standard ICC assay. Their preliminary findings on patient specimens indicated that tumor contami-

nation of the grafts may be substantially higher than previously reported.<sup>21-23</sup> Further, Umiel et al. reported that CD34<sup>+</sup> selection using the Isolex 300i Magnetic Cell Selection System reduced tumor cell contamination from 8 of 31 (26%) to 5 of 31 (16%) in paired PBSC specimens. However, tumor cell contamination was still present in some CD34<sup>+</sup>-selected specimens. In such instances, additional tumor purging may be accomplished by adding a negative tumor depletion step during CD34<sup>+</sup> cell selection with the Isolex 300i system.<sup>24,25</sup>

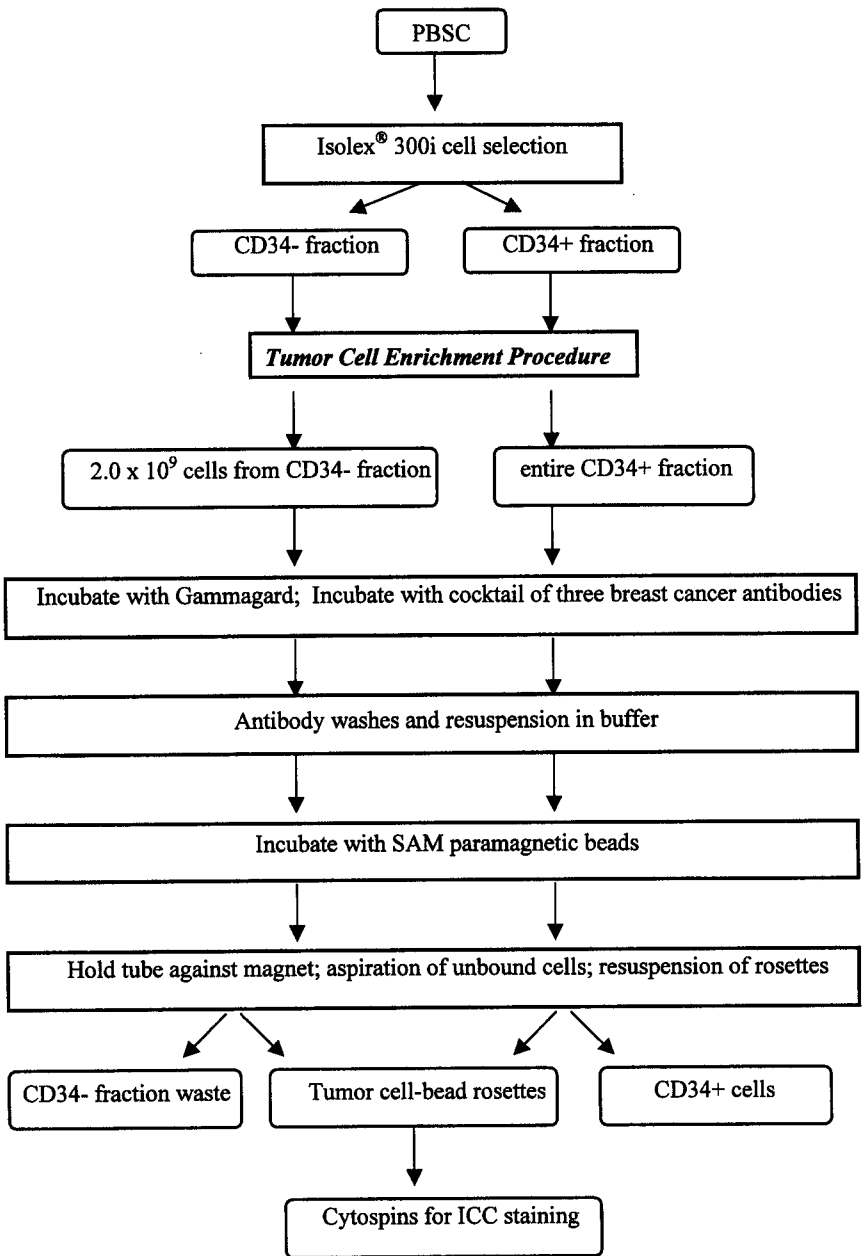
The purpose of this study was to evaluate the potential additional tumor purging capability of the Isolex 300i positive/negative procedure in breast cancer patient PBSC specimens. To assess tumor cell contamination, we developed a unique bead-enriched, double-staining immunocytochemical assay. This assay was used to compare tumor contamination of unmanipulated PBSCs, CD34<sup>-</sup> (waste), and CD34<sup>+</sup> fractions from breast cancer patient PBSC specimens processed with the Isolex 300i CD34 positive or positive/negative procedures.

## MATERIALS AND METHODS

### Tumor Cell Enrichment Procedure: Validation Experiments

Tumor cell seeding experiments were performed to validate the dsICC procedure (Figure 1). This procedure was modified from that originally developed by Brockmeyer et al.<sup>24</sup> Briefly, CAMA-1 cells (ATCC, Manassas, VA), a breast cancer tumor cell line maintained in culture, were added to mononuclear cells (MNCs) obtained from a normal donor. The percent of CAMA-1 cells seeded into the MNCs ranged from 0.0001% ( $1:1.0 \times 10^6$ ) to 0.000002% ( $1:5.0 \times 10^7$ ). Unseeded MNC specimens were used as the negative control. Two separate aliquots of MNCs were used for the dsICC procedure at each seeding level of CAMA-1 cells, one containing  $2.0 \times 10^9$  cells and the other containing  $1.0 \times 10^8$  cells, to approximate the expected number of cells in the CD34-negative and -positive fractions, respectively, obtained from breast cancer patient leukapheresis products. Cell suspensions were incubated separately with Immune Globulin Intravenous (Gammagard; Baxter Healthcare, Hyland Division, Glendale, CA) at room temperature for 15 minutes. The cells were then incubated with a cocktail of 3 murine anti-human breast cancer antibodies (9184, 9187, and 9189; Nexell Therapeutics, Irvine, CA) at a concentration of 2.5  $\mu\text{g}/\text{mL}$  each for 30 minutes, rotating to mix. The cells were washed twice with buffer to remove unbound antibody. Sheep anti-mouse (SAM)-coated paramagnetic beads (Dynabeads M-450, sheep anti-mouse immunoglobulin G; Dynal ASA, Oslo, Norway) were added at a ratio of 1 bead per 100 cells and incubated with the cells for 30 minutes to capture the tumor cells. While holding the tube against a magnet, unbound cells





**Figure 1.** Tumor enrichment procedure. ICC, immunocytochemical; PBSC, peripheral blood stem cell; SAM, sheep anti-mouse.

were aspirated. The tumor cell–bead rosettes from each fraction were resuspended in buffer, centrifuged onto positively charged slides, and stained using the Nexell Cytonex ICC kit, in conjunction with the double-staining method described below.

### **Tumor Cell Detection: Double-Staining of Tumor Cell–Bead Rosettes**

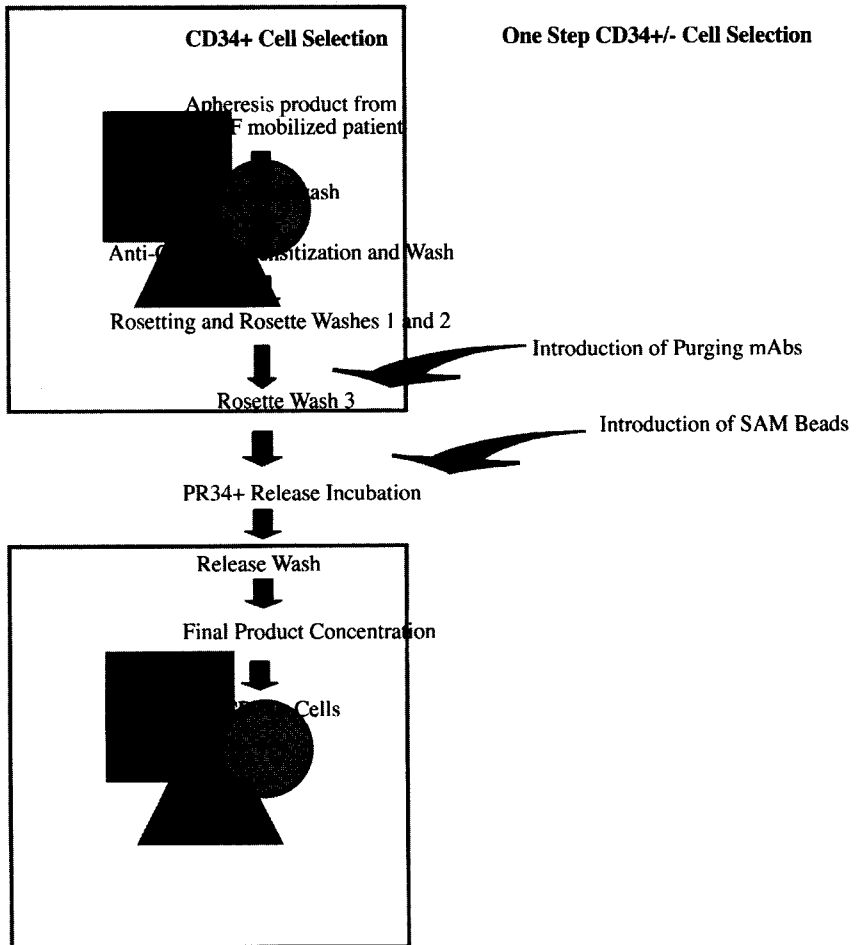
Twelve slides were prepared using tumor cell–bead rosettes obtained from all CAMA-1 cell MNC samples. Slides were stained using a double-staining method for dual detection of cytoplasmic cytokeratin antibodies and the membrane-bound breast cancer antibody cocktail (BCAC). Briefly, immunoperoxidase staining with 3,3-diaminobenzidine (DAB) was initially performed to develop a brown color reaction to the BCAC on the cell surface. Immunoalkaline phosphatase staining was subsequently performed on the cytospin preparation with the Cytonex ICC kit according to manufacturer's instructions.

### **Patient Specimens**

PBSCs were obtained by leukapheresis from female patients with high-risk (stage II with >10 positive nodes, stage III) or metastatic (stage IV) adenocarcinoma of the breast. Patients were assigned a Nexell patient study number and randomization assignment for either CD34 positive cell selection or CD34 positive/negative cell selection. All patients rendered their informed written consent under a US Food and Drug Administration (FDA)/institutional review board (IRB)–approved protocol. Patients were mobilized with either granulocyte colony-stimulating factor (G-CSF) alone (10  $\mu\text{g}/\text{kg}$  per day) or G-CSF in combination with chemotherapy (cyclophosphamide 4  $\text{g}/\text{m}^2$  followed by G-CSF 5  $\mu\text{g}/\text{kg}$  per day). Patients began apheresis collections when the mobilization regimen was deemed successful (>20 CD34 cells/ $\mu\text{L}$  peripheral blood). When sufficient cells for all clinical target collections (including an unselected back-up) had been obtained (>2.0  $\times 10^6$  CD34 cells/kg), an additional leukapheresis product was collected for this laboratory study. No cells from the additional leukapheresis product collected for this laboratory study were infused into patients.

### **Processing of Specimens: Cell Selection**

Patient PBSC collections were processed using the Isolex 300i Magnetic Cell Selection System (Nexell Therapeutics), either CD34 positive selection (version 1.12) or CD34 positive/negative selection (version 2.0 with investigational software), depending on the randomization assignment. The Isolex 300i for positive selection consists of a device, disposable set, and reagents that are designed, through a series of automated steps, to select CD34<sup>+</sup> cells from PBSCs.



**Figure 2.** Isoplex 300i magnetic cell selection procedures. mAb, monoclonal antibody; SAM, sheep anti-mouse.

Briefly, the procedure (Figure 2) involves a platelet wash, followed by anti-CD34 antibody sensitization and antibody wash. Sensitized cells are next incubated with SAM-coated paramagnetic beads, which bind to the murine CD34 antibody on the cell. Cell rosettes are washed to remove nontarget cells (negative fraction), which are diverted into a separate bag. A nonenzymatic stem cell releasing agent (PR34<sup>+</sup>) is used to separate the targeted CD34<sup>+</sup> cells from the paramagnetic beads. The released CD34<sup>+</sup> cells are collected in a separate sterile bag. The Isoplex 300i for positive/negative selection consists of all the components and steps described above plus 2 additional steps (Figure 1): (1) purging of breast tumor cells with the

use of 3 murine anti-breast cancer monoclonal antibodies (9184, 9187, and 9189; Nexell Therapeutics) and (2) the introduction of a second vial of SAM-coated paramagnetic beads just before the PR34<sup>+</sup> release step. This procedure allows for the simultaneous capture of CD34<sup>+</sup> cells and purging of breast cancer cells.<sup>25</sup>

### **Tumor Cell Detection: Standard Immunocytochemical Assay**

Aliquots from the preselection leukapheresis product, CD34<sup>+</sup> and CD34<sup>-</sup> fractions, were used for the preparation of cytopins onto positively charged microscope slides. One million cells were deposited on each slide in a volume of 0.1 mL. Six slides were prepared per fraction, for a total of 6 million cells per specimen. Slides were immunostained using the cocktail of anti-cytokeratin monoclonal antibodies in an immunokaline phosphatase assay (CytoneX ImmunoCytoChemistry Kit; Nexell Therapeutics) according to manufacturer's instructions.

### **Tumor Cell Enrichment Procedure: Patient Specimens**

Subsequent to the Isolex 300i cell selection process, the tumor cell enrichment procedure (Figure 2) was performed using  $2.0 \times 10^9$  cells of the CD34<sup>-</sup> fraction and the entire CD34<sup>+</sup> fraction as described in the tumor cell enrichment procedure validation experiments described above. Twelve slides were prepared using tumor cell-bead rosettes obtained from each CD34 cell fraction. Slides were stained using the double-staining method described above and viewed with a standard light microscope. Tumor cells were manually enumerated to obtain a semiquantitative result. A mean of 7 slides (range, 2 to 11 slides) were stained and enumerated per fraction for all patient samples.

## **RESULTS**

### **dsICC Validation Experiments**

Results of the validation experiments in which CAMA-1 cells were seeded at varying ranges into MNCs indicated that recovery of the CAMA-1 cells ranged from a low of 11% (seeding level of 0.000002% in  $2.0 \times 10^9$  MNCs) to a high of 60% (seeding level of 0.000002% in  $1.0 \times 10^8$  MNCs). Percent tumor cell recovery was a function of the number of tumor cells seeded and the number of MNCs processed. No stained cells were detected in the unseeded MNC samples. In a series of 4 replicate experiments at all cell-seeding concentrations, the upper limit of detection sensitivity of the dsICC assay was 1 tumor cell in  $5.0 \times 10^7$  MNCs. Thus, the dsICC assay increased tumor detection by 3 logs compared with standard ICC.

**Table 1.** Tumor Detection Results in Phase 2/3 Patient Specimens\*

Patient ID (Selection) and Diagnosis	PBSCs	Standard ICC Results		dsICC Results	
		CD34 <sup>-</sup> Fraction	CD34 <sup>+</sup> Fraction	CD34 <sup>-</sup> Fraction	CD34 <sup>+</sup> Fraction
33 (+/-) Stage II A	Negative	Negative	Negative	Positive (1 in $1.7 \times 10^8$ )	Negative
34 (+/-) Stage II B	Negative	Positive (1 in $5.5 \times 10^6$ )*	Negative	Positive (1 in $4.6 \times 10^8$ )	Negative
36 (+/-) Stage II B	Negative	Negative	Negative	Positive (1 in $9.2 \times 10^8$ )	Negative
37 (+/-) Stage II A	Negative	Negative	Negative	Positive (1 in $9.2 \times 10^8$ )	Negative
302 (+) Stage III	Negative	Positive (1 in $2.5 \times 10^6$ )	Negative	Positive (1 in $2.5 \times 10^8$ )	Positive (1 in $6.4 \times 10^7$ )
304 (+) Stage II	Negative	Positive (1 in $2.5 \times 10^6$ )	Negative	Positive (1 in $6.7 \times 10^7$ )	Negative
306 (+/-) Stage IV	Positive (1 in $4.5 \times 10^5$ )	Positive (1 in $2.5 \times 10^6$ )	Negative	Positive (1 in $1.4 \times 10^8$ )	Negative
402 (+) Stage IV	Negative	Positive (1 in $3.0 \times 10^6$ )	Negative	Positive (1 in $5.0 \times 10^8$ )	Negative
404 (+/-) Stage III	Negative	Negative	Negative	Negative	Negative
405 (+) Stage IV	Negative	Positive (1 in $5.0 \times 10^6$ )	Negative	Positive (1 in $8.3 \times 10^8$ )	Negative

\*Tumor frequency in parentheses. dsICC, double-immunostaining immunocytochemical; ICC, immunocytochemical.

### Patient Specimens

Ten patient PBSC products from phase 2/3 studies were analyzed (Table 1). Four patient specimens were selected with the Isolex 300i using the CD34 positive procedure, and 6 were processed using the CD34 positive/negative procedure, using investigational software. Five patients in the study were diagnosed with stage II breast cancer, 2 with stage III, and 3 with stage IV. Using the standard ICC assay, 1 of 10 PBSC specimens showed immunostained tumor cells. Six of the 10 CD34<sup>-</sup> fractions were found to be positive for tumor cells as determined by standard ICC, compared with 9 of 10 when using the dsICC (tumor cell counts ranged from 1 in  $1.67 \times 10^7$  to 1 in  $9.2 \times 10^8$  hematopoietic cells). None of the CD34<sup>+</sup> fractions was positive for immunostained tumor cells using the standard ICC assay, whereas tumor was detected in 1 of 10 of the CD34<sup>+</sup> specimens when the dsICC was used for detection. This specimen was obtained from a patient with stage III disease whose PBSC product was processed with the CD34 positive procedure.

## DISCUSSION

Although the clinical relevance of infusion of breast cancer cells in the HDC/autoSCT setting remains to be elucidated, the fact remains that many autoSCGs contain contaminating tumor cells.<sup>1-3,7-16,20-23</sup> Prospective studies analyzing the clinical correlation of the infusion of tumor cells with outcome in the breast cancer HDC/autoSCT setting have provided conflicting results. Using standard ICC techniques, 2 studies showed no correlation of tumor contamination of autoSCG with posttransplant outcome in stage IV patients<sup>8</sup> or high-risk stage II/III and metastatic stage IV patients.<sup>7</sup> In contrast, Solano et al.<sup>13</sup> recently used a similar standard ICC assay to analyze PBSC collections from 52 high-risk stage II patients (>9 positive axillary nodes). At median posttransplant follow-up of 42 months, median disease-free survival was better in the patients who received a tumor-free graft than in those who received a tumor-contaminated graft ( $P=.002$ ). Multivariate analysis concluded that tumor contamination of the PBSC product was the only prognostic predictor of posttransplant relapse ( $P<.01$ ). Vannucchi et al.<sup>12</sup> used an RT-PCR assay with reported tumor detection sensitivity greater than standard ICC techniques to analyze PBSC grafts from 33 stage II/III breast cancer patients. They reported that there was a trend toward longer relapse-free survival ( $P=.053$ ) posttransplant in patients who received a tumor-negative graft. In a subset of 4 patients with RT-PCR–positive PBSC specimens, the infused grafts became RT-PCR–negative after CD34<sup>+</sup> selection.

As illustrated above, highly sensitive assays that detect low numbers of tumor cells are crucial in investigating the role that the infusion of tumor cells may play in the HDC/autoSCT treatment setting. Several recent studies have employed tumor-enrichment technology to increase the detection sensitivity of tumor cells in breast cancer autoSCGs.<sup>20,24,26,27</sup> Collectively, these studies have demonstrated that tumor contamination of breast cancer PBSC collections is more prevalent than that reported by studies using standard tumor detection techniques. Umiel et al.<sup>20</sup> used a tumor enrichment assay to evaluate PBSC specimens and CD34<sup>+</sup>-selected specimens from breast cancer patients with high-risk stage II/III and metastatic stage IV disease. Their results indicate that the tumor-enriched assay detected a greater level of tumor contamination of PBSC specimens (86%) than did the standard ICC assay (7%).

Taken together, these studies suggest that tumor contamination of autoSCGs is more prevalent than previously appreciated, and that CD34<sup>+</sup> cell selection procedures alone may not remove all tumor cells from the grafts. Laboratory experiments using tumor cell–seeded specimens have indicated that the inclusion of an additional tumor-purging step to the existing CD34<sup>+</sup> cell selection technology increases the depletion of contaminating tumor cells.<sup>25,28</sup> For these reasons, we are conducting studies directly comparing the tumor-purging capability of the Isolex

300i CD34 positive selection procedure versus the Isoplex 300i positive/negative (investigational software) procedure.

To more accurately analyze the levels of tumor contamination in these PBSC specimens, we developed a novel double-staining ICC assay using tumor-enriched cell samples. This dsICC assay demonstrated increased sensitivity of tumor cell detection over our standard nonenriched ICC assay. In tumor cell-seeding experiments, we were able to document a 3-log increase in tumor cell detection, up to 1 tumor cell in 50 million PBSCs. Further, the double-immunostaining assay allowed for simultaneous microscopic evaluation of the binding of breast cancer purging antibodies on cytokeratin-positive cells. Thus, the combination of the bead-enrichment methods with the dsICC assay provided enhanced detection and microscopic visualization of extremely low numbers of seeded tumor cells in PBSC specimens (1 in  $5.0 \times 10^7$  hematopoietic cells).

Our preliminary analyses of 10 patient specimens indicate that the bead-enriched dsICC assay provided enhanced detection of contaminating tumor cells. Eight of 10 PBSC patient specimens that were deemed to be tumor-negative using the standard ICC assay proved to be tumor-positive with the dsICC assay of the CD34<sup>-</sup> fraction. None of the 10 CD34<sup>+</sup> fractions analyzed by standard ICC analysis showed immunostained tumor cells; however, using the dsICC assay, 1 of the CD34<sup>+</sup> fractions (processed with the CD34 positive selection protocol) from a patient with stage III breast cancer showed double-immunostained tumor cells. These preliminary data suggest that the dsICC assay is more sensitive than the standard ICC assay in detecting low numbers of tumor cells in patient PBSC collections and, potentially, in CD34<sup>+</sup>-selected fractions from patients with breast cancer.

In conclusion, there is concern that tumor contamination of breast cancer autoSCGs may contribute to poor posttransplant clinical outcome. As novel therapies evolve that result in additional in vivo tumoricidal effects (eg, Herceptin therapy), and as HDC/autoSCT protocols are refined to target those patients who might derive greater benefit,<sup>29</sup> it is possible that the infusion of tumor cells may take on added significance. Our preliminary studies indicate that tumor contamination of PBSCs can be more accurately detected using our dsICC enhanced assay, and that tumor cell removal of contaminated products is feasible using the approved Isoplex 300i CD34 positive selection procedure and the investigational Isoplex 300i CD34 positive/negative selection procedure. Clinical studies are ongoing to address this issue.

## REFERENCES

1. Brugger W, Bross KJ, Glatt M, Weber F, Mertelsmann R, Kanz L. Mobilization of tumor cells and hematopoietic progenitor cells into peripheral blood of patients with solid tumors. *Blood* 83:636-640, 1994.

2. Passos-Coelho JL, Ross AA, et al. Absence of breast cancer cells in a single-day peripheral blood progenitor cell collection after priming with cyclophosphamide and granulocyte-macrophage colony-stimulating factor. *Blood* 85:1138–1143, 1995.
3. Passos-Coelho JL, Ross AA, Kahn DJ, et al. Similar breast cancer cell contamination of single-day peripheral-blood progenitor-cell collections obtained after priming with hematopoietic growth factor alone or after cyclophosphamide followed by growth factor. *J Clin Oncol* 14:2569–2575, 1996.
4. Brenner MK, Rill DR, Moen RC, et al. Gene-marking to trace origin of relapse after autologous bone-marrow transplantation. *Lancet* 341:85–86, 1993.
5. Deisseroth AB, Zu Z, Claxton D, et al. Genetic marking shows that Ph<sup>+</sup> cells present in autologous transplants of chronic myelogenous leukemia (CML) contribute to relapse after autologous bone marrow in CML. *Blood* 83:3068–3076, 1994.
6. Rill DR, Santana VM, Roberts WM, et al. Direct demonstration that autologous bone marrow transplantation for solid tumors can return a multiplicity of tumorigenic cells. *Blood* 84:380–383, 1994.
7. Weaver CH, Moss T, Schwartzberg LS, et al. High-dose chemotherapy in patients with breast cancer: evaluation of infusing peripheral blood stem cells containing occult tumor cells. *Bone Marrow Transplant* 21:1117–1124, 1998.
8. Cooper BW, Moss TJ, Ross AA, Ybanez J, Lazarus HM. Occult tumor contamination of hematopoietic stem-cell products does not affect clinical outcome of autologous transplantation in patients with metastatic breast cancer. *J Clin Oncol* 16:3509–3517, 1998.
9. Fields KK, Elfenbein GJ, Trudeau WL, Perkins JB, Janssen WE, Moscinski LC. Clinical significance of bone marrow metastases as detected using the polymerase chain reaction in patients with breast cancer undergoing high-dose chemotherapy and autologous bone marrow transplantation. *J Clin Oncol* 14:1868–1876, 1996.
10. Vredenburgh JJ, Silva O, Broadwater G, et al. The significance of tumor contamination in the bone marrow from high-risk primary breast cancer patients treated with high-dose chemotherapy and hematopoietic support. *Biol Blood Marrow Transplant* 3:91–97, 1997.
11. Brockstein BE, Ross AA, Moss TJ, Kahn DG, Hollingsworth K, Williams SF. Tumor cell contamination of bone marrow harvests products: clinical consequences in a cohort of advanced-stage breast cancer patients undergoing high-dose chemotherapy. *J Hematother* 5:605–616, 1996.
12. Vannucchi AM, Bosi A, Glinz S, et al. Evaluation of breast tumor cell contamination in the bone marrow and leukapheresis collections by RT-PCR for cytokeratin-19 mRNA. *Br J Haematol* 103:610–617, 1998.
13. Solano C, Badia B, Benet I, et al. Prognostic significance of contaminating tumor cells in apheresis in high-risk breast cancer patients treated with peripheral blood stem cell transplantation [abstract]. *Proc Am Soc Clin Oncol* 19:122a, 2000.
14. Shpall EJ, Jones RB, Bast RC Jr, et al. 4-Hydroperoxycyclophosphamide purging of breast cancer from the mononuclear cell fraction of bone marrow in patients receiving high-dose chemotherapy and autologous marrow support: a phase I trial. *J Clin Oncol* 9:85–93, 1991.



15. Passos-Coelho J, Ross AA, Davis JM, et al. Bone marrow micrometastases in chemotherapy-responsive advanced breast cancer: effect of *ex vivo* purging with 4-hydroperoxycyclophosphamide. *Cancer Res* 54:2366–2371, 1994.
16. Pedrazzoli P, Lanza A, Battaglia M, et al. Negative immunomagnetic purging of peripheral blood stem cell contamination while not affecting hematopoietic recovery. *Cancer* 88:2758–2765, 2000.
17. Shpall EJ, Jones RB, Bearman SI, et al. Transplantation of enriched CD34-positive autologous marrow into breast cancer patients following high-dose chemotherapy: influence of CD34-positive peripheral-blood progenitors and growth factors on engraftment. *J Clin Oncol* 2: 28–36, 1994.
18. Handgretinger R, Greil J, Schurmann U, et al. Positive selection and transplantation of peripheral CD34<sup>+</sup> progenitor cells: feasibility and purging efficacy in pediatric patients with neuroblastoma. *J Hematother* 6:235–242, 1997.
19. Hohaus S, Pförsich M, Murea S, et al. Immunomagnetic selection of CD34<sup>+</sup> peripheral blood stem cells for autografting in patients with breast cancer. *Br J Haematol* 97:881–888, 1997.
20. Umiel T, Prilutskaya M, Nguyen NH, et al. Breast tumor contamination of peripheral blood stem cell harvests: increased sensitivity of detection using immunomagnetic enrichment. *J Hematotherapy Stem Cell Res* 9:895–904, 2000.
21. Sharp JG, Kessinger A, Vaughan WP, et al. Detection and clinical significance of minimal tumor cell contamination of peripheral stem cell harvests. *Int J Cell Cloning* 10:92–94, 1992.
22. Ross AA, Cooper BW, Lazarus HM, et al. Detection and viability of tumor cells in peripheral blood stem cell collections from breast cancer patients using immunocytochemical and clonogenic assay techniques. *Blood* 9:2605–2610, 1993.
23. Franklin WA, Shpall EJ, Archer P, et al. Immunocytochemical detection of breast cancer cells in marrow and peripheral blood of patients undergoing high dose chemotherapy with autologous stem cell support. *Breast Cancer Res Treat* 41:1–13, 1996.
24. Brockmeyer C, Moss TJ, Prilutskaya M, Mansour V, Burgess J, Kunkel LA. Incidence of breast cancer cells in the CD34 negative fraction of PBSC harvests after Isolex separation [abstract]. *Bone Marrow Transplant* 19 (Suppl 1):S40, 1997.
25. Preti RA, Nadasi S, Murawski J, McMannis J, Karandish S, Pecora AL. Single step positive/negative purging for breast cancer and T lymphocyte depletion using the Baxter Isolex 300i magnetic cell separator (Isolex 300I) [abstract]. *Blood* 90 (Suppl 2):346b, 1997.
26. Ross AA, Layton TJ, Stenzel-Johnson P, et al. Enrichment of tumor cells from autologous transplantation grafts from breast cancer patients. In: Dicke KA, Keating A, eds. *Autologous Marrow and Blood Transplantation: Proceedings of the Ninth International Symposium, Arlington, Texas*. Charlottesville, VA: Carden Jennings, 1999, p. 521–528.
27. Shammo JM, Smith SL, Bennett MV, et al. Use of a tumor-cell enrichment column for the enhanced detection of minimal residual disease in the BM or apheresis peripheral blood transplant products of breast-cancer patients. *Cytherapy* 1:367–376, 1999.
28. Schaeffer A, Yacob D, Guillermo R, Deans R. A protocol for additional tumor purging

- used simultaneously with CD34<sup>+</sup> cell selection using the Isolex 300i. *J Hematother* 6:396–401, 1997.
29. Nieto Y, Cagnoni PJ, Nawaz S, et al. Evaluation of the predictive value of Her-2/neu over-expression and p53 mutations in high-risk primary breast cancer patients treated with high-dose chemotherapy and autologous stem cell transplantation. *J Clin Oncol* 18:2070–2080, 2000.

# **Monitoring of Minimal Residual Disease in Breast Cancer Patients Treated With Adjuvant High-Dose Therapy and Stem Cell Support**

**Gunnar Kvalheim, Jahn M. Nesland, Hilde Sommer, Gunn Anker,  
Helge Haarstad, Arne Kolstad, Bjørn Erikstein**

*Department of Medical Oncology and Radiotherapy (G.K., B.E.),  
Department of Pathology (J.M.N.), the Norwegian Radium Hospital, Oslo;  
Department of Medical Oncology and Radiotherapy (H.S.), Ullevål Hospital,  
Oslo; Department of Medical Oncology and Radiotherapy (G.A.), Haukeland  
Hospital, Haukeland; Department of Medical Oncology and Radiotherapy  
(H.H.), University Hospital, Trondheim; Department of Medical Oncology  
and Radiotherapy (A.K.), University Hospital, Tromsø, Norway*

## **ABSTRACT**

In Scandinavia, 525 high-risk stage II breast cancer patients with an expected 5-year relapse-free survival of 30% or less were treated with 9 cycles of dose-escalating chemotherapy (FEC [fluorouracil, epirubicin, and cyclophosphamide] with granulocyte colony-stimulating factor (G-CSF) support ( $n = 251$ ) or 3 cycles of FEC plus CTCb (cyclophosphamide, thiotepa, and carboplatin) with peripheral blood progenitor cell (PBPC) support ( $n = 274$ ). In patients entering the study in Norway, micrometastatic detection was performed in bone marrow and blood before treatment and in PBPCs, bone marrow, and blood after treatment. Of the 67 patients given high-dose therapy with stem cell support, 23 of 67 patients had cytokeratin-positive (CK<sup>+</sup>) cells in the bone marrow at diagnosis. Despite tumor reduction with 3 cycles of chemotherapy, 15 patients (22%) had tumor cells in their PBPC products. Six to 12 months after treatment, patients were tested for micrometastases in the bone marrow. Among 58 patients given high-dose therapy, 11 had persistent CK<sup>+</sup> cells, and 5 became positive after high-dose therapy. With a median observation time of 30 months, 21 of 67 patients in Norway given high-dose therapy with stem cell support have relapsed. When the presence of CK<sup>+</sup> cells in the bone marrow and PBPCs was correlated with the outcome of the patients, it was found that 11 of the 21 relapsing patients and 12 of the 46 patients still in complete remission (CR) had CK<sup>+</sup> cells in the bone marrow at diagnosis. CK<sup>+</sup> cells were found in 38% of the PBPC products of relapsing patients, and 15% of PBPC

products of patients in CR were contaminated. Of the 58 patients who underwent a follow-up bone marrow examination after therapy, 63% of the relapsing patients vs. 5% of the patients in CR had CK<sup>+</sup> cells. The data indicate that early relapse is associated with circulating tumor cells that are resistant to high-dose therapy.

## INTRODUCTION

Sensitive methods developed to detect minimal residual disease before and after therapy have brought new insights into the biologic behavior of hematopoietic malignancies treated with standard or high-dose chemotherapy. The polymerase chain reaction (PCR) is based on an *in vitro* enzymatic amplification of a specific target DNA segment, resulting in a highly specific enrichment of the sequence of interest. Cloning the breakpoints of specific translocations makes it possible to use amplification by PCR to detect tumor cells containing the translocation. In chronic myeloid leukemia (CML) patients, PCR of BCR-ABL transcripts is a reliable method to detect minimal residual disease. Quantification of BCR-ABL transcripts using the real-time PCR method enables increases or decreases in the PCR signal to be measured. After bone marrow transplantation for CML, an increasing PCR signal predicts relapse several months before it is evident by morphologic examination of the bone marrow.<sup>1</sup> Such a method is also used to measure the effect of donor T-cell infusions on CML patients who relapse after transplantation. However, the use of PCR requires that the malignant cells carry a clonal somatic mutation in their genome that is absent in normal cells. Unfortunately, solid tumors such as breast cancers do not meet these requirements. In spite of this, several groups have developed reverse transcription–polymerase chain reaction (RT-PCR) assays that screen for carcinoma-specific mRNA expression in mesenchymal tissues such as bone marrow and blood. RT-PCR assays for cytokeratin 19 have been reported to specifically detect breast cancer cells in bone marrow. However, Zippelius et al.<sup>2</sup> found a major limitation of RT-PCR methods in detecting micrometastatic epithelial cancer cells in bone marrow due to illegitimate transcription of tumor-associated or epithelial-specific genes in blood cells. Because 7 of 8 markers used for PCR detection could be detected in a high number of bone marrow samples from normal control subjects, the results previously reported are questionable. Recently, Slade et al.<sup>3</sup> developed a quantitative PCR method for the detection of micrometastases in patients with breast cancer. It remains to be seen if such a procedure can be used in the clinic.

The presence of minimal residual disease in bone marrow has frequently been studied in breast cancer patients at diagnosis.<sup>4–8</sup> Depending on the monoclonal antibodies used in conjunction with immunocytochemistry, the frequency of bone marrow positivity in patients will differ. Because the antibodies are not tumor-specific, cross-reaction with normal hematopoietic cells<sup>9</sup> leads to false-positive

samples. In an ongoing study at our hospital employing anticytokeratin monoclonal antibodies (mAbs) AE1/AE3 or A45-B/B3 and immunocytochemistry, 26.6% of the bone marrow samples from 257 breast cancer patients tested were anticytokeratin-positive. Among these samples, 5.4% of the isotype controls stained positive, suggesting that unspecific binding of anticytokeratin mAbs to nonepithelial cells occurred.<sup>10</sup> Based on this experience, we now always employ morphological evaluation and negative controls when using immunocytochemistry.

Although immunocytochemical methods need to be standardized, several large breast cancer studies indicated that detection of micrometastases in the bone marrow at diagnosis was associated with an increased risk of systemic relapse.<sup>4-6</sup> In our hospital, we are currently investigating the presence of micrometastases in bone marrow and blood from patients with operable breast cancer. So far, 523 of 900 patient samples have been evaluated (Naume B, Borgen E, Kvalheim G, *et al.* Detection of isolated tumor cells in bone marrow in localised breast cancer [abstract]. 2nd International Symposium on Minimal Residual Cancer, 1998). Among 297 lymph node-negative (LN<sup>-</sup>) breast cancers, 12.4% had CK<sup>+</sup> tumor cells in their bone marrow, whereas 36% of the 226 patients with LN<sup>+</sup> tumors were CK<sup>+</sup>. Because of the short observation time, it remains to be seen if our study confirms the data of other investigators.

The sensitivity and reliability of immunocytochemical techniques used to detect isolated epithelial cells in bone marrow and blood is restricted by the low number of tumor cells found on each slide. We recently reported our clinical experience after enrichment of tumor cells from large numbers of mononuclear hematopoietic cells. CD45 antigen-expressing cells were removed from samples with anti-CD45-conjugated immunomagnetic beads, and the remaining cells were examined for the presence of tumor cells by immunocytochemistry using anti-CK mAbs. A mean 4.1-fold higher number of positive cells was detected with the CD45 depletion procedure than with direct cytospin.<sup>11</sup> In the present study, all samples underwent CD45-bead depletion before immunocytochemistry.

Recently, it was reported that the presence of CK<sup>+</sup> cells in the bone marrow after adjuvant chemotherapy is associated with a poor prognosis.<sup>12</sup> It is not known if the same applies to patients with breast cancer given adjuvant high-dose therapy and stem cell support. Our data indicate that the presence of CK<sup>+</sup> cells both at diagnosis and after therapy is associated with disease relapse.

## METHODS AND MATERIALS

### Patients

Of the 525 high-risk breast cancer patients treated in Scandinavia either with 9 cycles of dose escalation of FEC plus G-CSF or with 3 cycles of FEC plus CTCb

with PBPC support (protocol SBG 9401, chaired by J. Bergh, Sweden), 126 underwent bone marrow examination before and after therapy. Only patients given high-dose therapy with stem cell support are reported in the present study ( $n = 67$ ).

### **Preparation of Cells and Immunomagnetic Depletion of CD45<sup>+</sup> Cells**

After patients gave informed consent, 20 mL bone marrow was aspirated from both sides of the posterior iliac crest at diagnosis and 6, 12, and 24 months after therapy. Mononuclear bone marrow cells were prepared with the use of Lymphoprep (Nycomed, Norway). The method for immunomagnetic depletion of CD45<sup>+</sup> cells has been described previously.<sup>11</sup> The desired amount of directly coated anti-CD45 Dynabeads (Dynal A/S, Norway) was added to the mononuclear bone marrow cell suspension or the PBPC. After 30 minutes of incubation, the bead/CD45<sup>+</sup> cell complexes were formed. By placing a flat cobalt samarium magnet to the wall of the tubes, the rosettes were fixed to the plastic wall, and unbound cells containing the tumor cells could be removed and transferred into a new tube. After repeating the procedure twice to remove CD45<sup>+</sup> cells, the remaining cells were centrifuged on cytospin slides.

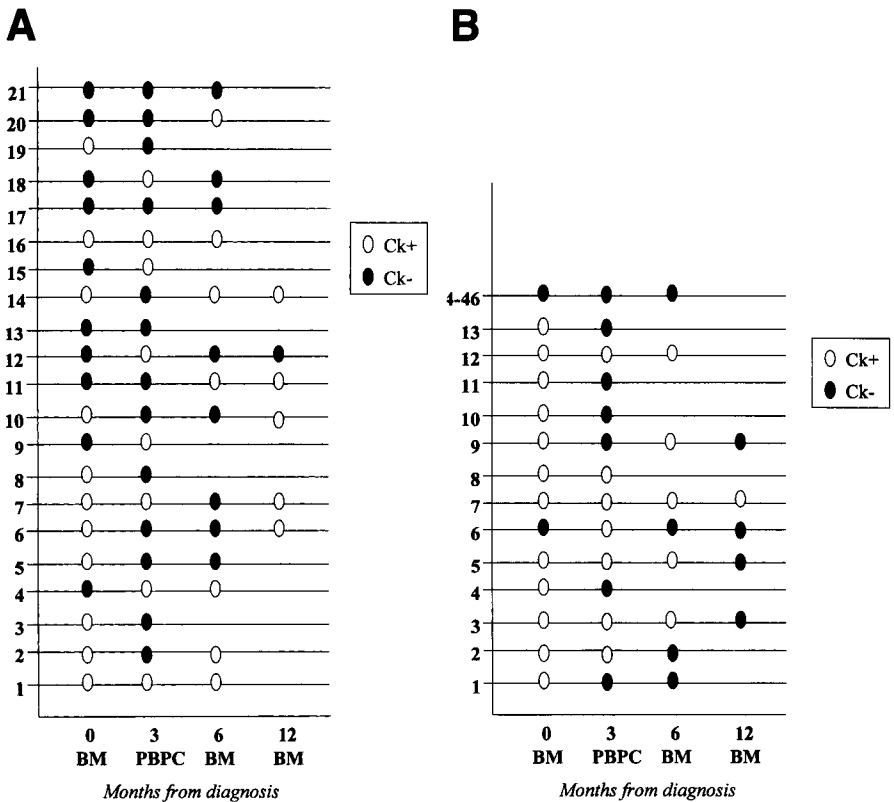
### **Immunocytochemistry**

In addition to the cytospin preparation of the remaining cells after CD45 depletion, 4 slides containing  $2 \times 10^6$  mononuclear cells from unmanipulated blood or bone marrow were prepared from each patient.<sup>4-6</sup> The slides were air-dried overnight and fixed for 10 minutes in acetone. The following day, slides were incubated for 30 minutes in a moist chamber with a 1:20 dilution of the anti-cytokeratin primary antibodies AE1 and AE3 (Signet Laboratories, Dedham, MA) followed by washing twice with Tris-HCL. As a second step, a polyclonal rabbit anti-mouse antibody (Dako, Glostrup, Denmark) was added, and after 30 minutes of incubation, the cells were washed twice with Tris-HCL. Finally, preformed complexes of alkaline phosphatase monoclonal mouse and anti-alkaline phosphatase (Dako) were added for 30 minutes. After washing twice with Tris-HCL, the color reaction of antibody-binding cells was given by 10 minutes of incubation with 0.26% New Fuchsin solution (Aldrich Chemical, Milwaukee, WI). In addition, all slides were counterstained with hematoxylin for the cellular morphology. As a negative control, 1 slide was incubated first with isotype-matched mouse myeloma immunoglobulins and, thereafter, with the APAAP technique as described above. The stained slides were mounted in glycerin-gelatin and examined under a light microscope by an experienced pathologist. Only cells that had the antibody-binding color reaction and epithelial cell morphology were scored as tumor cells.

## RESULTS

Incidence of CK<sup>+</sup> Cells in Bone Marrow and PBPC

Of the 274 high-risk breast cancer patients treated with 3 cycles of FEC plus CTCb with PBPC support, 67 underwent bone marrow examination at diagnosis, and 58 of those patients were reexamined 6–24 months after therapy. Of the 67 patients given high-dose therapy with stem cell support, 23 patients had CK<sup>+</sup> cells in the bone marrow at diagnosis (Figure 1A and 1B). Despite tumor-reductive therapy with 3 cycles of chemotherapy, 15 patients (22%) had tumor cells in their PBPC products. This indicates that mobilization of tumor cells occurs at the same time as that of hematopoietic progenitor cells. Six to 12 months after treatment, patients were tested for the presence of micrometastases in bone marrow. Among



**Figure 1.** A, Individual cytokeratin-positive (CK<sup>+</sup>) results of 21 breast cancer patients who relapsed after high-dose therapy. B, Individual CK<sup>+</sup> results of 46 breast cancer patients in complete remission with median observation time of 30 months. BM, bone marrow; PBPC, peripheral blood progenitor cells.

58 patients, 11 had persistent CK<sup>+</sup> cells, and 5 became positive after high-dose therapy.

### CK<sup>+</sup> Cells and Clinical Outcome

With a median observation time of 30 months, 21 of 67 patients given high-dose therapy with stem cell support in Norway have relapsed (Table 1). When the presence of CK<sup>+</sup> cells in the bone marrow and PBPC was correlated with outcome, it was found that 11 of the 21 relapsing patients (52%) and 12 of the 46 patients (26%) still in complete remission (CR) had CK<sup>+</sup> cells in the bone marrow at diagnosis. Among the relapsing patients, CK<sup>+</sup> cells were found in 8 of 21 PBPC products (38%), whereas of the patients in CR, 7 of 46 PBPC products (15%) were contaminated. The CD34<sup>+</sup> cell-enriched population was used in 30 of the 67 patients. Except for 1 patient with persistent CK<sup>+</sup> cells after enrichment, the remaining purified CD34<sup>+</sup> cell grafts were free of CK<sup>+</sup> cells. Preliminary analysis indicates that there is no difference in survival among patients given CD34<sup>+</sup>-enriched cells and unmanipulated PBPCs (data not shown). Of the 58 patients who underwent a follow-up bone marrow examination after therapy, 63% of the relapsing patients vs. 5% of the patients in CR had CK<sup>+</sup> cells.

### Monitoring and Enumeration of CK<sup>+</sup> Cells

Table 2 lists some patients who were monitored for the presence of tumor cells in bone marrow at diagnosis and after therapy. All patients were given 3 cycles of chemotherapy and high-dose therapy with stem cell rescue. Patients 1 and 2 had no remaining residual disease detected in the stem cell product and in bone marrow 6 months after therapy. At 12 months, however, both had a significant increase in the number of tumor cells in the bone marrow followed by an aggressive relapse leading to death soon after. Patient 3 was found to have a high number of positive cells in the bone marrow at diagnosis and in the reinfused CD34<sup>+</sup> cell product 6 and

**Table 1.** Remission Status of 67 Breast Cancer Patients and Micrometastasis in Bone Marrow at Diagnosis and in Peripheral Blood Progenitor Cells and Bone Marrow After High-Dose Therapy\*

	<i>At Relapse</i>	<i>In Remission</i>
Bone marrow at diagnosis	11/21 (52)	12/46 (26)
Peripheral blood progenitor cells at treatment	8/21 (38)	7/46 (15)
Bone marrow after therapy	10/16 (63)	2/42 (5)

\*Data are the number of patients with cytokeratin-positive cells/number of patients studied (%).



**Table 2.** Minimal Residual Disease\*

Patient	Number of Tumor Cells per $1-2 \times 10^7$ Cells				Clinical status
	Bone Marrow at Diagnosis	PBPC at Treatment	Bone Marrow After Chemotherapy		
			6 mo	12 mo	
1	20	0	0	658	Dead
2	5	0	0	238	Dead
3	659	10†	33	28	Alive
4	41	0	39	225	Alive in relapse

\*The 4 patients were given 3 cycles of chemotherapy (FEC) plus high-dose chemotherapy (CTCb) with stem cell rescue. †Cytokeratin-positive cells remaining in the enriched CD34<sup>+</sup> fraction.

12 months after therapy, without any sign of clinical relapse. Patient 4 had persistent cells in bone marrow and PBPCs after high-dose therapy. After 12 months, the number of positive cells increased and the patient relapsed. Although these data are only observational, it would appear that the relapses observed in the patients might indicate failure of the high-dose treatment to eradicate minimal residual disease.

## DISCUSSION

Whether high-dose adjuvant therapy with stem cell support is more effective than standard-dose chemotherapy is still not answered. After extensive testing to optimize the enrichment procedure and immunocytochemistry, we used our method to determine whether the presence of CK<sup>+</sup> cells in bone marrow at diagnosis and in the PBPCs and bone marrow after therapy is related to patient outcome. It is well documented that the presence of micrometastases in bone marrow at diagnosis is a prognostic factor in breast cancer patients given standard-dose chemotherapy.<sup>4-6</sup> Our data appear to indicate that circulating CK<sup>+</sup> cells before high-dose therapy also predict a higher relapse after therapy. We find, as others have,<sup>13,14</sup> that a high proportion of patients had CK<sup>+</sup> cells in their PBPCs. Because many of our patients were transplanted with enriched CD34<sup>+</sup> cells, which in most cases removed the CK<sup>+</sup> cells, the present study cannot determine if reinfusion of contaminated PBPCs influences the clinical outcome of these patients.

Recently, it was published that the presence of CK<sup>+</sup> cells after adjuvant chemotherapy predicts relapse.<sup>12</sup> In our patients given high-dose therapy with stem cell support, a similar finding was observed, suggesting that the high-dose regimens given in our study were not able to eliminate breast cancer cells in the patients. Therefore, attention must be given to finding more efficient treatment

regimens in autotransplantation or to giving additional therapy following high-dose therapy to eradicate remaining minimal residual disease.

As can be seen in Table 2, immunomagnetic depletion of CD45<sup>+</sup> cells followed by immunocytochemistry opens up the possibility to monitor and enumerate tumor cells from patient samples. Furthermore, characterization of individual tumor cells from each patient sample is also possible. By performing double-staining of individual tumor cells in the bone marrow, it has been shown that metastatic cells have heterogeneous expression of antigens such as major histocompatibility complex (MHC) class I antigens and antigens against different proliferation-associated molecules.<sup>15</sup> In this study, downregulation of MHC class I antigens on tumor cells was observed, which in turn might lead to the escape of tumor cells from cytotoxic T lymphocytes. The lack of expression of proliferation antigens on tumor cells might also indicate that many of the micrometastatic tumor cells present in the bone marrow are dormant and resistant to chemotherapy. Until now, a small number of patients and a limited number of tumor cells from these patients have been studied. Therefore, no firm conclusions can be drawn about the clinical utility of further characterization of individual tumor cells by double-staining techniques.

Recently, promising results have been reported using monoclonal antibodies as therapy against solid tumors, either alone or in combination with chemotherapy.<sup>16</sup> Because immunotherapy-based strategies can work only on patients with low tumor load and against tumor cells expressing the target antigens, phenotyping of tumor cells and monitoring of in vivo tumor cell purging efficacy may become an important method in the near future.<sup>17</sup>

Altogether, the different procedures available to detect minimal residual disease are promising. Standardization programs are developing,<sup>18</sup> and as outlined in this article, monitoring minimal residual disease may enable us to better understand the biology of tumor cells from individual patients and lead to an improved and specific cancer treatment.

## REFERENCES

1. Lin F, Van Rhee F, Goldman JM, Cross NCP. Kinetics of increasing BCR-ABL transcript numbers in chronic myeloid leukemia patients who relapse after bone marrow transplantation. *Blood* 87:4473–4478, 1996.
2. Zippelius A, Kufer Å, Honold G, et al. Limitations of reverse-transcriptase polymerase chain reaction analyses for detection of micrometastatic epithelial cancer cells in bone marrow. *J Clin Oncol* 15:2701–2708, 1997.
3. Slade MJ, Brendan MS, Dudley Sinnett H, Cross NCP, Coombes RC. Quantitative polymerase chain reaction for the detection of micrometastases in patients with breast cancer. *J Clin Oncol* 17:870–879, 1999.

4. Diel IJ, Kaufmann M, Costa SD, et al. Micrometastatic breast cancer cells in bone marrow at primary surgery: prognostic value in comparison with nodal status. *J Natl Cancer Inst* 88:1652–1658, 1997.
5. Mansi JL, Gogas H, Bliss JM, Gazet JC, Berger U, Coombes RC. Outcome of primary-breast-cancer patients with micrometastases: a long-term follow-up study. *Lancet* 354:197–202, 1999.
6. Braun S, Pantel K, Mueller P, et al. Cytokeratin-positive cells in the bone marrow and survival of patients with stage I, II or III breast cancer. *N Engl J Med* 342:525–533, 2000.
7. Pantel K, Cote RJ, Fodstad O. Detection and clinical importance of micrometastatic disease. *J Natl Cancer Inst* 99:1113–1123, 1999.
8. Kvalheim G, Naume B, Nesland JM. Minimal residual disease in breast cancer. *Cancer Metastasis Rev* 18:101–108, 1999.
9. Pantel K, Schlimok G, Angstwurm M, et al. Methodological analysis of immunocytochemical screening for disseminated epithelial tumor cells in bone marrow. *J Hematother* 3:165–173, 1994.
10. Borgen E, Beiske K, Trachsel S, et al. Immunocytochemical detection of isolated epithelial cells in bone marrow: unspecific staining and contribution by plasma cells directly reactive to alkaline phosphatase. *J Pathol* 185:427–434, 1998.
11. Naume B, Borgen E, Nesland JM, et al. Increased sensitivity for detection of micrometastases in bone marrow/peripheral-blood stem-cell products from breast-cancer patients by negative immunomagnetic separation. *Int J Cancer* 78:556–560, 1998.
12. Braun S, Kantenich C, Janni W, et al. Lack of effect of adjuvant chemotherapy on the elimination of single dormant tumor cells in bone marrow of high-risk breast cancer patients. *J Clin Oncol* 18:80–84, 2000.
13. Moss TJ, Ross AA. The risk of tumor cell contamination in peripheral blood stem cell collections. *J Hematother* 1:225–232, 1992.
14. Ross AA, Cooper BW, Lazarus HM, et al. Detection and viability of tumor cells in peripheral blood stem cell collections from breast cancer patients using immunocytochemical and clonogenic assay techniques. *Blood* 82:2605–2610, 1993.
15. Pantel K, Felber E, Schlimok G. Detection and characterization of residual disease in breast cancer. *J Hematother* 3:315–322, 1994.
16. Disis ML, Cheever MA. HER-2/neu protein: a target for antigen-specific immunotherapy of human cancer. *Adv Cancer Res* 71:343–371, 1997.
17. Schlimok K, Pantel K, Loibner H, Fackler-Schwalbe I, Riethmuller G. Reduction of metastatic carcinoma cells in bone marrow by intravenously administered monoclonal antibody: towards a novel surrogate test to monitor adjuvant therapies of solid tumors. *Eur J Cancer* 11:1799–1803, 1995.
18. Borgen E, Naume B, Nesland JM, et al. Standardization of immunocytochemical detection of cancer cells in BM and blood, I: establishment of objective criteria for the evaluation of immunostained cells. The European ISHAGE Working Group for Standardization of Tumor Cell Detection. *Cytotherapy* 1:377–388, 1999.

# **The Prediction of Breast Cancer Contamination in Stem Cell Products by Immunocytochemical Analysis of Premobilized Peripheral Blood**

***Tehila Umiel, Sebastian George, Robert Joyce, Thomas J. Moss***

*IMPATH/BIS Inc., Reseda, California; Cancer and Blood Institute of the Desert, Rancho Mirage, California; Baptist Medical Center, Jacksonville, Florida*

## **ABSTRACT**

One of the end points of the collection of peripheral blood stem cells (PBSCs) before marrow-ablative chemotherapy and autologous transplantation is tumor-free product. One way to obtain a tumor-free graft is to perform purging. However, because purging is an expensive procedure, purging of all grafts would not be cost-effective. To determine if one could predict the contamination of a stem cell graft, we evaluated premobilized peripheral blood (PB) for the presence of tumor cells. Using a routine immunocytochemical (ICC) assay (sensitivity 1/1,000,000), tumor cells were detected before mobilization in PB of 32 (5%) of 635 breast cancer patients. Paired premobilized PB specimens and samples from PBSC products were available from 460 patients. From these paired samples, 25 PB (5.4%) and 100 PBSC (21.7%) samples were positive for tumor cells. Breast cancer cells were detected in 24 of 25 PBSC samples (96%) when the premobilized PB sample contained tumor cells. Due to the low positive rate of PB samples, a number of PBSC products positive for tumor cells went unpredicted. Therefore, it was necessary to develop a tumor-enriched ICC (EICC) assay that could detect routinely 1/10,000,000 tumor cells. In seeding experiments, CAMA cells were seeded into aliquots of PBSCs from normal donors at concentrations of 1/1,000,000, 1/5,000,000, 1/10,000,000, 1/20,000,000, and 1/50,000,000. Overall tumor cell recovery in the positive fractions of the various seeded samples ranged between 56% and 97%. This EICC system was then used to enrich tumor cells from PB of breast cancer patients. For 107 PB samples of early stage (I–III) and 42 of stage IV patients, EICC-positive cells were found in 23 (21%) and 25 (59.5%) patients, respectively. The EICC assay now permits testing of PB for residual cancer cells in a larger percentage of breast cancer patients. The use of this assay in premobilized PB may permit the early identification of subset of patients with an extremely high probability of having breast cancer cells in their PBSC products, who may require purging of their products.

## INTRODUCTION

High-dose chemotherapy with autologous stem cell transplant may be an effective treatment for patients with advanced breast cancer.<sup>1</sup> The major reason for peripheral blood stem cell treatment failure is relapse of disease, which may in part be a result of reinfusion of tumor cells in the graft.<sup>2</sup> The presence of tumor cells in the reinfused grafts of some breast cancer patients is well established.<sup>3-5</sup> Circulating breast cancer cells have been found to increase as a result of the type of mobilization regimens used and with the number of PBSC collections.<sup>6,7</sup> In addition, these contaminating cells have been shown to be viable and are capable *in vitro* clonogenic growth.<sup>3,4</sup> Gene-marking studies of patients with chronic myeloid leukemia, lymphoma, and neuroblastoma have shown that tumor cells in the graft contribute to relapse in patients.<sup>8-10</sup> Finally, the presence of tumor cells in stem cell products has been correlated with a poor posttransplant clinical outcome.<sup>11-14</sup>

One way to get a tumor-free PBSC product is to purge the graft. A variety of approaches for tumor purging have been characterized. These include immunomagnetic cell depletion via positive or negative selection, pharmacological purging (such as 4-hydroperoxycyclophosphamide), immunotoxins, and density gradient separation.<sup>15-18</sup> Purging of all PBSC products may be prohibitively expensive, particularly when the contamination is only 10%–25%. Therefore, if we can predict which PBSCs are positive before harvesting, we could purge only a subset of PBSC products and provide better cost efficiency.

The aim of this study was to develop a premobilized assay that can predict the presence of tumor cells in PBSC products of transplant patients. We have been using an alkaline phosphatase (AP)-based ICC assay with a routine sensitivity of 1/1,000,000. Using this assay, premobilized PB cells of patients were evaluated for contaminating tumor cells and correlated with tumor cell contamination in their PBSC products. When the PB was positive, the assay had high predictive power to identify patients with breast cancer cells in PBSC infusions. However, a major problem was that a number of ICC-negative premobilized PB samples did not predict for a negative PBSC harvest. This may be due to inadequate sensitivity of the ICC assay for the evaluation of blood.

To identify breast cancer cells that are present in low numbers in premobilized PB, we developed an ultrasensitive tumor-enriched immunocytochemical micrometastatic assay that has a sensitivity of 1/10,000,000. This system uses the Miltenyi magnetic cell sorting (MACS) immunomagnetic selection device using colloidal superparamagnetic microbeads conjugated with anti-epithelial (HEA-125) monoclonal antibody (mAb) to enrich tumor cells before ICC analysis.

## MATERIALS AND METHODS

### Cell Lines

The breast cancer cell line CAMA was maintained in 15% fetal bovine serum (FBS) (Gibco/BRL, Life Technologies, Rockville, MD) and Dulbecco's modified Eagle's medium (DMEM) (Sigma, St. Louis, MO) with 2  $\mu$ M L-glutamine and 100 U/mL penicillin-streptomycin.

### Monoclonal Antibodies

For ICC analysis, antibodies previously described were used.<sup>4</sup> For EICC, SB-3/TFS-2 anti-cytokeratin mAb cocktail was used. TFS2 mAb (IgG2b; Biodesign International, Kennebunkport, ME) recognizes a 39-kDa carcinoma-specific surface antigen, and the SB-3 mAb (MeDica, Carlsbad, CA) recognizes an epitope on cytokeratin 8 (CK8) and CK18.

### Processing and Immunostaining

Aliquots of PBSCs (at least  $2 \times 10^7$  cells) were shipped at room temperature to IMPATH/BIS for ICC analysis. Mononuclear cell fractions were isolated by density gradient centrifugation using Ficoll-Hypaque (Pharmacia & Upjohn, Bridgewater, NJ) and washed twice in Leibovitz L-15 medium (Gibco/BRL) supplemented with 10% FBS. The mononuclear fraction was collected, and cells were spun onto slides for immunostaining. Slides were fixed in paraformaldehyde/methanol (2:1) or 4% paraformaldehyde fixative, washed thoroughly in Dulbecco's modified phosphate-buffered saline (PBS) (Gibco/BRL), and placed on an automated immunostainer (TechMate; Ventana, Tucson, AZ). AP immunostaining was then performed per manufacturer's instructions as previously described.<sup>12</sup> Briefly, slides were incubated in the following order: blocking solution, primary antibody cocktail, secondary antibody, AP complex, chromogen, and hematoxylin. Buffer washes were performed between each step. Positive control slides consisted of CAMA cells seeded into normal PB or bone marrow and immunostained as above. Negative control slides were the patient's specimen immunostained with normal mouse serum at the same concentration as used for the anti-breast cancer antibodies.

### Quantitation of Tumor Cell Concentration

Slides were evaluated on a blinded basis, and the total number of tumor cells, identified by microscopic evaluation, was recorded. In addition to displaying immunostaining, cells had to exhibit morphology consistent with malignant

phenotype to score as breast cancer cells. For standard ICC, tumor cell frequency was calculated as the quotient of total number of tumor cells detected divided by total number of cells on the slides. For EICC, tumor frequency was derived by taking the total number of cells detected and dividing by the number of cells used for enrichment.

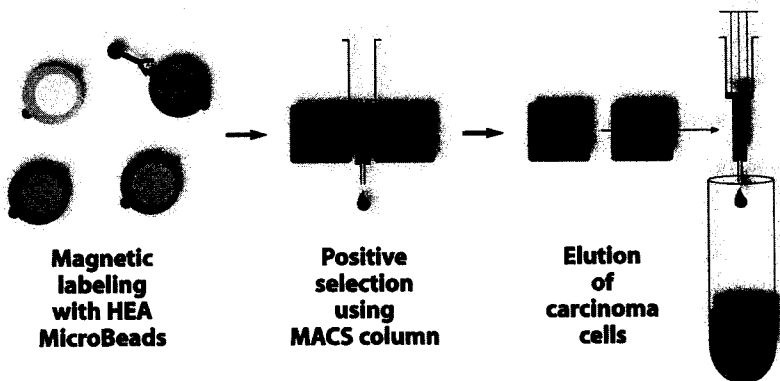
### Generation of Seeded Tumor Cells

CAMA cultured breast cancer cells were removed from tissue culture flasks, washed twice, and placed in L-15/FBS medium at a concentration of  $1 \times 10^6$  cells/mL.

The hematopoietic cell fractions from normal donors were divided into six  $2 \times 10^8$  cell fractions. Tumor cells were spiked into these fractions at concentrations of 0, 1/1,000,000, 1/5,000,000, 1/10,000,000, 1/20,000,000, and 1/50,000,000. Enrichment for tumor cells using HEA-125 mAb-conjugated beads was performed on all cell aliquots. Cytopreparations from the nonenriched and enriched material were made for all aliquots.

### EICC Assay

Figure 1 shows a diagram of enrichment of disseminated carcinoma cells using the HEA microbeads and MACS technology. The mononuclear cell fraction was isolated by Ficoll-Hypaque separation, washed twice in Leibovitz L-15 medium supplemented with 10% FBS, and placed in L-15/FBS at a concentration of  $1 \times 10^8$  cells/mL. Cells were then subjected to immunomagnetic cell selection using an anti-HEA-125 mAb magnetic microbead conjugate



**Figure 1.** Schematic representation for enrichment of disseminated carcinoma cells using HEA-125 microbeads and magnetic cell sorting (MACS) technology.

(Miltenyi Biotec, Auburn, CA). The HEA-125 antigen is an epithelial-specific surface glycoprotein, widely expressed by human carcinoma.<sup>19</sup> The system and magnetic cell separation columns were used according to manufacturer's instructions. Briefly, mononuclear cells from PB or PBSC were placed in PBS containing 0.2% sodium citrate and washed twice at 1000 rpm for 10 minutes each. After washing, cells were incubated with a blocking reagent and HEA-125 antibody-conjugated microbeads at 4°C for 30 minutes. The cells were washed twice with PBS and sodium citrate (0.2%) to remove unbound beads and placed in a separation column along with a MiniMACS magnet for 2 minutes at room temperature to bind cells. Bound cells were removed by gentle flushing of the column with 1 mL buffer using a plunger into fresh tube. All bead:cell conjugates recovered from the magnet were used in cytopreparations and immunostained. Two to 4 cytopreparations were made with the Shandon cytospin and stored for immunostaining at 4°C. Cytopreparations were fixed in 4% paraformaldehyde fixative, washed thoroughly in Dulbecco's modified PBS with 1% Triton X, and placed on an automated immunostainer. AP immunostaining was performed per protocol.

## RESULTS

### Detection of Tumor Cells in Premobilized Blood Specimens

An ICC-based assay with a routine sensitivity of 1/1,000,000 was used to evaluate premobilized PB cells of stage II (high risk), stage III, and stage IV breast cancer patients for contaminating tumor cells and to correlate with tumor cell contamination in their PBSC products.

PB before mobilization was available from 635 breast cancer patients. ICC was positive in 32 (5.0%). Paired premobilized PB specimens and PBSC products were available from 460 patients. From these paired samples, 25 PB (5.4%) and 100 PBSC (21.7%) specimens were positive for tumor cells. The range of tumor cells detected was 1/100,000 to 1/6,000,000, median 1/2,000,000. The results of the paired samples are summarized in Table 1. Breast cancer cells were detected in 24 of 25 PBSC products (96%) when the premobilized PB contained tumor cells. However, in 77 of 435 patients, the premobilized PB was ICC negative, yet the PBSC had tumor cells present (false-negative rate of 17.7%). Although a positive ICC of premobilized PB was highly predictive of a positive PBSC, there were a number of false-negative cases. This false-negative rate was probably due to the presence of tumor cells in PB at concentrations less than 1/1,000,000. Thus, we developed a tumor-enriched assay.



**Table 1.** Tumor Cell Contamination Using Immunocytochemical (ICC) Assay in Paired Peripheral Premobilized Blood and Peripheral Blood Progenitor Cells (PBSCs) of Breast Cancer Patients\*

Number of patients	358	77	24	1
Peripheral blood	–	–	+	+
PBSCs	–	+	+	–

\*–, no tumor cells were found in ICC analysis; +, tumor cells were detected.

### EICC Tumor Cell Seeding Experiments

The efficacy of the tumor enrichment assay was evaluated in a model system in which cultured CAMA breast cancer cells were seeded into PBSC products of normal donors. In initial studies, EICC analysis of PBSCs seeded with CAMA cells at a concentration of 1/1,000,000 was evaluated after enrichment with HEA-125 magnetic beads. Initial recovery studies of CAMA cells from PBSCs demonstrated an average recovery of 74% ( $n = 16$ , 52%–96%). No tumor cells were detected in any of the negative fractions following enrichment. In the next set of experiments, CAMA cells were seeded into aliquots of PBSCs from normal donors at concentrations of 1/1,000,000 (200 cells), 1/5,000,000 (40 cells), 1/10,000,000 (20 cells), 1/20,000,000 (10 cells), and 1/50,000,000 (4 cells). Samples of  $2 \times 10^8$  cells were seeded and tested for tumor using the above enrichment system.

The results from the tumor seeding experiments showed that using the Miltenyi enrichment system, tumor cells were detected in all seeded products, even when seeded with as low as 1/50,000,000 (4 cells). Overall recovery in the various seeded samples in 4 independent experiments ranged between 56.2% and 97.5%. Mean tumor cell recovery was 97.2% (range, 37%–119%), 74.2% (14%–167%), 62% (30%–120%), 95% (10%–200), and 56.2% (0%–125%) of PBSC samples seeded at 1/1,000,000, 1/5,000,000, 1/10,000,000, 1/20,000,000, and 1/50,000,000, respectively.

The specificity of the enrichment assay was assessed using nonseeded PBSCs or PB from 50 normal donors or from patients with hematologic malignancies. None of these normal donor specimens tested positive.

### Patient Specimens

The standard ICC and EICC tumor cell detection system was then tested and compared on PBSCs taken from breast cancer patients with various disease stages, all candidates for PBSC transplantation. The results are summarized in Table 2. Using standard ICC, contaminating tumor cells were found in 33%, 28.6%, and

16.6% compared with EICC, where tumor cell contamination was evident in 58%, 42.8%, and in 58% of patients' specimens for stage II, III, and IV, respectively. Tumor cell concentration ranged from 1/1,500,000 to 1/25,000,000. When the results of all 31 patients were combined, only 26% of patient specimens were found to be positive using the standard ICC assay vs. 55% using the EICC assay ( $P=.002$ ).

The ICC and EICC results were compared on premobilized PB samples of breast cancer patients. Of 635 premobilized PB samples of breast cancer patients using standard ICC, the positive rate was 32 (5.0%), and in a different but comparable group of patients, the EICC positive rate was 25 of 42 (59.5%). Tumor concentration for these samples ranged from 6/10,000,000 to 2/100,000,000.

The power of the EICC assay was also tested on PB of early-stage patients with epithelial malignancies. There were 40 patients with breast cancer, 43 with prostate cancer, 15 with gastrointestinal cancer, and 9 with lung cancer. Of the 107 early-stage patients, 23 (21.0%) were positive for tumor cells in the PB. When circulating tumor cells were evaluated in PB of stage IV patients, a ~45% positive rate was found.

## DISCUSSION

One of the end points of PB SCT is obtaining a tumor-free product. One way to get a tumor-free PBSC product is to use methods that would reduce the number of tumor cells in the graft, including alternative mobilization regimens and purging of the PBSC product.<sup>16-18</sup>

One promising method for purging is the indirect tumor reduction that occurs with positive selection of CD34<sup>+</sup> cells from PBSC products.<sup>20</sup> Studies have demonstrated that ~1-2 logs of breast cancer tumor cells can be removed using this process.<sup>21-23</sup> Because this is an expensive procedure, however, the use of CD34 selection must be questioned when the PBSC is negative for tumor cells. Therefore, being able to predict which patient will have positive PBSCs could make CD34 collection more cost-effective.

**Table 2.** Comparison Between Standard Immunocytochemical (ICC) and Tumor-Enriched ICC (EICC) Results Using Peripheral Blood Stem Cell Specimens Taken From Breast Cancer Patients at Various Stages of Disease\*

Stage	Specimens	ICC	EICC
II	12	4 (33.3)	7 (58.3)
III	7	2 (28.6)	3 (42.8)
IV	12	2 (16.6)	7 (58.3)
Acute lymphoid leukemia	31	8 (25.8)	17 (54.8)

\* Data are n or n (%).  $P=.002$ .

In this study, we evaluated the power of premobilized ICC PB specimens for predicting PBSC tumor cell contamination. We hypothesized that if this assay proves to have predictive value, it would be possible to determine which PBSC products are positive before harvesting. The assay could permit transplant physicians to purge only a subset of PBSC products, rather than all products.

The standard ICC assay in this study, with a sensitivity of 1/1,000,000, was thus used to evaluate tumor cell contamination in premobilized PB and PBSC products. In paired samples, breast cancer cells were detected in 24 of 25 PBSC products (96%) when the premobilized PB sample contained tumor cells. However, in 77 of 435 patients, the premobilized PB ICC was negative, yet PBSCs had tumor cells present (a false-negative rate of 17.7%).

To improve the predictive power of this analysis, we developed an ultrasensitive tumor-enriched assay with a sensitivity of 1/10,000,000. For EICC seeding experiments, a high tumor cell recovery with an overall mean tumor cell recovery between 56.2% and 97.5% was found. Moreover, tumor cell recovery was adequate even when tumor cell seeding concentrations were as low as 1/20,000,000 and 1/50,000,000.

The superior detection power of EICC was proven on PBSC and PB samples taken from cancer patients. For patients with breast cancer, the standard ICC assay was positive in 32 of 635 (5.0%), whereas the EICC assay was positive in 25 of 42 (59.5%). For patients with a variety of early-stage cancers, the EICC assay was positive in 23 of 107 (21%).

The breast cancer ultrasensitive EICC method described in this study showed a significant increase in sensitivity of tumor detection in premobilized PB as well as in PBSC products compared with standard ICC. Based on the predictive power of ICC-analyzed premobilized PB, we anticipate that the EICC analysis will greatly reduce the false-negative rate. This EICC approach could be used to predict the presence of tumor cells in PBSC products before mobilization. The information obtained can then be applied to determine the need for purging subsets of grafts rather than all the grafts. In addition, the EICC assay has potential to be used in future investigations to study the relationship between premobilized PB contamination and patient outcomes. Studies toward this end are currently being conducted in our laboratory.

## REFERENCES

1. Antman KH, Hetijan DF, Hortobagyi GN. High-dose chemotherapy for breast cancer. *JAMA* 282:1701–1703, 1999.
2. Berman SI, Shpall EJ, Jones RB, Cagnoni PG, Ross M. High-dose chemotherapy with autologous hematopoietic progenitor cell support for metastatic and high-risk primary breast cancer. *Semin Oncol* 23 (1 Suppl 2):60–67, 1996.

3. Sharp JJ, Kessinger A, Vaughn WP, et al. Detection and clinical significance of minimal tumor cell contamination of peripheral stem cell harvests. *Int J Cell Clon* 10 (Suppl 1): 92, 1992.
4. Ross AA, Cooper BW, Lazarus HM, et al. Detection and viability of tumor cells in peripheral blood stem cell collections from breast cancer patients using immunocytochemical and clonogenic assay techniques. *Blood* 82:2605–2610, 1993.
5. Simpson SJ, Vachula M, Kennedy MJ, et al. Detection of tumor cells in the bone marrow, peripheral blood, and apheresis products of breast cancer patients using flow cytometry. *Exp Hematol* 23:1062–1068, 1995.
6. Brugger W, Bross KJ, Glatt M, Weber F, Mertelsman R, Kanz L. Mobilization of tumor cells and hematopoietic progenitor cells into peripheral blood of patients with solid tumors. *Blood* 83:636–640, 1994.
7. Pecora AL, Lazarus HM, Cooper B, et al. Breast cancer contamination with bone marrow disease and the type of mobilization. *Blood* 99 (Suppl 1):405b, 1997.
8. Brenner MK, Rill DR, Moen RC, et al. Gene-marking to trace the origin of relapse after autologous bone marrow transplantation. *Lancet* 341:85–86, 1993.
9. Deisseroth AB, Zu Z, Claxton D, et al. Genetic marking shows that Ph<sup>+</sup> cells present in autologous transplants of chronic myelogenous leukemia (CML) contribute to relapse after autologous bone marrow in CML. *Blood* 83:3068–3076, 1994.
10. Rill DR, Santana VM, Roberts WM, et al. Direct demonstration that autologous bone marrow transplantation for solid tumors can return a multiplicity of tumorigenic cells. *Blood* 84:380–383, 1994.
11. Gribben JG, Freedman AS, Neuberg D, et al. Immunologic purging of marrow assessed by PCR before autologous bone marrow transplantation for B-cell lymphoma. *N Engl J Med* 325:1525–1533, 1991.
12. Moss TJ. Minimal cancer detection in hemopoietic stem cell products and its prognostic significance in patients with breast cancer, lymphoma, or multiple myeloma. *Cancer Control* 5:326–334, 1998.
13. Vannucchi AM, Bosi A, Glinz S, et al. Evaluation of breast tumor cell contamination in the bone marrow and leukapheresis collection by RT-PCR for cytokeratin-19 mRNA. *Br J Haematol* 103:610–617, 1998.
14. Schulz R, Schultz M, Wischink A, et al. Tumor cell contamination of peripheral blood stem cells transplant and bone marrow in high-risk breast cancer patients. *Bone Marrow Transplant* 19:1223–1228, 1997.
15. Noga SJ, Kennedy MJ, Valone F, et al. Density-adjusted cell sorting (DACS) combined with negative CD45 enrichment of hematopoietic stem cells (HSC) harvests increases the sensitivity of immunocytochemical (ICC) detection for breast cancer [abstract]. *Proc ASCO* 16:102a, 1995.
16. Shpall EJ, Bast JR, Joines WT, et al. Immunomagnetic purging of breast cancer from bone marrow for autologous transplantation. *Bone Marrow Transplant* 7:145–151, 1991.
17. Passos-Coelho J, Ross AA, Davis JM, et al. Bone marrow micrometastases in chemotherapy-responsive advanced breast cancer: effect of ex vivo purging with 4-hydroperoxycyclophosphamide. *Cancer Res* 54:2366–2371, 1994.
18. Naume B, Borgen E, Nesland JM, et al. Increased sensitivity for detection of micrometas-

- tases in bone marrow/peripheral blood stem-cell product by negative immunomagnetic separation. *Int J Cancer* 78:556–560, 1998.
19. Kruger W, Togel F, Rossing S, Zander AR. Improvement of breast cancer cell detection by immunomagnetic enrichment. *Cytotherapy* 1:135–139, 1999.
  20. Roots-Weiss A, Papadimitriou C, Serve H, et al. The efficacy of tumor cell purging using immunomagnetic CD34<sup>+</sup> separation systems. *Bone Marrow Transplant* 19:1239–1246, 1997.
  21. Shpall EJ, Jones RB, Bearman SI, et al. Transplantation of enriched CD34-positive autologous marrow into breast cancer patients following high-dose chemotherapy: influence of CD34-positive peripheral-blood progenitors and growth factors on engraftment. *J Clin Oncol* 12:28–36, 1994.
  22. Mapara MY, Korner LJ, Hildebrandt M, et al. Monitoring of tumor cell purging after highly efficient immunomagnetic selection of CD34<sup>+</sup> cells from leukapheresis products in breast cancer patients: comparison of immunocytochemical tumor cell staining and reverse transcriptase-polymerase chain reaction. *Blood* 89:337–344, 1997.
  23. Umieł T, Prilutskaya M, Nguyen NH, et al. Breast tumor contamination of peripheral blood stem cell harvest: increased sensitivity of detection using immunomagnetic enrichment. *J Hematother*. In press.

# Reliable and Sensitive Analysis of Occult Bone Marrow Metastases Using Automated Cellular Imaging

**Kenneth D. Bauer, Jose de la Torre-Bueno, Ingo J. Diel, Debra Hawes, William J. Decker, Carl Priddy, Blaise Bossy, Susan Ludmann, Karen Yamamoto, Aneal S. Masih, Froilan P. Espinoza, Douglas S. Harrington**

*ChromaVision Medical Systems and Quest Diagnostics, San Juan Capistrano, California; Department of Obstetrics and Gynecology, University of Heidelberg, Germany; Department of Pathology and Laboratory Medicine, University of Southern California, Los Angeles, California; Space Coast Pathologists, P.A., Melbourne, Florida*

## ABSTRACT

The presence of occult bone marrow metastases (OM) has been reported to represent an important prognostic indicator for patients with operable breast cancer and other malignancies. Assaying for OM most commonly involves labor-intensive manual microscopic analysis. The present report examines the performance of a recently developed automated cellular image analysis system, Automated Cellular Imaging System (ACIS) (ChromaVision Medical Systems), for identifying and enumerating OM in human breast cancer specimens.

OM analysis was performed after immunocytochemical staining. Specimens used in this study consisted of normal bone marrow ( $n = 10$ ), bone marrow spiked with carcinoma cells ( $n = 20$ ), and bone marrow obtained from breast cancer patients ( $n = 39$ ).

The reproducibility of ACIS-assisted analysis for tumor cell detection was examined by having a pathologist evaluate montage images generated from multiple ACIS runs of 5 specimens. Independent ACIS-assisted analysis resulted in the detection of an identical number of tumor cells for each specimen in all instrument runs. Further studies were performed to analyze OM from 39 breast cancer patients, with 2 pathologists performing parallel analysis using either manual microscopy or ACIS-assisted analysis. In 7 of the 39 cases (44%), specimens were classified by the pathologist as positive for tumor cells after ACIS-assisted analysis, whereas the same pathologist failed to identify tumor cells on the same slides following analysis by manual microscopy.

These studies indicate that the ACIS-assisted analysis provides excellent sensitivity and reproducibility for OM detection, relative to manual microscopy. Such performance may enable an improved approach for disease staging and stratifying patients for therapeutic intervention.

## INTRODUCTION

A substantial body of literature exists evaluating the biologic significance of OM<sup>1</sup> from patients with operable breast cancer and a spectrum of other solid tumor types. Many studies have concluded that the presence of OM provides important prognostic information predictive of disease-free and overall survival in both locally recurring and advanced breast cancer.<sup>1-5</sup> Similar conclusions have been made following the analysis of other human solid tumors including non-small cell lung carcinoma, colorectal carcinoma, and esophageal carcinoma.<sup>6-8</sup>

In contrast, other reports have found no statistically significant relationship between OM and prognosis.<sup>9,10</sup> The issue of varying conclusions regarding the prognostic significance of OM was recently investigated by Funke and Schraut.<sup>11</sup> These authors performed a meta-analysis of 20 published reports, including the analysis of approximately 2500 patients. Although significant, the impact of this study was diminished by the fact that the authors compared a range of carcinoma types and included studies with highly variable staining and analysis methods, along with substantial variation in the duration of clinical follow-up. Despite these caveats, there is no doubt that a key conclusion of the authors is correct: There remains the need for improved standardization of OM assay methods before the prognostic significance of OM can be substantiated.

Surprisingly, large (greater than 10-fold) differences in the number of bone marrow cells analyzed for OM classification are evident in previously published reports. Most studies evaluated between  $10^5$  and  $10^6$  normal bone marrow cells, but in some cases the number of cells analyzed was not specified. Such variation clearly affects the sensitivity of the OM assay, and could affect the prognostic significance of the results obtained.<sup>12</sup> The importance of standardizing the number of cells assayed is further underscored from studies of Cote et al.<sup>1</sup> These studies suggest that the prognostic predictability of the OM assay is affected by the number of tumor cells in the specimen, as opposed to simply whether a specimen is positive or negative for the presence of tumor cells.

The analytical requirement for identifying and enumerating very rare tumor cells in the OM assay is highly laborious, with the accuracy and sensitivity of the result potentially affected by the fatigue of the reviewer. Variation in results between laboratories is further complicated by the use of varying criteria for the classification of cells as tumor or nontumor.<sup>13,14</sup> By providing objective computer-based analysis that can reduce the subjectivity inherent in manual microscopic

interpretation, along with images of cells that are classified, automated cellular imaging holds considerable potential for improving both the sensitivity and the interlaboratory consistency of the OM assay.

Previous reports<sup>15-17</sup> have provided initial proof-of-concept regarding the use of image analysis for rare tumor cell detection. Mansi et al.<sup>15</sup> analyzed bone marrow specimens that were spiked with human carcinoma cells. In that study, image analysis results agreed with those of manual microscopy in only 11 of 20 cases, and image analysis was reported to be considerably slower than analysis by manual microscopy. Mesker et al.<sup>16</sup> used a cell model system in which carcinoma cells were spiked into peripheral blood. The results of that study suggested that the image analysis-based detection of rare SKBR3 tumor cells could provide good correlation with results from manual microscopy when both specimen preparation and immunocytochemical staining were optimized. Kraeft et al.<sup>17</sup> recently described a fluorescence-based imaging system capable of identifying rare carcinoma cells in blood, bone marrow, and stem cell-enriched products. This system was reported to perform sensitive analysis of rare tumor cells from these specimens, although the consistency of tumor cell detection using the instrument was not addressed.

In the present study, the performance of a recently developed automated cellular imaging system (ACIS; ChromaVision Medical Systems) as a tool for the evaluation of OM is explored. Results are described following the analysis of normal human bone marrow, bone marrow specimens spiked with breast carcinoma cells, and bone marrow specimens from 39 breast cancer patients. OM assay sensitivity by ACIS-assisted analysis is compared with parallel analysis of the same specimens using manual microscopy. The performance of the imaging system in terms of OM assay reproducibility is also examined.

## METHODS

### Bone Marrow Specimens

Bone marrow specimens from breast cancer patients in this study were provided by Dr. Ingo Diel. They were obtained from patients with primary operable breast cancer, stage T1-4, N0-2, and M0 (International Union Against Cancer criteria).<sup>18</sup> Bone marrow puncture and aspiration were performed as detailed in Diel et al.<sup>3</sup> Bone marrow aspirate (10-12 mL) was collected from 2 puncture sites on each anterior iliac crest (total, 40-50 mL) and stored in heparinized tubes with Dulbecco's modified Eagle's medium (DMEM) (Gibco, Paisley, UK). Components of the aspirate were separated by density centrifugation through Ficoll-Hypaque (density = 1.077 g/mL; Biochrom, Berlin, Germany). After separation, cells were washed twice and resuspended with DMEM. Subsequently,



the cell suspension was transferred onto microscope slides using a cytocentrifuge (Universal 16A; Hettich, Tuttlingen, Germany). The slides were suspended in a conventional freezing medium and stored in a freezer at  $-80^{\circ}\text{C}$  before immunocytochemical staining and analysis.

For normal human bone marrow or bone marrow spiked with carcinoma cells, the following procedure was employed. Mononuclear cells were isolated from human bone marrow aspirates using standard protocols (Poietics, BioWhittaker, Gaithersburg, MD). Briefly, a nucleated cell count was performed on bone marrow aspirates using a Coulter counter with Zap-globin-II for red cell lysis, according to manufacturer's directions. The bone marrow was diluted to 5 million nucleated cells/mL with 5 mM EDTA (Sigma), pH 7.4. Fifteen milliliters of Ficoll-Paque Plus (Amersham Pharmacia, Piscataway, NJ) was overlaid with 35 mL of the diluted bone marrow in a 50-mL conical tube and centrifuged at 400g for 30 minutes at room temperature. The mononuclear cell layer was harvested from each tube, combined, diluted 1:4 with Hanks' balanced salt solution and EDTA, and centrifuged at 300g for 15 minutes at room temperature. The cells were resuspended in phosphate-buffered saline (PBS) (Dako, Carpinteria, CA), and an aliquot was counted. The cells were centrifuged at 250g for 10 minutes at room temperature. The mononuclear cells were resuspended in PBS at 5 million cells/mL and maintained on ice. Two hundred microliters of the cell suspension (~1 million cells) was cytocentrifuged (Hettich Universal 16A) onto silanized slides (Dako) at 500 rpm for 5 minutes at room temperature. The supernatant was carefully removed from each slide after cytocentrifugation, and the slides were allowed to air-dry overnight. For spiked slides, MDA-MB-468 breast carcinoma cells (ATCC, Manassas, VA) were harvested, resuspended in PBS, and counted. The appropriate number of cells was added to the PBS-resuspended bone marrow mononuclear cells to give a final count of 1.5 or 40 cells in 200  $\mu\text{L}$ . Slides were prepared by cytocentrifugation as described above.

### **Immunocytochemical Staining**

Details of the procedure used for the staining of bone marrow specimens from breast carcinoma patients are presented in Diel et al.<sup>3</sup> Briefly, the monoclonal antibody 2E11 (BM2), which recognizes a carcinoma-associated epithelial mucin MUC-1,<sup>19-21</sup> was used.

Before staining, the cells were fixed with 3.7% formalin in PBS for 15 minutes, rinsed 3 times with PBS, and postfixed with absolute methanol ( $-20^{\circ}\text{C}$ ) for 5 minutes. Endogenous alkaline phosphatase was next blocked with 20% acetic acid, 2.28% periodic acid, and 2% levamisole. After blocking, the slides were incubated with biotinylated BM2 antibody (2  $\mu\text{g}/\text{mL}$ ) in PBS that contained 1% bovine serum albumin (Boehringer Mannheim, Mannheim, Germany) for 1 hour at

room temperature. Immune complexes were made visible by use of the avidin-biotin-alkaline phosphatase complexes (ABC test; Vectastain, Camon, Wiesbaden, Germany) and fast red as substrate. The cells were counterstained with 10% Gill 2 hematoxylin (Dako) in distilled water for 30 seconds. The specimen was next rinsed under running water for 2 minutes then coverslipped using Aquatex mounting medium (Merck, Darmstadt, Germany).

Normal marrow or bone marrow specimens spiked with human breast carcinoma cells were immunocytochemically stained using the EPiMET Epithelial Cell Detection Kit (Baxter Europe, Micromet, Martinsried, Germany) with minor modifications to the manufacturer's recommendations. Briefly, slides were fixed in 0.5% neutral buffered formalin (Sigma, St. Louis, MO) diluted in PBS (Dako) for 10 minutes at room temperature. Samples were gently washed with PBS and permeabilized according to the manufacturer's recommendations. Cytokeratins 8, 18, and 19 were stained with A45-B/B3 (conjugate of Fab-fragment of antibody A45-B/B3 with alkaline phosphatase), washed, and detected with chromogen (New Fuchsin) according to the manufacturer's recommendations. The slides were counterstained by incubating in undiluted hematoxylin stain (Dako) for 4 seconds and rinsed with deionized water. The slides were dried at 70°C in a drying oven for 20 minutes. The dried slides were coverslipped with a cellulose film using a Tissue-Tek SCA automated coverslipper (Sakura Finetek) and xylene.

### **ACIS SYSTEM OVERVIEW**

The ACIS consists of 2 major subassemblies. The first is the microscope with its associated electromechanical hardware, and the second is a computer with a frame grabber and image processing system.

The microscope subsystem includes the components of a standard microscope (lamp, condenser, turret, etc) mounted in a special shock-resistant frame with a video camera. The camera has a 60-frame-per-second, 640-by-480-pixel, 3-chip camera (Sony DX9000). Also included in the microscope assembly is an infeed hopper, a stage, motors that provide X, Y, and Z (focus) translation, and an outfeed drawer. The system uses a carrier system, with 4 slides per carrier, and the input hopper is capable of holding 25 carriers. The computer subsystem consists of a dual 450 MHz Pentium II computer running Microsoft Windows NT. It has 512 megabytes of memory, 27 gigabytes of hard disk storage, and 25 gigabytes of tape backup, compressible to 50 gigabytes.

For rare event detection, the ACIS makes use of proprietary software allowing for fast and highly sensitive color detection, along with the capability for the analysis of a variety of morphometric features. The application software available on the ACIS for OM detection involves first scanning a microscope slide at low magnification ( $\times 10$ ). The system next returns to objects that were originally

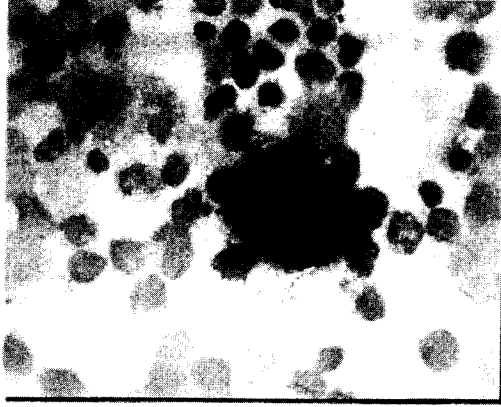
identified for a second analysis at higher magnification ( $\times 40$  or  $\times 60$ ). In this case, more comprehensive image analysis of color and morphometric characteristics (nuclear size, nuclear shape) is undertaken in an effort to exclude cellular debris, large clumps, and cells with morphological features typical of normal hematologic mononuclear cells, as opposed to carcinoma cells. At the same time, objects that meet color- and morphometry-based criteria as likely tumor cells are collected and presented as montage images for review and classification by a pathologist or other laboratory professional. In the data file generated after specimen analysis, the  $x$  and  $y$  coordinates of the object within a framelet are stored using location data results in powerful sample navigation features. A revisit capability allows the user to double-click on framelets of interest to return to the proper location on the specimen slide for further review under manual control of the microscope. In this mode, it is possible to navigate across the slide, adjust focus, and change microscope objectives. Comparison of the montage images that result from each repeated run is another feature that uses location data. Tumor cells or cell clusters found multiple times by the system can be identified by highlighting framelets with proximate locations as suspected duplicates.

## RESULTS

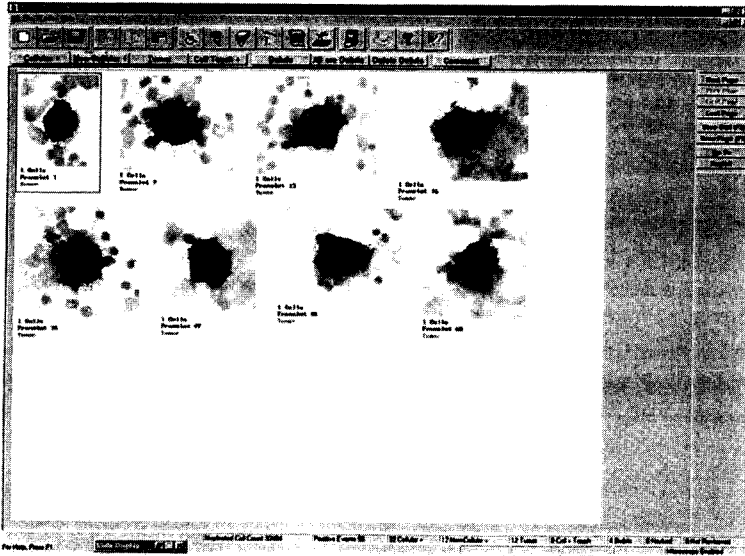
Figure 1 illustrates an example of a carcinoma cell identified from a bone marrow preparation obtained from a breast cancer patient. The specimen was immunocytochemically stained using the BM2 monoclonal antibody and enzymatically visualized in combination with fast red chromogen. The upper panel illustrates an example of positive immunocytochemical staining of a single tumor cell. Staining is evident on the plasma membrane and cytoplasm of the tumor cell but is absent in surrounding normal mononuclear bone marrow cells, which demonstrate only the blue hematoxylin nuclear counterstain. Using manual microscopy, OM analysis is conventionally performed following the laborious process of examining approximately  $10^5$  to  $10^6$  normal bone marrow mononuclear cells for the presence of 1 or more carcinoma cells.

In an effort to examine the feasibility for automating the OM assay, ACIS analysis was performed on the same bone marrow specimen. The lower panel of Figure 1 illustrates the result of ACIS analysis using an application that detects likely tumor cells based on the combination of presence of the red chromogen immunocytochemical staining and preset morphological characteristics (eg, range of nuclear size, nuclear shape). A laboratory professional next reviews the collected framelets to classify them as tumor cells or nontumor cells. In the case illustrated, 8 collected objects were reviewed and classified as tumor cells, representing the result following analysis of the entire bone marrow specimen. In addition, the ACIS counted approximately  $1.26 \times 10^6$  total mononuclear cells on

A



B



**Figure 1.** A, Example of a carcinoma cell in a bone marrow specimen obtained from a breast cancer patient. B, Result obtained after ACIS analysis of the entire bone marrow specimen and review of collected images. Analysis of this specimen resulted in the classification of 8 objects as tumor cells. ACIS analysis indicated a total mononuclear count of approximately  $1.26 \times 10^6$  cells on the specimen slide.

the specimen slide. ACIS analysis of this specimen required approximately 18 minutes.

To evaluate the sensitivity and specificity of the ACIS for tumor cell detection, known control populations were next evaluated. Bone marrow specimens were

**Table 1.** Specificity for Tumor Cell Detection Using ACIS-Assisted Analysis (Normal Bone Marrow vs. Bone Marrow Spiked With MDA-MB-468 Breast Carcinoma Cells)\*

	<i>Tumor Cell- Positive Cases</i>	<i>Tumor Cell- Negative Cases</i>	<i>Total Cases</i>
Bone marrow spiked with 4 + 3 breast carcinoma cells ( <i>n</i> = 10)	10	0	10
Bone marrow spiked with 51 + 8 breast carcinoma cells ( <i>n</i> = 10)	10	0	10
Normal bone marrow ( <i>n</i> = 10)	0	10	10
Total	20	10	30

\**Mononuclear cell preparations were from normal bone marrow specimens and bone marrow to which varying numbers (range, 1–59) of MDA-MB-468 breast carcinoma cells were added and immunocytochemically stained using an alkaline phosphatase–conjugated anti–pan-cytokeratin antibody (A45/BB3). Positive cells were visualized following incubation with the new fuchsin chromogen. The slides, each consisting of ~500,000 cells, were then analyzed using the ACIS. Specimens with 1 or more carcinoma cells were classified as tumor cell–positive.*

obtained from normal individuals (*n* = 10), specimens into which 1–7 in vitro human breast carcinoma cells (MDA-MB-468) were spiked (*n* = 10), and specimens spiked with 43–59 breast carcinoma cells (*n* = 10). Each of these specimens also included ~500,000 normal bone marrow mononuclear cells. The results of this study are shown on Table 1. No tumor cells were identified in any of the 10 normal bone marrow specimens analyzed. In contrast, 1 or more tumor cells was identified in each of the 20 specimens that were spiked with breast carcinoma cells.

Further studies were undertaken to evaluate and compare the OM review time as performed using the ACIS analysis vs. manual microscopy using these same specimens. For ACIS-assisted analysis, 2 elements contribute to the total analysis time: ACIS image scan and collect (in which the instrument performs analysis in an unattended fashion) and the ACIS-assisted review of montage images, which is performed by a laboratory professional. The overall ACIS scan and collect time was an average of 17.75 minutes (2.69 standard deviation [SD]), with a range of 14 to 25 minutes for the 30 specimens. The automated portion of the ACIS analysis for all specimens, therefore, was accomplished in a total of 8.9 hours. The total pathologist-assisted ACIS review of all montage images from the 30 specimens was accomplished in slightly less than 1 hour. This leads to a total ACIS analysis time (unattended scan and collect along with pathologist montage review) of 9.9

**Table 2.** Reproducibility Within and Between ACIS Instruments for Tumor Enumeration (Bone Marrow Specimens From Breast Cancer Patients)\*

<i>Instrument and Run Number</i>	<i>Specimen A, No. Positive Tumor Cells</i>	<i>Specimen B, No. Positive Tumor Cells</i>
Instrument 1		
1	7	18
2	7	18
3	7	18
4	7	18
5	7	18
Instrument 2		
1	7	18
2	7	18
3	7	18
4	7	18
5	7	18
Instrument 3		
1	7	18
2	7	18
3	7	18
4	7	18
5	7	18

\*Bone marrow mononuclear cell preparations from 2 breast cancer patients were fixed and immunoenzymatically stained using the BM2 monoclonal antibody and fast red chromogen. To examine the consistency of tumor cell detection and enumeration, each specimen was evaluated following analysis in 5 separate runs on each of 3 different ACIS instruments, for a total of 15 independent analyses per specimen.

hours. By contrast, manual microscopic evaluation of the 30 specimens required 11.9 hours, or an average of 23.8 minutes for each of the 30 specimens. Thus, using ACIS-assisted analysis, a reduction of approximately 11.9-fold in pathologist review time was accomplished, relative to analysis using manual microscopy.

Bone marrow specimens obtained from 5 breast cancer patients were subsequently analyzed in an effort to assess the reproducibility of ACIS-assisted analysis results. Table 2 illustrates the result of this analysis for 2 specimens in which 15 separate analyses were performed for each specimen. Each of 3 separate instruments was used to analyze each specimen, with 5 separate analyses per instrument. The data indicate that the ACIS identifies tumor cells in a highly reproducible fashion. Exactly the same number of tumor cells (as classified by the pathologist following the review of montage images) was identified for each specimen.

**Table 3.** Tumor Cell Detection: ACIS-Assisted Analysis vs. Manual Microscopy (Specimens From Breast Cancer Patients,  $n = 39$ )\*

ACIS-Assisted Analysis	Manual Microscopy	
	Tumor Cell-Positive Cases	Tumor Cell-Negative Cases
Tumor cell-positive cases	9	17
Tumor cell-negative cases	3	10
Total	12	27

\*Bone marrow specimens from 39 breast cancer patients were evaluated using both manual microscopy and ACIS-assisted analysis by 2 pathologists following immunoenzymatic staining with the BM2 monoclonal antibody and fast red chromogen. Manual microscopy and ACIS-assisted analysis agreed on 9 positive and 10 negative cases. In 20 cases, manual microscopy and ACIS-assisted analysis disagreed. In 17 of these cases, the specimen was classified as positive for tumor cells by ACIS-assisted analysis but negative for tumor cells by manual microscopy. (These discrepant cases were further investigated as described in Table 4.)

Three additional breast cancer bone marrow specimens were next analyzed on 3 separate ACIS instruments, with 3 independent runs per instrument. This analysis (data not shown) again revealed that exactly the same number of tumor cells was identified for each specimen in each run, with 23, 7, and 50 cells, respectively, consistently identified from each of 3 specimens.

The “montage compare” feature within the ACIS instrument displays multiple montage images of collected cells from separate instrument runs for review and comparison. Using this analysis tool, the reviewer determines whether identical cells are detected in different instrument runs. Reviewing the individual framelet images of all of the collected tumor cells from these 3 specimens revealed that, in all cases, not only the same number of tumor cells but also exactly the same tumor cells, were collected.

Additional studies were next performed using bone marrow specimens obtained from 39 breast cancer patients to further examine the performance of ACIS-assisted OM analysis vs. OM analysis by manual microscopy. For these studies, the specimens were evaluated by either of 2 pathologists, with independent evaluation performed using manual microscopy and ACIS-assisted analysis. The results of this study are shown in Table 3. In 7 of the 39 specimens (44%), the pathologist detected 1 or more tumor cells after ACIS-assisted analysis that were not detected by the same pathologist using manual microscopy.

Based on the fact that the ACIS data file includes  $x$  and  $y$  coordinates of each object that was classified in the original ACIS-assisted analysis, it was possible for the pathologist to recall all tumor cells for further studies. Each of the tumor cells

**Table 4.** Tumor Cell Detection Reproducibility: ACIS-Assisted Analysis vs. Manual Microscopy (Specimens From Breast Cancer Patients,  $n = 21$ )\*

Specimen	Number of Tumor Cells			
	Initial Analysis		Second Review	
	Manual Microscopy	ACIS-Assisted Analysis	ACIS Manual Analysis	ACIS-Assisted Analysis
1	0	0	0	0
2	0	2	2	2
3	0	1	1	1
4	0	2	2	2
5	0	1	1	1
6	0	4	4	4
7	0	1	1	1
8	0	2	2	2
9	0	0	0	0
10	0	1	2	1
11	0	1	1	1
12	0	3	3	3
13	0	2	2	2
14	0	0	0	0
15	0	5	5	5
16	0	1	1	1
17	0	2	2	2
18	0	0	0	0
19	0	4	4	4
20	0	2	2	2
21	0	3	3	3

\*The number of tumor cells counted from a total of 21 bone marrow specimens from breast cancer patients, which had initially been analyzed by both ACIS-assisted analysis and manual microscopy, were reevaluated. For 17 specimens that had originally been classified as tumor cell-negative by manual microscopy, a total of 37 objects were originally classified as tumor cells by ACIS-assisted analysis. These cells, along with 74 nontumor cells from the same 17 slides and 5 cells from each of 4 additional specimens (for a total of 131 cells), were recalled and reexamined by a pathologist who was blinded to the original ACIS-assisted cellular classification. Finally, the pathologist reviewed ACIS montage images a second time, again blinded to the original classification.

from the 17 disparate specimens (described above) was manually reevaluated using the binoculars available on the ACIS. To ensure objectivity, additional nontumor cells were also examined with all determinations blinded to the original cellular classification. The results of these studies are shown in Table 4. For all but 1 cell



(specimen 10), manual microscopic review led to findings that agreed with those obtained following the original ACIS-assisted analysis. For the 1 cell where a disparity was noted, the pathologist again reviewed both the original ACIS montage image and the specimen slide. The pathologist's conclusion, consistent with the original ACIS-assisted analysis, was that the disparate cell was not a tumor cell.

Finally, to verify the consistency of the ACIS-assisted analysis, the pathologist independently reviewed all ACIS montage images a second time, blinded to the original classification. The second ACIS-assisted analysis led to results that were identical to the original ACIS-assisted analysis (Table 4). From these findings, we conclude that the original discrepancy between ACIS-assisted analysis and manual microscopy reflected tumor cells that were not detected (ie, false negatives) by manual microscopy.

In 3 specimens, the original manual microscopic analysis (Table 3) led to the conclusion that tumor cells were present, whereas ACIS-assisted automated analysis revealed no detectable tumor cells. At a later date, the pathologist reanalyzed the specimen, blinded to the original interpretation. In an effort to optimize the reliability of the second read, the pathologist further reviewed the specimen slide for possible tumor cells at both conventional ( $\times 200$ ) and higher resolution ( $\times 400$ ) magnification. Following reanalysis, the pathologist concluded that none of the specimens included even 1 tumor cell—consistent with the original ACIS analysis but contrasting with the original analysis by manual microscopy. These findings indicate that the original manual microscopic analysis resulted in false-positive findings that were not observed by ACIS-assisted analysis.

## DISCUSSION

This study demonstrates that analysis of OM using immunocytochemical staining and analysis by the ACIS provides a sensitive, highly reproducible, and efficient means for OM detection and enumeration. Superior sensitivity for OM detection was demonstrated using ACIS-assisted analysis relative to manual microscopy. Specifically, in bone marrow specimens from 17 of 39 breast cancer patients in which the pathologist identified the presence of OM by ACIS-assisted analysis, the same pathologist incorrectly classified the specimen as negative after initial analysis by manual microscopy (Table 4). Analysis of the same specimen from breast cancer patients on multiple occasions, across multiple ACIS instruments, revealed excellent assay consistency (Table 2). Finally, an approximately 11.9-fold reduction in pathologist review time was achieved for analysis of 30 bone marrow specimens for OM using ACIS-assisted analysis relative to manual microscopy.

In addition to analysis by manual microscopy, 2 other methods are commonly employed for the analysis of OM today: flow cytometry and nucleic acid-based methods including reverse transcriptase-polymerase chain reaction (RT-PCR).

Flow cytometry represents an alternative technology that allows for the rapid analysis of tens of thousands of cells. The detection sensitivity of this methodology varies in published reports, but most commonly is reported to be in the range of approximately 1 cell in 10,000.<sup>22</sup> Other reports suggest a theoretical detection sensitivity in the range of approximately 1 cell in 200,000; even rarer cell types may be detectable.<sup>23,24</sup> The results of Gross et al.,<sup>24</sup> however, suggest that flow cytometric analysis of rare tumor cells (<1 cell in 100,000) leads to a detection sensitivity of only 10–40%. One key advantage for analysis by automated cellular imaging as opposed to flow cytometry is the fact that the analysis result is a cellular image. The use of a conventional counterstain (eg, hematoxylin) facilitates interpretation by a pathologist or other laboratory professional, leading to enhanced diagnostic certainty of the assay. Only with the use of tedious cell sorting methods (available on flow cytometry research instruments) can this type of interpretation be made using flow cytometry.

DNA-based nucleic acid methods for detecting OM analyze specific gene mutations, sequences of carcinogenic viruses, or other alterations specific to neoplastic cells.<sup>25</sup> This method holds considerable potential, but its true clinical relevance awaits confirmation in larger prospective studies. An alternative strategy for detecting OM in bone marrow specimens involves the use of RT-PCR to amplify specific mRNA molecules that are expressed in carcinoma cells but absent in normal cells. Although this approach holds considerable promise, it suffers from the fact that, for most cancer types, true tumor-specific mRNA molecules have not yet been identified. Inherent biological factors including the presence of pseudogenes or low-level expression of the targeted mRNA in normal cells can lead to false-positive test results using this method.<sup>26,27</sup> For example, “illegitimate expression” of cytokeratin 19 mRNA has been reported in peripheral blood.<sup>28</sup> In another study, 7 epithelial- and tumor-associated markers, including cytokeratin 18 mRNA, were amplified by RT-PCR in a significant percentage of bone marrow samples from noncancer patients,<sup>28</sup> illustrating the risk of false-positive results by this method. On the other hand, downregulation of a more specific carcinoma cell marker, such as prostate-specific antigen (PSA), in tumor cells may limit the sensitivity of RT-PCR in bone marrow from breast cancer patients,<sup>29</sup> possibly leading to false-negative interpretations.

One assay component of critical importance for the immunocytochemical detection of OM is the antibody reagent used for immunocytochemical staining. To date, a variety of antibodies have been used for the OM assay, which vary substantially in terms of sensitivity and specificity for carcinoma cell detection.<sup>12</sup> Antibodies used for OM detection have been reported to bind both specifically (eg, Fc-receptor-bearing leukocytes, illegitimate expression of epithelial antigens in normal hematopoietic cells) and nonspecifically in cells including macrophages, plasma cells, and nucleated erythroid precursors.<sup>30–33</sup> The use of antibodies with

well-documented specificity for carcinoma cells, as opposed to normal hematologic mononuclear cells (eg, A45/BB3, A45/BB5), is highly advantageous for a robust OM assay. In addition, careful morphologic assessment, along with proper interpretation of immunocytochemical staining, appears imperative to ensure that immunocytochemically stained cells are, in fact, tumor cells,<sup>34</sup> as opposed to leukocytes and other nonneoplastic cells. By providing cellular images with counterstains conventionally used for cellular diagnostic purposes, along with the capability to revisit the cell on the microscope slide, the ACIS provides the opportunity for cellular classification with increased diagnostic certainty relative to the alternative methods discussed above.

In conclusion, these studies demonstrate that ACIS-assisted analysis combined with immunocytochemical staining offers the possibility of sensitive and reliable assessment of OM. Prospective studies now appear important to further explore the true clinical significance of this assay.

### ACKNOWLEDGMENTS

The authors wish to recognize the tireless, dedicated efforts of M. Watson, M. Schneider, and P. Hays in coordinating the execution of the study and A. Turriago for outstanding technical assistance. We further thank D. Williams, M. Boggy, and C. Caron for assistance in preparation and editing of the manuscript.

### REFERENCES

1. Cote RJ, Rosen PP, Lesser ML, et al. Prediction of early relapse in patients with operable breast cancer by detection of occult bone marrow micrometastases. *J Clin Oncol* 9:1749-1756, 1991.
2. Diel IJ, Kaufmann M, Goerner R, Costa SD, Kaul S, Bastert G. Detection of tumor cells in bone marrow of patients with primary breast cancer: a prognostic factor for distant metastases. *J Clin Oncol* 10:1534-1539, 1992.
3. Diel IJ, Kaufmann M, Costa SD, et al. Micrometastatic breast cancer cells in bone marrow at primary surgery: prognostic value in comparison with nodal status. *J Natl Cancer Inst* 88:1652-1658, 1996.
4. Harbeck N, Untch M, Pache L, Eiermann W. Tumor cell detection in the bone marrow of breast cancer patients at primary therapy: results of a 3-year median follow-up. *Br J Cancer* 69:566-571, 1994.
5. Braun S, Pantel K, Muller P, et al. Cytokeratin-positive cells in the bone marrow and survival of patients with stage I, II, or III breast cancer. *N Engl J Med* 342:525-533, 2000.
6. Lindemann F, Schlimok G, Dirschedl P, et al. Prognostic significance of micrometastatic tumor cells in the bone marrow of colorectal cancer patients. *Lancet* 340:685-689, 1992.
7. Pantel K, Izbicki JR, Angstwurm M, et al. Immunocytological detection of bone marrow micrometastases in operable non-small cell lung cancer. *Cancer Res* 53:1027-1031, 1993.

8. Thorban S, Rode JD, Neharda H, et al. Immunocytochemical detection of disseminated tumor cells in the bone marrow of patients with esophageal cancer. *J Natl Cancer Inst* 88:1222–1227, 1996.
9. Singletary SE, Larry L, Tucker S, et al. Detection of micrometastatic tumor cells in bone marrow of breast carcinoma patients. *J Surg Oncol* 47:32–36, 1991.
10. Molino A, Pelosi G, Turazza M, et al. Bone marrow micrometastases in 109 breast cancer patients: correlations with clinical and pathological features and prognosis. *Breast Cancer Res Treatment* 42:23–30, 1997.
11. Funke I, Schraut W. Meta-analysis of studies of bone marrow micrometastases: an independent prognostic impact remains to be substantiated. *J Clin Oncol* 16:557–566, 1998.
12. Braun S, Pantel K. Prognostic significance of micrometastatic bone marrow involvement. *Breast Cancer Res Treatment* 52:201–216, 1998.
13. Pantel K, Cote RJ, Fodstad O. Detection and clinical importance of micrometastatic disease. *J Natl Cancer Inst* 91:1113–1124, 1999.
14. Borgen E, Naume B, Nesland JM, et al. Standardization of the immunocytochemical detection of cancer cells in bone marrow and blood. *J Hematother*. In press.
15. Mansi JL, Mesker WE, McDonnell T, et al. Automated screening of bone marrow smears for micrometastasis. *J Immunol Methods* 112:105–111, 1988.
16. Mesker WE, van den Burg MJM, Oud PS, et al. Detection of immunocytochemically stained rare events using image analysis. *Cytometry* 17:209–215, 1994.
17. Kraeft S, Sutherland R, Gravelin L, et al. Detection and analysis of cancer cells in blood and bone marrow using a rare event imaging system. *Clin Cancer Res* 6:434–442, 2000.
18. Beahrs OE, Henson DE, Hotter RU, Myers MH. *Manual for Staging of Cancer*. 3rd ed. Philadelphia, PA, Lippincott, 1988.
19. Bastert G, Eichler A, Kaul S. Monoclonal antibodies against breast cancer. In: Rygaard, Brunner, Spang-Thomsen, eds. *Immune Deficient Animals in Biomedical Research*. Basel, Switzerland, Karger, 1987, p. 224–227.
20. Kaul S, Windecker S, Bastert G. Monoclonal antibodies reactive with tumor-associated epitopes of breast mucin glycoproteins. *Proc Am Assoc Cancer Res* 30:349, 1989.
21. Brummendorf TH, Kaul S, Schuhmacher J, et al. Immunoscintigraphy of human mammary carcinoma xenografts using monoclonal antibodies 12H12 and BM-2 labeled with <sup>99m</sup>Tc and radioiodine. *Cancer Res* 54:4162–4168, 1994.
22. Clevenger CV, Khandewal M, Stadtmauer E, Jardines L. Detection of bone marrow breast carcinoma metastasis using multiparameter flow cytometry. *Ann N Y Acad Sci* 677:400–401, 1993.
23. Ryan D, Mitchell SJ, Hennessey LA, et al. Improved detection of rare CALLA-positive cells in peripheral blood using multiparameter flow cytometry. *J Immunol Methods* 74:115–128, 1984.
24. Gross HJ, Verwer B, Houck D, et al. Model study detecting breast cancer cells in peripheral blood mononuclear cells at frequencies as low as 10<sup>7</sup>. *Proc Natl Acad Sci U S A* 92:537–541, 1995.
25. Pantel K, Knebel Doeberitz M. Detection and clinical relevance of micrometastatic cancer cells. *Curr Opin Oncol* 12:95–101, 2000.
26. Ghossein RA, Bhattacharya S, Rosai J. Molecular detection of micrometastases and cir-

- culating tumor cells in solid tumors. *Clin Cancer Res* 4:1950–1960, 1999.
27. Raj GV, Moreno JG, Gomella LG. Utilization of polymerase chain reaction technology in the detection of solid tumors. *Cancer* 82:1419–1442, 1998.
  28. Krismann M, Todt B, Schroder J, et al. Low specificity of cytokeratin 19 reverse transcriptase-polymerase chain reaction analyses for detection of hematogenous lung cancer dissemination. *J Clin Oncol* 13:2769–2775, 1995.
  29. Zippelius A, Kufer P, Honold G, et al. Limitations of reverse transcriptase polymerase chain reaction for detection of micrometastatic epithelial cells in bone marrow. *J Clin Oncol* 15:2701–2708, 1997.
  30. Pantel K, Schlimok G, Braun S, et al. Methodological analysis of immunocytochemical screening for disseminated epithelial tumor cells in bone marrow. *J Hematother* 3:165–173, 1995.
  31. Thor A, Viglione MJ, Ohuchi N, et al. Comparison of monoclonal antibodies for the detection of occult breast carcinoma metastases in bone marrow. *Breast Cancer Res Treatment* 11:133–145, 1988.
  32. Borgen E, Beiske K, Trachsel S, et al. Immunocytochemical detection of isolated epithelial cells in bone marrow: non-specific staining and contribution by plasma cells directly reactive to alkaline phosphatase. *J Pathol* 185:427–434, 1998.
  33. Diel IJ, Cote RJ. Bone marrow and lymph node assessment for minimal residual disease in patients with breast cancer. *Cancer Treatment Rev* 26:53–65, 2000.
  34. Werner W, Nasarek A, Georg A II. Isolated tumor cells in the bone marrow: value of a new diagnostic method in the TNM-staging of solid tumors. *Gen Diag Pathol* 142:1–6, 1996.



# **CHAPTER 16**

## **SUMMARIES**





# **Hematologic Malignancies: Summary**

**John Barrett**

*Stem Cell Allotransplantation Section, Hematology Branch, National Heart, Lung, and Blood Institute, National Institutes of Health, Bethesda, Maryland*

## **MINI-TRANSPLANTS**

At this meeting, much new data were presented on the use of nonmyeloablative “mini-transplants.” Reports from the M.D. Anderson, Jerusalem, National Institutes of Health (NIH), Boston, and Seattle groups demonstrate that this approach can be applied in older and debilitated patients with low or at least acceptable transplant-related mortality, as well as in those with mismatched donors. Furthermore, the ability of the mini-transplant to confer graft-vs.-malignancy effects has now been demonstrated in B-cell and myeloid malignancies, as well as in renal cell cancer. Several treatment approaches are being developed that will require more prospective studies to fully evaluate their relative merits. Clearly, this field has given a boost to the concept of a powerful alloimmune response to malignancy that can be harnessed and applied in diseases and recipients not previously studied.

## **LEUKEMIAS**

### **Old Questions, Some New Answers**

In the treatment of acute leukemias, questions that concern the relative benefit for competing approaches never appear to be resolved, largely because the field moves ahead faster than comparative trials can keep up with the advances. This was illustrated by reports of several comparative studies—autologous vs. allogeneic transplants, autologous transplant vs. chemotherapy, bone marrow vs. peripheral blood as the stem cell source—and perennial questions concerning the role of purging. Some answers to these dilemmas were, however, forthcoming.

### **Acute Lymphoblastic Leukemia**

In acute lymphoblastic leukemia (ALL) in first remission, autologous bone marrow transplantation (autoBMT) does seem to hold some advantage over the best current chemotherapy for adults. Daniel Weisdorf (University of Minnesota),

presenting data from the registries of the Autologous Blood and Marrow Transplant Registry and the National Marrow Donor Program, showed that in certain circumstances autoBMT also appeared to be more likely to result in disease-free survival than an allograft from an unrelated donor. In second-remission ALL, autoBMT still appears to be disappointing, with a prohibitively high relapse rate. The study by Weisdorf indicated that the unrelated donor transplant with its superior antileukemic effect resulted in better disease-free survival. Likewise for Philadelphia chromosome (Ph)-positive ALL: Jorge Sierra (Hospita Sant Pau, Barcelona, Spain) presented convincing data that allograft, not autograft, in first remission produced the highest chance of cure.

### **Acute Myeloblastic Leukemia**

The results of autoBMT from the Johns Hopkins group presented by Carole Miller indicated disappointingly low survivals, but with a possible role for *in vitro* purging with 4-hydroperoxycyclophosphamide (4HC) for acute myeloblastic leukemia (AML) in second remission. More promising may be the concept of *in vivo* purging where the autograft is collected after intensive therapy, as presented by Charles Linker (University of California–San Francisco). *In vivo* purged autologous transplants appear to be better tolerated than *in vitro* purged transplants and deserve further exploration. Autologous transplantation may hold out some hope for patients with AML developing from myelodysplastic syndrome (MDS). Multicenter study results presented by Peter Muus (University of Nijmegen, The Netherlands) indicated that induction chemotherapy and autoBMT are superior to chemotherapy alone and can produce prolonged survival in a minority of patients with MDS or secondary AML—modest but real improvements for a salvage therapy in this poor-prognosis situation. It is hoped that some of the new insights into the complicated pathophysiology of MDS (presented by Azra Raza, Rush Cancer Institute, Chicago, IL)—which involves an intrinsic defect in the stem cell leading to both apoptosis and unregulated proliferation and an extrinsic process involving the marrow stroma and the immune system—may lead to alternative approaches to stem cell transplantation, which suffers from high transplant-related mortality and lack of a good antileukemic effect.

### **Chronic Myelogenous Leukemia**

The specific BCR-ABL tyrosine kinase inhibitor, STI571, developed by Brian Druker (Oregon Health Sciences University, Portland, OR) takes center stage as the most significant breakthrough in treatment developments for chronic myelogenous leukemia (CML) and, potentially, in treatment results. In light of the ability of STI571 to achieve results at least as good as those of interferon but with minimal

side effects, new trials will need to be developed to reassign the place of autologous and allogeneic stem cell transplantation in CML. In the meantime, the study by Angelo Carella (Ospedale San Martino, Genova, Italy) provides support for the potential of autoBMT using Ph<sup>-</sup> CD34 cells to produce prolonged suppression of the Ph<sup>+</sup> clone, superior to that achievable by interferon. It is tempting to think that the combination of STI571 with autografting or allografting may be the way to optimize the rate of molecular cures in CML.

### **Blood vs. Bone Marrow**

The attraction of peripheral blood stem cell transplants (PBSCT) in AML is particularly the perception that the peripheral blood might result in better hematologic reconstitution than the notoriously slow recovery seen after some autoBMTs for AML. N.C. Gorin (Hopital St. Antoine, Paris, France) presented results of large numbers of autoBMTs from the European Group for Blood and Marrow Transplantation (EBMT) in AML that showed, surprisingly, that relapse rates were higher with PBSCT. This study identified the colony-forming unit-granulocyte/macrophage (CFU-GM) content of the transplant (whether blood or marrow derived) as the main determinant of outcome and recovery. This large analysis spanning more than a decade of data illustrated again how results have a habit of improving without a discernible reason other than what can be ascribed to "the learning curve." Thus, the outcome for autoBMT, whether using blood or marrow, from 1994 onward was superior to earlier data. In the absence of completed prospective studies, it is not yet clear whether PBSCT outcomes will differ significantly from those of BMT. In allogeneic transplantation, interestingly, despite the earlier perceptions that PBSCT results in better outcomes, there is no clear picture emerging that PBSCT is always superior to BMT. Similarly, more data will be required before the relative benefits of CD34-selected vs. unselected peripheral blood allografts can be determined.

### **Acute Leukemia Transplantation: Where Next?**

In summary, results of allografts and autografts continue to improve, and older patients are being transplanted with increasing success. However, the problem facing our current transplant approaches in acute leukemia can be summarized thus: The success of the allograft is limited by high transplant-related mortality (TRM), while a high relapse rate limits the efficacy of the autograft. Possible solutions to this impasse are offered by the mini-transplant approach, which appears to impose on older and debilitated patients a TRM no greater than that encountered by younger, fitter patients. What we do not yet know is whether mini-transplants will further reduce TRM and result in cure of leukemia in the cohort of

patients currently receiving standard allotransplants. At the same time as the preparative regimen intensity in mini-transplants is being reduced to permit engraftment of alloreactive cells to exert a graft-vs.-leukemia effect, other investigators are beginning to produce good results with dose-intensified pretransplant regimens that differ from the historical intensified regimens by being much more leukemia specific, or at least marrow specific, in their toxicity. Notably, promising results were reported with radioimmunoconjugates [ $^{131}\text{I}$ ]CD45, [ $^{131}\text{I}$ ]CD33, [ $^{90}\text{Y}$ ]antiferritin, and [ $^{186}\text{Re}$ ]CD66 used to deliver a high and marrow-directed radiation dose. These intensified preparative regimens could find an application in both autologous and allogeneic transplants. As an alternative approach to improve the antileukemic effect of the autograft, immunomodulation with interleukin (IL)-2 to potentiate immune reactivity against the residual leukemia still appears to be the most interesting strategy: Anthony Stein (City of Hope, Duarte, CA) reported a low 24% relapse and a high 75% disease-free survival (DFS) rate in patients with AML given IL-2. These results justify more studies with IL-2.

## LYMPHOID MALIGNANCIES

### Hodgkin's Disease

Despite the overall improvement in the treatment of Hodgkin's disease, extensive or relapsed disease still represents a major problem, with high death rates from treatment failure and secondary MDS. Many questions remain unresolved for these patients. For example: What is the role of radiotherapy? Should second-line or third-line salvage therapy be given before autoBMT? What is the place of the mini-allograft? What are the risk factors for MDS? Patients relapsing or with refractory Hodgkin's disease after front-line chemotherapy currently either undergo salvage chemotherapy treatments followed by an autograft or go directly to high-dose treatment with an autograft. The "testing" for disease responsiveness with second-line therapy before proceeding to autoBMT may predispose to a greater incidence of MDS, and its logic was challenged by John Sweetenham (University of Colorado Health Sciences Center, Denver, CO), who reported no survival advantage in 2 studies of patients who received second-line therapy before autograft. A definitive study to resolve this question remains to be done. The advance of mini-transplants into the field of autograft failures provides new information on the alloresponse to Hodgkin's disease conferred by the mini-transplant. Data are still preliminary but suggest that the low-intensity mini-allograft may offer a useful form of salvage therapy in Hodgkin's disease, begging the question whether the allograft should be evaluated as curative treatment earlier in the disease. Another continuing problem in Hodgkin's disease is the development of secondary MDS, often, tragically, in patients cured of their original malignancy. Unfortunately, with increased ability to

cure relapsing Hodgkin's disease by second- and third-line therapy or autologous transplant, the risk of MDS increases. Attempts to reduce the intensity of the conditioning of the autograft are important in minimizing the risk.

### **Non-Hodgkin's Lymphoma**

In relapsed non-Hodgkin's lymphoma (NHL), the place of autoBMT appears increasingly secure, especially in intermediate-grade lymphoma. Less certain is the value of autoBMT in refractory NHL. The well-tolerated ICE regimen (ifosfamide, carboplatin, and etoposide) results in efficient stem cell mobilization and has facilitated further studies in this area. Interestingly, although an allo-effect against lymphoma can be demonstrated, a large study by the EBMT shows that autotransplantation produces superior DFS, again because of the high TRM following allogeneic transplantation. Currently, there seems to be little place for allogeneic stem cell transplant (SCT) in NHL, except in mantle cell lymphoma, where both allogeneic and autologous SCT appear promising. Future developments in the treatment of NHL are likely to emerge in 2 areas. First, new monoclonal antibodies such as rituximab, with or without radioconjugation, promise to make significant improvements in the treatment of relapsed or refractory NHL. Second, the high TRM from allografts, especially when used as salvage treatment in NHL, may now be reduced by the use of the mini-transplant, and current reports show that the mini-allotransplant may be particularly effective in B-cell malignancies.

### **Multiple Myeloma**

Progress in multiple myeloma (MM) is slow. The disease usually becomes refractory to treatment and is not readily cured by allografts, which have a notoriously high mortality. The results of mini-allotransplants in MM, while promising, still have a high TRM. Autologous SCT has produced remissions and has prolonged survival and, if tolerated, the double transplant approach does appear to be better than a single transplant. We have also learned that posttransplant treatment, whether with interferon or chemotherapy, is better than none at all. For the future, we look to improved results with low-intensity allografts, biological therapies to attack the stromal support for myeloma cell proliferation with thalidomide and VEGF inhibitors, and immunotherapy using dendritic cells as vaccines to deliver myeloma antigens to the immune system.

### **CONCLUSIONS**

What next? Space does not permit a full review of the presentations at this meeting that shed new insight into stem cell biology. Suffice it to draw attention to

the improvements in stem cell transduction presented by John Tisdale (National Institutes of Health), which should make reliable gene therapy using stem cells a practical possibility. This is all the more exciting because of the emerging concept that some stem cells are transmutable, making possible the chance of correcting tissues other than the marrow with gene therapy. In the field of immunotherapy, further developments with monoclonal antibodies, dendritic cell vaccines, and cytokines can be anticipated. The demonstration, with the creation of STI571, that molecular design strategies can produce such dramatic results will surely give a huge impetus to the application of similar techniques to create molecules that block other known key molecular pathways in the malignant process.

# **The Tenth International Symposium on Autologous Blood and Marrow Transplantation Summary: Solid Tumors**

***Patrick J. Stiff***

*BMT Program, Loyola University Medical Center, Maywood, Illinois*

It has become common practice in oncology to demonstrate in phase 3 trials that new treatments are superior to standard therapies before they can be accepted as standard of care. This, the Tenth International Symposium on Autologous Blood and Marrow Transplantation, marks the first time phase 3 data were presented documenting a statistical benefit to autologous transplantation in patients with solid tumors, specifically neuroblastoma, and (preliminarily) in early-stage high-risk breast cancer. Additional data were presented suggesting that transplants may also be proven appropriate for certain patients with stage IV breast cancer, testes cancer, and advanced ovarian carcinoma before the next meeting in 2002. Also for the first time, data were presented that appear to validate a graft-vs.-tumor effect from an allogeneic stem cell transplant in selected solid tumors. G. Elfenbein, in his introductory remarks to the Breast Cancer Session, discussed the issue of end points, study designs, and the differences in statistical vs. medical benefit. For phase 3 transplant trials, it is critical to clearly delineate end points. Whereas it has been assumed that transplants should be done only when an improvement in the cure rate can be shown, a lack of improvement in the median survival of patients undergoing transplant may still be associated with a survival benefit, provided there is sufficient follow-up. Such appears to be the case for the US Cancer and Leukemia Group B (CALGB)-led phase 3 high-risk stage II/III breast cancer trial, as a statistically higher relapse rate, already evident, would not be associated with a higher death rate for several years, given the effectiveness of conventional salvage therapy.

The Breast Cancer Session was initiated by an extensive review of the status of European trials by G. Rosti, head of the European Group for Blood and Marrow Transplantation (EBMT) Solid Tumor Working Party. Of the more than 6500 patients reported to the EBMT, 3000 were for stage IV disease and of these, ~430 patients were transplanted in complete remission (CR). Confirming the data seen in Peters' initial phase 3 study and subsequent Autologous Blood and Marrow Transplant Registry data, he reported that ~50% of this group was progression free at 6 years. In the adjuvant setting for stage II/IIIA disease, the 5-year disease-free

survival was 52.5%, with a median progression-free survival of 42 months in stage IIIB disease. Randomized studies involving up to 4000 patients, including several trials in stage IV disease, are under way or nearing completion, with data available in 2002. Subsequent presenters in the Breast Cancer Session (Fields, Martinelli, and Dicke) discussed novel regimens, including high-dose topotecan for the first time, and updated single-institution data on multicycle high-dose therapy. Using several cycles of CVP chemotherapy (cyclophosphamide, etoposide, and cisplatin) followed by MTB (mitoxantrone, thiotepa, and BCNU) with stem cells and maintenance chemotherapy administered intermittently for several years in patients with stage IV disease, K. Dicke noted impressive survival statistics, with a projected 5-year survival of 90% in patients treated with minimal residual disease (MRD). His conclusion, that maintenance therapy following transplant may have a significant impact on long-term survival, deserves further study. Taken together, these data suggest that, in contrast to the US Philadelphia Bone Marrow Transplant (PBT-1) trial, patients with stage IV breast cancer with MRD should be considered for transplant. Phase 3 data to determine survival benefit should be available soon.

S. Rodenhuis reported preliminary results of the phase 3 National Cancer Institute (NCI)-Netherlands trial of dose-intensive CTC (carboplatin, thiotepa, and cyclophosphamide) vs. no consolidation therapy for patients with high risk stage II and III disease. Although data for the entire 885-patient cohort will not be available until 2002, the results of a government-required interim analysis of the first 284 patients indicated an absolute 15% improvement in progression-free survival ( $P=.009$ ) and a 10% increase in overall survival ( $P=.039$ ) for the high-dose group. In addition, for the entire group of 885 patients, there appears to be an early (3-year) difference in progression-free survival of 72% vs. 65% ( $P=0.57$ ). S. Gluck reported an update of the NCI Canada Trial (MA.16) for stage IV disease which began in 1997 and is ongoing (213 enrolled of a planned 300 patients). Patients are randomized after 4 cycles of conventional chemotherapy to either a single course of high-dose therapy vs. observation or additional conventional chemotherapy at the discretion of the investigator. Again, unlike the US PBT-1 trial, more patients are alive than would have been expected based on previous studies of conventional chemotherapy for this patient group (58% survival at 2 years). This suggests that a more chemotherapy-sensitive group is being treated in Canada than was treated in the US PBT-1 trial. With data indicating that transplant for stage IV disease is optimal in exquisitely chemosensitive disease, this trial will be extremely important in determining the value of transplant in this patient group.

In addition to posttransplant chemotherapy, several investigators reported on the potential role of immune therapy after transplant including anti-CD3, interleukin (IL)-2-activated T cells (L. Lum), and peptide-pulsed dendritic cells (P. Brossart). Enhanced *in vitro* and *in vivo* immunoreactivity have been seen in these studies, but it is too early to measure clinical benefit. With 70%–80% of



patients relapsing after transplant for stage IV disease despite MRD status, and with 30% of patients with stage II and IIIA disease relapsing, the value of posttransplant chemotherapy, antibody therapy, or cellular immune therapy will need to be evaluated in the next generation of phase 3 trials, once the precise role of standard transplant is defined for each of the various stages.

For less common solid tumors (primary central nervous system [CNS] and small-cell lung cancer), phase 3 US trials are not being considered or planned; the EBMT is conducting a trial in small-cell lung cancer. Data from the largest US center performing transplants for small cell lung cancer (A. Elias) suggested that for limited-stage disease, a 5-year survival of 50%–55% could be expected. However, this is not dissimilar to conventional aggressive regimens of concomitant chemoradiotherapy for this patient group. An extensive review of US transplant trials for primary CNS tumors was presented by S. Gardner. Whereas there is limited value for transplant in newly diagnosed glioblastoma multiforme and diffuse pontine tumors, she presented data suggesting a benefit to transplantation for medulloblastoma, ependymoma, primitive neuroectodermal tumor, and oligodendrogliomas. Data are emerging to suggest that, for those undergoing transplantation, radiotherapy can be eliminated as part of primary therapy for CNS tumors in infants.

Several reports of the potential value of transplantation in advanced ovarian carcinoma were presented, as well as updates of ongoing and phase 3 planned trials in the US and Europe. J. Ledermann presented an EBMT registry analysis that strongly suggests the benefit of transplant in CR1 patients, including an approximately 40% long-term survival for patients with stage IV disease. He reviewed the ongoing OVCAT (Ovarian Cancer Trial), which tests multicycle high-dose therapy in lieu of conventional therapy. P. Stiff reviewed the alternative strategy, ie, transplanting responding patients in CR1. Data from Loyola and from several French centers, including a 181-patient retrospective analysis, suggest both a progression-free and overall survival benefit of approximately 1 year for patients undergoing transplant. The GINECO (French) Trial was to complete accrual in 2000 with initial results presented in 2002 for patients with advanced ovarian carcinoma who respond to initial combination chemotherapy.

G. Rossi reviewed the EBMT database for testicular cancer and updated ongoing European trials. Based on several European phase 2 studies, the International Trial began in 1994 for patients in first partial remission or relapse after CR, with patients randomized to receive either 4 courses of salvage chemotherapy or 3 courses followed by a single transplant. Accrual is nearly complete. This study should help define the value of transplant for relapsing patients. Transplant outcome in this group is expected to yield a 40% survival at 3 years with no relapses seen after 20 months, based on the EBMT database, and a suggested benefit compared with conventional chemotherapy alone of ~10%. Finally, J. Villablanca reviewed the phase 3 Children's Cancer Group (CCG) trial data for high-risk advanced neurob-

lastoma, which demonstrated a survival benefit to patients receiving a purged autograft, and the further clinical benefit to *cis*-retinoic acid maintenance that was published recently in the *New England Journal of Medicine*, and discussed ongoing plans for this patient group. The next phase 3 trial will evaluate the use of peripheral blood progenitor cells in lieu of purged bone marrow. Patients will be randomized to receive purged or unpurged peripheral blood progenitor cells. After transplant, a second randomization to *cis*-retinoic acid with or without anti-GD2 antibody with granulocyte-macrophage colony-stimulating factor and IL-2 will be performed to determine if additional immune modulation further improves outcome for patients with high-risk neuroblastoma.

Although the concept of graft-vs.-tumor has been well described for several decades, it was not successfully applied to the management of solid tumors until very recently. Using the concept of submyeloablative transplants, the team from the National Institutes of Health reported the results of a series of 74 patients treated with high-dose cyclophosphamide and fludarabine and allogeneic peripheral blood stem cells and T cells. Graft-vs.-host disease (GVHD) prophylaxis was primarily with cyclosporine and tapered after day 30 as soon as full T-cell chimerism was established. Forty-four patients had solid tumors, including 32 with renal cell cancer and 8 with melanoma. Whereas 0 of 8 patients with metastatic melanoma responded, 11 of 32 patients with renal cell cancer responded, and 16 are currently alive. Of the 11, 4 had a complete remission and 7 a partial remission. The concept of an immunoablative preparative regimen with high CD34<sup>+</sup> and CD3<sup>+</sup> cell doses and minimal immunosuppression to increase the graft-vs.-tumor effect, with the goal of achieving full T-cell chimerism, appears promising in the management of renal cell carcinoma and may be of value in melanoma, but perhaps not in patients with metastatic disease. A note of caution needs to be sounded, as it was found that there were 4 treatment-related deaths among the 32 solid-tumor patients and an overall 36% mortality for patients above the age of 48 years, usually due to GVHD.

In the final session, the timeless topic of tumor cell contamination of autografts was once again considered. Several presenters described again the significance of marrow and/or stem cell tumor cell contamination on survival after transplant. Using more sensitive assays, up to 25%–30% of patients with stage II and III and 40%–70% of patients with stage IV disease will have detectable tumor cells in the peripheral blood stem cell autografts. However, it was generally agreed that purging is unlikely to be worthwhile unless 4 to 5 logs of tumor cells are depleted, and current methods that are available to reach these levels also lead to a significant depletion of CD34<sup>+</sup> stem cells. Nevertheless, most of the presenters felt that purging studies in patients with high-risk stage II and III breast cancer are still warranted, with effective purging a potential benefit in delaying or decreasing relapses in this patient population.

While enthusiasm waned after the 1999 American Society of Clinical Oncology plenary session for solid tumor transplants as measured by new patient referrals in the US, overall it was thought by all of the presenters that studies in both autologous and allogeneic transplantation are still needed in the solid tumor setting, especially given the minimal progress made with conventional-dose therapy. As stated above, even for metastatic or otherwise incurable disease, the achievement of a minimal residual disease state serves as a platform for posttransplant consolidation by vaccines and other immune therapies, or even maintenance chemotherapy.

## LIST OF PARTICIPANTS

Bassim Al-Beirouti  
Princess Margaret Hospital  
1330 Mississauga Valley Blvd  
Mississauga, Ontario  
Canada L5A 3T1

Hamad Al-Omar  
King Faisal Specialist Hospital  
Oncology  
Takhassussi St.  
Riyadh, Saudi Arabia 11211

Kenneth Anderson  
Dana Farber Cancer Institute  
Adult Oncology  
44 Binney St.  
Boston, MA 02115

Joseph Antin  
Dana-Farber Cancer Institute  
44 Binney St.  
Boston, MA 02115

Jane Apperley  
Imperial College School of Medicine  
Hammersmith Hospital  
DuCane Rd.  
London, UK W12 0NN

A. John Barrett  
National Heart, Lung and Blood  
Institute  
Hematology Branch  
10 Center Dr., MSC 1652  
Bethesda, MD 20892-1652

Philip Bierman  
University of Nebraska Medical Center  
Oncology/Hematology  
987680 Nebraska Medical Center  
Omaha, NE 68198-7680

Wolfram Brugger  
University of Tübingen Medical Center  
Hematology/Oncology/Immunology  
Otfried-Mueller Str. 10  
Tübingen, Germany 72076

Richard Burt  
Northwestern University  
Hematology/Oncology Department  
250 E. Superior  
Chicago, IL 60611

Angelo Carella  
Ospedale San Martino  
Hematology/ABMT Unit  
Via Acerbi 10-22  
Genova, Italy 16148

Justiniano Castro  
UPR School of Medicine  
Hematology/Oncology  
425 Carr 693, Box 371  
Dorado, Puerto Rico 00646

Raj Chopra  
Christie Hospital/Patterson Institute  
for Cancer  
Experimental Hematology  
Wilmslow Rd.  
Manchester, UK M20 2QT

Robert Collins, Jr.  
UT Southwestern Medical Center  
Internal Medicine  
5323 Harry Hines Blvd.  
Dallas, TX 75390-8590

M. Corsetti  
Ospedale San Martino  
Hematology/ABMT Unit  
Via Acerbi 10-22  
Genova, Italy 16148

Michael Crump  
Princess Margaret Hospital  
Medical Oncology  
600 University Ave.  
Toronto, Ontario, Canada M56 2M9

Ugo De Giorgi  
City Hospital-Ravenna  
Oncology and Hematology  
Viale Randi 5  
Ravenna, Italy 48100

Javier de la Rubia  
University Hospital La Fe  
Hematology Service  
Avda Campanar, 21  
Valencia, Spain 46009

Mary Dibley  
University of Rochester  
Bone Marrow Transplant  
601 Elmwood Ave.  
Rochester, NY 14642

Karel Dicke  
Arlington Cancer Center  
High Dose Chemo/BMT  
906 West Randol Mill Rd.  
Arlington, TX 76012

Craig Dorrell  
The Hospital for Sick Children  
Blood and Cancer  
555 University Ave.  
Toronto, Ontario, Canada M5G 1X8

Luc Douay  
Hopital Trousseau  
Hematology  
26 Ave du Dr. Netter  
Paris, France 75012

Brian Druker  
Oregon Health Sciences University  
Hematology/Oncology  
3181 SW Sam Jackson Park Rd.  
Portland, OR 97201-3098

Gerald Elfenbein  
Roger Williams Medical Center  
825 Chalkstone Ave.  
Providence, RI 02908

Anthony Elias  
Dana-Farber Cancer Institute  
Adult Oncology  
44 Binney St.  
Boston, MA 02115

Athanasios Fassas  
George Papanicolaou Hospital  
Department of Haematology  
570 10 Exokhi  
Exokhi-Thessaloniki, Greece 57010

Karen Fields  
H Lee Moffitt Cancer Center  
Oncology  
12902 Magnolia Dr.  
Tampa, FL 33612

Cesar Freytes  
 University of Texas Health Science  
 Center  
 Medicine/Hematology  
 7703 Floyd Curl Dr.  
 San Antonio, TX 78229-3980

Gosta Gahrton  
 Huddinge Hospital  
 Department of Medicine and  
 Hematology  
 Karolinska Institutet  
 Stockholm, Sweden 14186

Laurent Garderet  
 Hopital Saint-Antoine  
 Service des Maladies du Sang  
 184 rue du Faubourg Saint-Antoine  
 Paris, France 75012

Sharon Gardner  
 New York University  
 Pediatric Oncology  
 317 E 34th St.  
 New York, NY 10016

Adrian Gee  
 Baylor College of Medicine  
 Cell and Gene Therapy  
 1102 Bates, C1140  
 Houston, TX 77030

Stefan Gluck  
 Tom Baker Cancer Centre  
 Oncology, Medicine, Pharmacy and  
 Therapeutical  
 1331-29 St., NW  
 Calgary, Alberta, Canada T2N 4N2

Norbert Claude Gorin  
 John Hopkins Oncology Center  
 1650 Orleans St.  
 Baltimore, MD 21231

Terry Hamblin  
 University of Southampton  
 Tenovus Laboratory  
 Southampton University Hospital Trust  
 Southampton, UK SO16 6YD

Jean-Luc Harousseau  
 University Hospital Hotel Dieu  
 Hematology Department  
 1 Place A Ricordeau  
 Nantes Cedex, France 44000

Philippe Henon  
 Centre Hospitalier de Mulhouse  
 Hematology  
 87 Avenue d'Altkirch  
 Mulhouse, France 68100

Ronald Hoffman  
 University of Illinois College of  
 Medicine  
 Hematology/Oncology  
 900 South Ashland Ave.  
 Chicago, IL 60607

Louis Hudspeth  
 Berlex Laboratories  
 Scientific Affairs  
 10102 Sandbrook Hill  
 San Antonio, TX 788254

Christof von Kalle  
 University of Freiburg  
 Internal Medicine  
 Hugstetter Str. 55  
 Freiburg, Germany 79106

Ashwin Kashyap  
City of Hope National Medical Center  
Hematology/BMT  
1500 E Duarte Rd.  
Duarte, CA 91010

Armand Keating  
Princess Margaret Hospital  
610 University Ave.  
Toronto, Ontario, Canada M5G 2M9

Issa Khouri  
M.D. Anderson Cancer Center  
Blood and Marrow Transplantation  
1515 Holcombe Blvd.  
Houston, TX 77030

Gunnar Kvalheim  
The Norwegian Radium Hospital  
Department of Oncology  
Montebello  
Oslo, Norway 0310

Hillard Lazarus  
University Hospitals of Cleveland  
Department of Medicine  
11100 Euclid Ave.  
Cleveland, OH 44106

Jonathan Ledermann  
University College London  
Oncology  
91 Riding House St.  
London, UK W1P 8BT

Charles Linker  
UCSF  
Hematology/Oncology-BMT  
400 Parnassus Ave.  
San Francisco, CA 94143-0324

Deborah Livingston  
Nexell Therapeutics  
11224 Taylor Ct.  
West Windsor, NJ 08550

Kevin Longin  
Nexell Therapeutics Inc.  
2294 Puter Creek  
Spring Branch, TX 78020

Lawrence Lum  
Roger Williams Hospital  
Research Department  
825 Chalkstone Ave.  
Providence, RI 02908

Steve Mackinnon  
University College London  
Haematology  
98 Chenies Mews  
London, UK WC1E 6HX

Alberto Marmont  
S Martino Hospital  
Hematology  
P Rosanna Benzi 10  
Genova, Italy 16133

Massimo Martelli  
University of Perugia  
Hematology Department  
Via Brunamonti  
Perugia, PG Italy 06122

Hans Martin  
Klinikum der JW Goethe-Universitat  
Department of Hematology  
Theodor-Stern-Kai 7  
Frankfurt/Main, Germany D-60590

Giovanni Martinelli  
European Institute of Oncology  
Haematoncology  
Via Ripamonti, 435  
Milan, Italy 20141

Dana Matthews  
Fred Hutchinson Cancer Research  
Center  
Clinical Research-Pediatrics  
1100 Fairview Ave. N  
Seattle, WA 98109

Ian McNiece  
University of Colorado Health  
Sciences Center  
BMT Program  
4200 East 9th Ave.  
Denver, CO 80262

Peter McSweeney  
University of Colorado  
Bone Marrow Transplantation  
4200 Ninth Ave.  
Denver, CO 80262

Roland Mertelsmann  
Hematology-Oncology  
University Medical Center  
Hugstetter Str. 55  
Freiburg, Germany 79106

Carole Miller  
Johns Hopkins Oncology Center  
Oncology  
1650 Orleans St., Rm. 214-88  
Baltimore, MD 21231-1000

Annemarie Moseley  
Osiris Therapeutics, Inc.  
2001 Aliceanna St.  
Baltimore, MD 21231-3043

Petra Muus  
University Hospital Nijmegen (AZN)  
Department of Haematology  
Geert Groote Plein 8  
Nijmegen, The Netherlands 6500 HB

Paul O'Donnell  
Johns Hopkins Oncology Center  
Oncology  
550 N Broadway, Rm. 807  
Baltimore, MD 21205

Adolfo Porcellini  
Largo/S. Giorgio 2  
Noale, Venice, Italy 30033

Syed Quadri  
National Institutes of Health  
6701 Rockledge Dr.  
Bethesda, MD 20892

Azra Raza  
Rush-Presbyterian-St. Lukes Medical  
Center  
Rush Cancer Institute  
2242 W Harrison St.  
Chicago, IL 60612-3515

Stanley Riddell  
Fred Hutchinson Cancer Research  
Center  
Immunology  
1100 Fairview North  
Seattle, WA 98109



Vittorio Rizzoli  
University of Parma  
Hematology  
Via Gramsci 14  
Parma, Italy 43100

Sjoerd Rodenhuis  
Netherlands Cancer Institute  
Medical Oncology Department  
Pljmaailaan 121  
Amsterdam, The Netherlands 1066 CX

Amy Ross  
Nexell Therapeutics, Inc.  
Diagnostics  
9 Parker  
Irvine, CA 92618

Giovanni Rosti  
Ospedale Civile  
Oncology and Hematology  
Viale Randi 5  
Ravenna, Italy 48100

Jacob Rowe  
Rambam Medical Center  
Haifa, Israel 31096

David Schenkein  
Tufts-New England Medical Center  
Hematology/Oncology  
750 Washington St.  
Boston, MA 02111

Norbert Schmitz  
University of Kiel  
2nd Department of Internal Medicine  
Chemnitz Str.33  
Kiel, Germany D-24116

Scott Schuetz  
Fred Hutchinson Cancer Research  
Center  
Clinical Research Division  
1100 Fairview Ave. North  
Seattle, WA 98109

John Sharp  
University of Nebraska Medical Center  
Cell Biology and Anatomy  
986395 Nebraska Medical Center  
Omaha, NE 68198-6395

Jorge Sierra  
Hospital de la Santa Creu i Sant Pau  
Hematology  
St. Antoni M. Claret 167  
Barcelona, Spain 08021

Hanna Sovalat  
Hopital du Hasenrain  
IRHT  
87 Ave. D'Altkirch  
Mulhouse, France 68100

Thomas Spitzer  
Massachusetts General Hospital  
Medicine  
100 Blossom St.  
Boston, MA 02114

Anthony Stein  
City of Hope National Medical Center  
Hematology  
1500 East Duarte Rd.  
Duarte, CA 91010

Patrick Stiff  
Loyola University Medical Center  
Department of Medicine  
2160 S First Ave.  
Maywood, IL 60153

Rainer Storb  
Fred Hutchinson Cancer Research  
Center  
Transplantation Biology  
1100 Fairview Ave. North  
Seattle, WA 98109

John Sweetenham  
University of Colorado Health  
Sciences Center  
Division of Medical Oncology  
4200 East 9th Ave.  
Denver, CO 80262

John Tisdale  
National Institutes of Health-NIDDK  
MCHB  
Bldg. 10, Rm. 9N116  
Bethesda, MD 20892

Guido Tricot  
University of Arkansas for Medical  
Science  
MTRC  
4301 West Markham  
Little Rock, AR 72205

Richard Tsang  
Princess Margaret Hospital  
Radiation Oncology  
610 University Ave.  
Toronto, Ontario, Canada M5G 2M9

Alan Tyndall  
University of Basel  
Rheumatology  
Burgfelder Str. 101  
Basel, Switzerland 4012

Tehila Umiel  
IMPATH/BIS  
19231 Victory Blvd., Ste. 12  
Reseda, CA 91335

Dirk van Bekkum  
Introgene BV  
Wassenaarseweg 72  
Leiden, The Netherlands 2301 CA

Elisabeth Vandenberghe  
Central Sheffield University Hospitals  
Department of Haematology  
Glossop Rd.  
Sheffield, UK S10 2JF

Catherine Verfaillie  
University of Minnesota  
Stell Cell Institute  
420 Delaware St., SE  
Minneapolis, MN 55455

Judith Villablanca  
Childrens Hospital Los Angeles  
Hematology/Oncology  
4650 Sunset Blvd.  
Los Angeles, CA 90027

John Wagner  
University of Minnesota  
Pediatrics  
420 Delaware St. SE  
Minneapolis, MN 55455

Daniel Weisdorf  
University of Minnesota  
Department of Medicine  
BMT Program  
516 Delaware St. SE  
Minneapolis, MN 55455

Thomas Witzig  
Mayo Clinic  
Hematology  
Hilton 920, 200 First St. SW  
Rochester, MN 55905

Jurgen Wolf  
University of Cologne  
Internal Medicine I  
Josef Stelzmanastr. 9  
Koln, Germany 50924

Andrew Zelenetz  
Memorial Sloan Kettering Cancer  
Center  
Medicine  
1275 York Ave.  
New York, NY 10021

## AUTHOR INDEX

Acute Leukaemia		Cariello, Anna	151	Donahue, R.A.	285
Working Party		Carreras, E.	372	Douay, L.	604
of the EBMT	422, 439	Case, Delvyn	407	Druker, Brian J.	398
Agee, Gretchen	213	Cassileth, Peter	573	Du, J.	599
Akatsuka, Yoshiki	333	Cavaliere, Marina	387	Dunbar, C.E.	285
Alexander, Steve	321	Cavo, M.	480	Dunbar, Cynthia	297
Allampallam, Krishnan	302	Champlin, Richard	346	Eary, Janet	229
Almeida-Porada, G.	599	Chan, Wing C.	617	Elfenbein, Gerald	487, 590
Alvi, Sairah	302	Chauncey, Thomas	315	Elias, Anthony	135
Anderson, Kenneth C.	463	Childs, Richard	340	Engert, Andrfeas	560
Anker, Gunn	653	Chopra, R.	545	Erikstein, Bjørn	653
Appelbaum,		Cinieri, Saverio	62	Espinoza, Froilan P.	672
Frederick R.	229	Cocorocchio, Emilia	62	European Group for	
Apperley, J.	480	Colby, Christine	321	Blood and Marrow	
Arber, Daniel	450	Conde, E.	567	Transplantation	203, 480
Armitage, James O.	617	Cornelissen, J.	480	EBMT Autoimmune	
Arnold, Andrew	106	Corsetti, Maria Teresa	387	Disease Working	
Bacigalupo, A.	480	Couban, Stephen	106	Party	206
Badell, I.	372	Crilley, Pamela	407	EBMT Solid Tumors	
Baglietto, Laura	62	Crofford, Leslie	213	Working Party Breast	
Baldomero, Helen	151	Crown, John	41	Cancer Registry	41
Barlogie, Bart	473	Crump, Michael	106, 507	European League Against	
Barrett, John	340, 691	Dagis, Andrew	450	Rheumatism	203
Bauer, Kenneth D.	672	Damon, Lloyd E.	407	Facon, T.	480
Beijnen, Jos H.	87	Dansey, Janet	106	Falvey, Mary	487, 590
Bernstein, Irwin D.	229	Dansey, Roger	213	Fassas, Athanasios	206
Bertolini, Francesco	62	Dazzi, Claudio	41	Ferrante, Patrizia	41, 151
Bierman, Philip J.	534, 617	De Giorgi, Ugo	113, 151	Ferrucci, Pier Francesco	62
Bjorkstrand, B.	480	de la Rubia, Javier	428	Field, Teresa	52
Blade, J.	480	de la Torre-Bueno,		Fields, Karen K.	52
Blume, Karl G.	315	Jose	672	Finlay, Jonathan	121
Blumenschein,		de Laurenzi, A.	480	Forman, Stephen J.	450
George R.	82	de Vries, Elisabeth G.E.	87	Fouillard, L.	422, 439
Bossy, Blaise	672	Decker, William J.	672	Franklin, Jeremy	560
Boyle, Terry	573	Dey, Bimal	321	Frassoni, F.	422, 439
Brodsky, Isadore	407	Dharan, Bernie	380	Freytes, César O.	534
Brossart, Peter	15	Dicke, K.A.	30	Friedman, Judah	579
Brugger, Wolfram	15	Dicke,	76, 82,	Fulbright, Lorene K.	354
Brunet, S.	372	Karel A.	354	Furst, Daniel E.	213
Canals, C.	372	Diehl, Volker	560	Gahrton, G.	480
Carella, Angelo		Diel, Ingo J.	672	Garderet, L.	439
Michele	387	Djulbegovic, Benjamin	52	Gardner, Sharon	121

Gavin, Marc	333	Koç, Omer N.	579	McDonough, Kevin	213
Gee, Adrian P.	19	Kolstad, Arne	653	McNiece, Ian	3
George, Sebastian	662	Kröger, Nicolaus	71	McSweeney,	
Georges, George	315	Krüger, William	71	Peter A.	213, 315
Gerbing, Robert	166	Kvalheim, Gunnar	653	Michallet, M.	480
German Hodgkin's		Labopin, M.	422, 439	Miller, Kenneth B.	573
Lymphoma Study		Lazarus,		Mills, Bonnie	640
Group	560	Hillard M.	534, 573, 579	Milone, Gustavo	534
Giralt, Sergio	346	Ledermann,		Mitsky, Peggie	640
Gisselbrecht, C.	567	Jonathan A.	157	Molina, Arthur	315
Glimm, Hanno	297	Lemischka, I.R.	599	Montserrat, E.	372
Glück, Stefan	106	Lerma, Enrica	387	Moore, K.A.	599
Goldberg, Stuart	590	Levine, Mark	106	Morelli, Julie	573
Goldhirsch, Aron	62	Lewis, I.D.	599	Morgan, Deborah	487, 590
Goldstein, Steve	52	Linker, Charles A.	407	Morr, Jody	573
Goldstone, A.	567	Liu, H.	599	Moss, Thomas J.	662
Gorin, N.C.	422, 439	Livingston, D.L.	30	Mundle, Suneel	302
Greenberg, Philip D.	333	Livingston,		Muñoz, L.	372
Guilhot, F.	567	Deborah L.	354	Murata, Makoto	333
Haarstad, Helge	653	Ljungman, P.	480	Nascimben, Fabiana	302
Hamblin, T.J.	249	Loberiza, Fausto R.	534	Nash, Richard A.	213, 315
Hanks, Sylvia	354	Lopez-Guillermo, E.	567	National Collaborative	
Harrington, Douglas S.	672	Ludmann, Susan	672	Study for Stem Cell	
Hawes, Debra	672	Lum, Lawrence G.	95	Transplantation in Auto-	
Hilger, Jacqueline	450	Lum, Lawrence	487	immune Diseases	213
Hoffmann, Gesa	297	Lynch, James C.	617	Navarro, Willis	407
Holmberg, Leona	213	Mackinnon, Stephen	243	Nesland, Jahn M.	653
Horowitz, Mary M.	534	Malik, Shahid	487, 590	Niederwieser, D.	480
Horowitz, Mary	380	Maloney,		Niederwieser, Dietger	315
International Stem		David G.	267, 315	O'Donnell,	
Cell Database	203	Marangolo,		Margaret R.	450
Isaacson, P.	567	Maurizio	41, 113, 151	O'Reilly, Susan	106
Joyce, Robert	662	Maris, Michael	315	Ofstein, Ginny	640
Julià, A.	372	Marlin, Susan	106	Olivé, T.	372
Kang, E.M.	285	Marmont, Alberto M.	183	Ortega, J.J.	372
Kashyap, Ashwin	219	Martelli, Massimo	401	Otte, Marcus	629
Keating, Armand	507	Martinelli, Giovanni	62	Pantel, Klaus	629
Kelly, Donna	267	Masih, Aneal S.	672	Papiani, Giorgio	151
Kessinger, Anne	617	Matthay, Katherine K.	166	Partyka, James	52
Khoury, Issa	346	Matthews, Dana C.	229	Passweg, Jakob	219
Kim, H.J.	285	Mayes, Maureen	213	Paulus, Ursula	560
Kim, Hyeoung	297	Mayorga, Jami	354	Pavlovsky, Santiago	534
King, C.A.	249	Mazzarol, Giovanni	62	Peccatori, Fedro	62
Kirkbride, Peter	106	McAfee, Steven	321	Pecora, Andrew	573, 590

- |                      |              |                     |          |                        |          |
|----------------------|--------------|---------------------|----------|------------------------|----------|
| Perkins, Janelle B.  | 52           | Schmidt, A.         | 599      | Tricot, Guido          | 473      |
| Phillips, Gordon L.  | 534          | Schmidt, Manfred    | 297      | Tsai, Tsuong W.        | 534      |
| Powles, R.           | 480          | Schmitz, N.         | 567      | Tsang, Richard W.      | 495      |
| Prather, Kathy       | 213          | Schuetze, Scott M.  | 267      | Tu, Dongsheng          | 106      |
| Preffer, Frederic    | 321          | Seeger, Robert C.   | 166      | Tuchman, S.A.          | 285      |
| Preti, Robert        | 590          | Segura, Tamika      | 640      | Tura, S.               | 480      |
| Priddy, Carl         | 672          | Sellers, S.E.       | 285      | Tyndall, Alan          | 203, 219 |
| Pritchard, Kathleen  | 106          | Shaher, Ahmad       | 302      | Umiel, Tehila          | 662      |
| Prosper, Felipe      | 41           | Sharp, J. Graham    | 617      | Vaccari, Daniella      | 62       |
| Raza, Azra           | 302          | Sharron, Amy        | 487      | van Besien, Koen       | 534      |
| Reddy, Poluru        | 302          | Shepherd, Lois      | 106      | Vandenberghe, E.       | 567      |
| Reece, Donna E.      | 534          | Shetty, Vilasini    | 302      | Venugopal,             |          |
| Reed, Elizabeth C.   | 617          | Shizuru, Judith     | 315      | Parameswaran           | 302      |
| Reiffers, J.         | 480          | Shpall, E.J.        | 3        | Verdonck, L.F.         | 480      |
| Reynolds, C. Patrick | 166          | Sierra, J.          | 372      | Verfaillie, C.M.       | 599      |
| Ribera, J.M.         | 372          | Sievers, Eric L.    | 229      | Vernant, J.P.          | 480      |
| Rice, J.             | 249          | Slovak, Marilyn S.  | 450      | Veronesi, Paolo        | 62       |
| Riddell, Stanley R.  | 333          | Smith, Anne         | 106      | Vesole, David H.       | 534      |
| Ries, Curt A.        | 407          | Smith, Barbara E.   | 267      | Viganego, Federico     | 213      |
| Ringden, O.          | 439          | Sniecinski, Irena   | 450      | Villablanca, Judith G. | 166      |
| Roberts, Todd        | 507          | Sommer, Hilde       | 653      | Volin, L.              | 480      |
| Robertson, J.D.      | 545          | Spellerberg, M.B.   | 249      | von Kalle, Christof    | 297      |
| Rodenhuis, Sjoerd    | 87           | Spitzer, Thomas R.  | 321      | Vora, Nayana           | 450      |
| Ross, Amy A.         | 640          | Stadtmauer, Edward  | 573      | Vose, Julie M.         | 534, 617 |
| Rosti,               |              | Stein, Anthony S.   | 450      | Wagner, J.E.           | 599      |
| Giovanni             | 41, 113, 151 | Stevenson, F.K.     | 249      | Warren, Edus H.        | 333      |
| Rovira, M.           | 372          | Stewart, Douglas    | 106      | Wazer, David E.        | 573      |
| Rowe, Jacob M.       | 361          | Stiff, Patrick J.   | 127, 697 | Weisdorf, Daniel       | 380      |
| Rubin, Arnold        | 407          | Storb, Rainer       | 315      | Willemze, R.           | 480      |
| Ruffner, Katherine   | 229          | Storek, Jan         | 213      | Wissler, Manuela       | 297      |
| Ruiz de Elvira, C.   | 567          | Stram, Daniel       | 166      | Witzig, Thomas E.      | 259      |
| Russell, N.H.        | 480          | Sullivan, Daniel    | 52       | Wolf, Jeffrey L.       | 407      |
| Ryan, Katherine      | 213          | Sullivan, Keith M.  | 213      | Wolf, Jürgen           | 560      |
| Sachs, David H.      | 321          | Svensson, H.        | 480      | Woo, Doni              | 450      |
| Sackstein, Robert    | 321          | Sweetenham, John W. | 519      | Woolfrey, Ann          | 315      |
| Sahota, S.S.         | 249          | Sykes, Megan        | 321      | Wu, T.                 | 285      |
| Saidman, Susan       | 321          | Tarantolo, Stefano  | 617      | Wu, Tong               | 297      |
| Samson, D.           | 480          | Tareen, Mona        | 302      | Yamamoto, Karen        | 672      |
| Sandmaier, Brenda M. | 315          | Theunissen, K.      | 599      | Zamkoff, Ken           | 407      |
| Sanz, M.A.           | 428          | Tisdale, J.F.       | 285      | Zander, Axel Rolf      | 71       |
| Schaefer, U.W.       | 480          | Tisdale, John       | 297      | Zanjani, E.D.          | 599      |
| Schattenberg, A.     | 480          | To, Vu              | 640      | Zaucha, Jan M.         | 315      |
| Scheller, C.         | 599          | Topolsky, David     | 407      | Zickler, Philipp       | 297      |
| Schenkein, David P.  | 573          | Traystman, Monica   | 617      | Zorat, Francesca       | 302      |

## KEY WORD INDEX

Activated T cells	95	FLAG-Ida	346
Acute leukemia	439	Fludarabine	346
Acute lymphoblastic leukemia	361, 372, 380	Gene transfer methods	285
Acute myeloid leukemia	407, 422, 428, 450	Germ cell tumors	151
Adjuvant	71	Graft manipulation	19
Adjuvant therapy	653	Graft-vs.-host disease	333
Adoptive T-cell therapy	333	Graft-vs.-leukemia effect	315, 333
Allogeneic immunotherapy	340	Haploidentical transplants	401
Allogeneic transplant	480, 534	Hematological malignancies	691
Allotransplant	439	Hematopoietic cell culture	604
Antibody-targeted therapy	229	Hematopoietic stem cell	285
Autoimmune disease	183, 203, 213, 219	Hematopoietic stem cell transplantation	219
Autotransplant failure	243, 439, 534	Hematopoietic stem cells	297, 315
BEACOPP regimen	560	HER-2/neu	15
Brain tumors	121	High-dose chemotherapy	579
Breast cancer	41, 52, 62, 71, 87, 95, 106, 113, 640, 653, 662, 672	High-dose therapy	135
Cancer vaccines	15	Hodgkin's disease	495, 507, 519, 534, 545, 560, 579
CD34 <sup>+</sup> cells	401, 590	ICE regimen	62
Chemotherapy resistance modifiers	166	Image analysis	672
Chronic myeloid leukemia	387, 398	Immune therapy	95
Cord blood cells	604	Immunocytochemistry	629, 662
Cord blood progenitors	3	Immunotherapy	249, 267
CTC regimen	87	Interleukin-2	450
Detection	629	L-PAM	487
DNA vaccines	249	Large-volume leukapheresis	30
Dose intensive	135	Late complications	545
EBMT	41, 157, 203	Lymphoma	573, 579, 590
EBMT tumor registry	151	Mantle cell lymphoma	567
Elderly patients	422	Marrow cells	3
Epirubicin/paclitaxel	113	Melphalan	487
Ex vivo	3	Metastatic	52, 71
Ex vivo culture	599	Metastatic breast cancer	82
Ex vivo expanded cells	590	Micrometastases	629, 672
Ex vivo expansion	604	Mini-dose allogeneic transplant	354
		Minimal residual disease	629, 653, 662
		Minor histocompatibility antigens	333

Mixed chimerism	321	Retroviral gene transfer	297
Mobilization	30	Salvage chemotherapy	507
Mobilization regimen	113	Salvage therapy	519
MUC1	15	Sequential transplants	113
Multiple myeloma	267, 463, 473, 480, 487	Serum-free medium	604
Multiple sclerosis	206	Small cell lung cancer	135
Myelodysplastic syndrome	302	Solid tumors	697
NCIC CTG MA16	106	Stem cell	135
Neuroblastoma	166	Stem cell transplantation	579
Nonmyeloablative transplants	243, 315, 321, 340, 346	STI571	398
Outpatient allogeneic transplant	354	Stroma-free culture	599
Ovarian cancer	127, 157	Systemic sclerosis	213
Peptide-pulsed dendritic cells	15	TNT regimen	52
Peripheral blood cell transplants	428	Tolerance	401
Ph <sup>+</sup> ALL	372	Tumor cell contamination	617, 662
Primary breast cancer	76	Tumor cell detection	640
Progenitor cell expansion	604	Tumor cell purging	640
Prospective trials	71	Tyrosine kinase inhibitor	398
Radiation therapy	495, 573	Umbilical cord blood cells	599
Radioimmunotherapy	259	Unrelated donor transplant	380
Relapsed lymphoma	259	Yttrium-90 Zevalin	259
		Zevalin	259





ISBN 1-891524-08-9